



Yealink Network Technology CO., LTD

Yealink MVC II Series for Microsoft Teams Rooms Deployment Guide(V2.0)

Contents

Introduction.....	4
Hardware Overview.....	4
MCore.....	4
Camera-Hub.....	5
UVC80.....	6
UVC50.....	7
UVC30 Room.....	8
MTouch II.....	8
CPW90.....	9
MSpeaker II.....	9
CP900.....	10
VCR20 Remote Control.....	10
Related Documentations.....	12
Technical Specifications.....	12
Microsoft Teams Rooms.....	13
License Requirements for Using Microsoft Teams Rooms Features.....	14
Deployment and Connection.....	14
MVC900 II.....	15
MVC800 II.....	15
MVC500 II.....	16
MVC300 II.....	17
Recommended Deployment Solution.....	17
Deployment Solutions of Different Meeting Rooms.....	17
Camera Installation.....	21
Initial Setup.....	24
Skype User Account.....	24
Administrator User Account.....	25
Setting up Yealink MVC900 II/MVC800 II/MVC500 II/MVC300 II.....	25
Basic Settings of Teams Room Systems.....	26
Controlling UVC80/UVC50/UVC30 Room Camera.....	26
Enabling/Disabling Auto-framing.....	27
Controlling Room Camera Position.....	27
Resetting Room Camera to Home Position.....	27
Creating the Preset Position on the Yealink RoomConnect Plug-in.....	28
Setting Camera to Preset Position.....	28
Adjusting the Camera Layout of the MVC900 II System.....	28
Adjusting the Camera Layout When the System is Idle.....	29
Single and Dual External Display.....	29
Single Screen Layouts.....	29
Dual Screen Layouts.....	30
Enabling Dual Monitor Mode.....	30

Content Sharing.....	31
Wired Content Sharing.....	32
Wireless Content Sharing.....	32
Adjusting the MTouch II Lightness.....	33
Changing Sign-in Account.....	33
Basic Features for Microsoft Teams Rooms App.....	34
Switching Between Skype User Account And Administrator Account.....	35
Skype User Account Sign-in.....	35
Administrator Sign-in.....	35
Logging into Yealink Management Cloud Service/Yealink Device Management Platform.....	36
Troubleshooting.....	37
Upgrading System Software.....	37
Enabling Automatically Windows Update.....	37
Manually Windows Update.....	38
Firmware for Each Device.....	39
General Issues.....	40
Does the MVC900 II/MVC800 II/MVC500 II/MVC300 II Come with All the Necessary Software Pre-installed?.....	40
The Room Is Not Enabled for Teams Meetings.....	40
There Is No Content Displayed on the Second Display.....	40
Any Anti-virus Software Needed to Be Installed on the MCore?.....	41
Restarting the Device.....	41
Checking the Status of Your Device.....	42
Appendix.....	42

Introduction

Yealink MVC II Series is the brand-new video conferencing system released by Yealink that revolutionizes the Microsoft Teams Rooms collaboration experience. Perfectly integrated with Microsoft Teams Rooms and Yealink cutting-edge audio & video solutions, the Yealink MVC II Series is deemed to cover all the usage scenarios and provide you with the excellent collaboration experience in the conference room. Consisting of the touch console, content sharing unit, audio and video peripherals, and MCore, the Yealink MVC II Series enhances the whole meeting experience with the familiar Microsoft Teams Rooms interface and a close-to-zero learning curve, allowing you just to simply walk into the conference room and start your meeting with one-touch join, or type a few names and launch an ad hoc call.

The Yealink MVC900 II includes 1 camera hub and 2 powerful pan-tilt-zoom cameras with 12x optical zoom, to cover up an extra-large conference room.

The Yealink MVC800 II includes 3 VCM34 and a powerful pan-tilt-zoom camera with 12x optical zoom, to cover up a large conference room.

The Yealink MVC500 II include 2 CPW90 and a powerful pan-tilt-zoom camera with 5x optical zoom, to cover up a small-to-medium conference room.

The Yealink MVC300 II includes a UVC30 Room ultra HD 4K camera with auto framing feature and a CP900 HD full duplex speakerphone covering up to 7 people. MVC300 II is perfect suit for focus and small meeting room.

The MVC II system also supports connecting to the Yealink Management Cloud Service or Yealink Device Management Platform for unified management, as well as diagnosis and alarm for all devices in the MVC II system.

- [Hardware Overview](#)
- [Related Documentations](#)
- [Technical Specifications](#)
- [Microsoft Teams Rooms](#)

Hardware Overview

This chapter provides hardware overview.

- [MCore](#)
- [Camera-Hub](#)
- [UVC80](#)
- [UVC50](#)
- [UVC30 Room](#)
- [MTouch II](#)
- [CPW90](#)
- [MSpeaker II](#)
- [CP900](#)
- [VCR20 Remote Control](#)

MCore

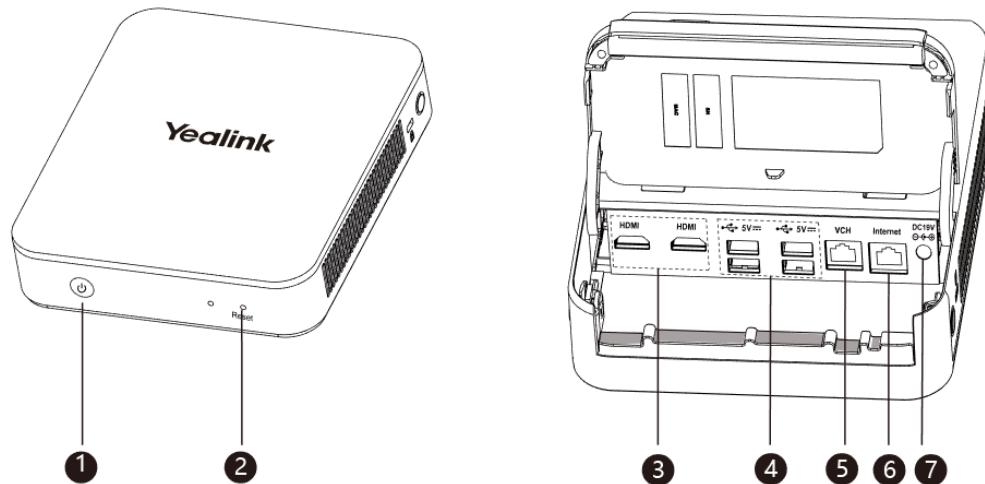

	Port Name	Description
①	Power	Powers on or powers off.
②	Reset Key	Reset the MCore to factory defaults.
③	HDMI	Connects to a display.
④	USB 3.0 Port	<ul style="list-style-type: none"> Connects to the UVC80/UVC50/UVC30 Room. Connects to a wireless USB dongle to use the wireless keyboard or the mouse. Connects to other USB devices.
⑤	VCH port	Connects to MTouch II.
⑥	Internet	Connects to the network device.
⑦	DC19V	Connects to the power adapter.

Camera-Hub

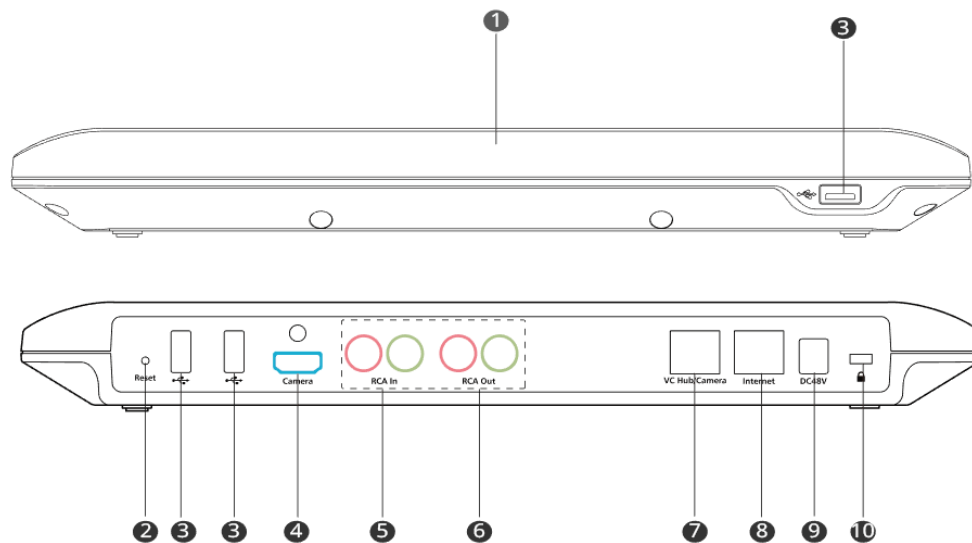

	Port Name	Description
1	LED Indicator	Indicate different status of the system.
2	Reset Key	Reset the system to factory defaults.
3	USB Port	/
4	Camera Port	/
5	RCA In	Connect to an audio input device via a RCA cable.
6	RCA Out	Connect to the MSpeaker II via a RCA cable.
7	VC Hub/Camera	Connect to the VCM34.
8	Internet	Connect to the switch to connect UVC80s.
9	DC48V	Connect to the power source via a power adapter.
10	Security Slot	Allow you to connect a universal security cable to the codec, so you can lock the codec down. The system cannot be removed when locked.

UVC80

The following describes the corresponding ports of UVC80:

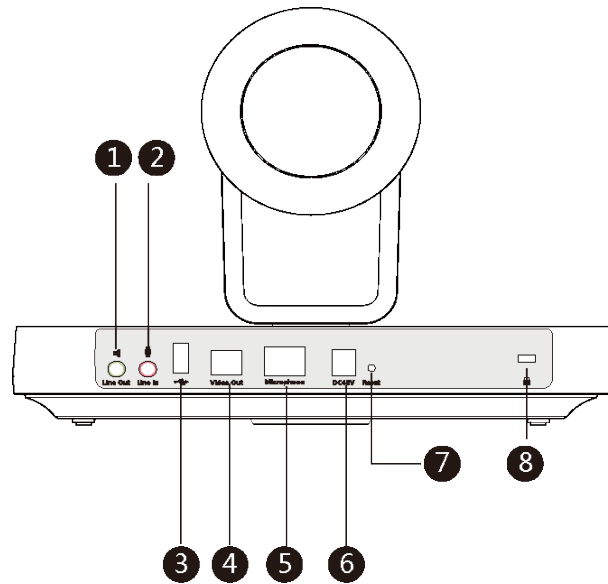

	Port Name	Description
①	Line Out	Connects to an audio output device using a 3.5mm audio cable (for example, MSpeaker II).
②	Line In	Connects to an audio input device using a 3.5mm audio cable.
③	USB	Inserts the DD10 to connect to the CPW90.
④	Video Out	Connects to a PC as a video output.
⑤	Microphone	Connects to the VCM34.
⑥	DC48V	Connects to the power adapter.
⑦	Reset	Resets the UVC80 to factory defaults.
⑧	Security Slot	Creates a secure connection to the UVC80 with a universal security cable to lock UVC80 down.

UVC50

The following describes the corresponding ports of UVC50:

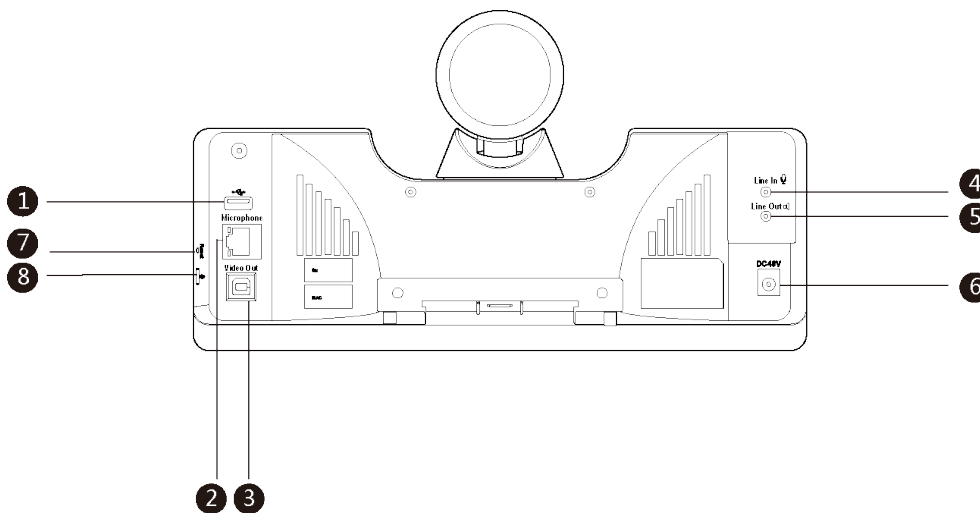

	Port Name	Description
①	USB	Inserts DD10 to connect to CPW90.
②	Microphone	Connects to VCM34.
③	Video Out	Connects to a PC as a video output.
④	Line In	Connects to an audio input device using a 3.5mm audio cable.
⑤	Line Out	Connects to an audio output device using a 3.5mm audio cable.
⑥	DC48V	Connects to the power adapter.
⑦	Reset	Resets the UVC50 to factory defaults.
⑧	Security slot	Creates a secure connection to the UVC50 with a universal security cable to lock UVC50 down.

UVC30 Room

The UVC30 Room is directly connected to the MCore via USB cable.

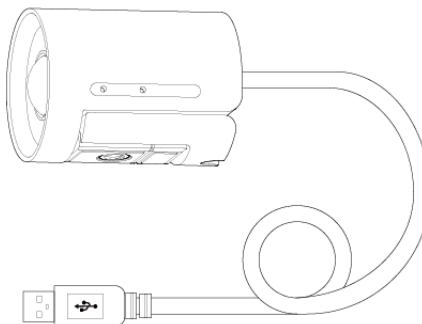

MTouch II

The following describes the corresponding ports of MTouch:

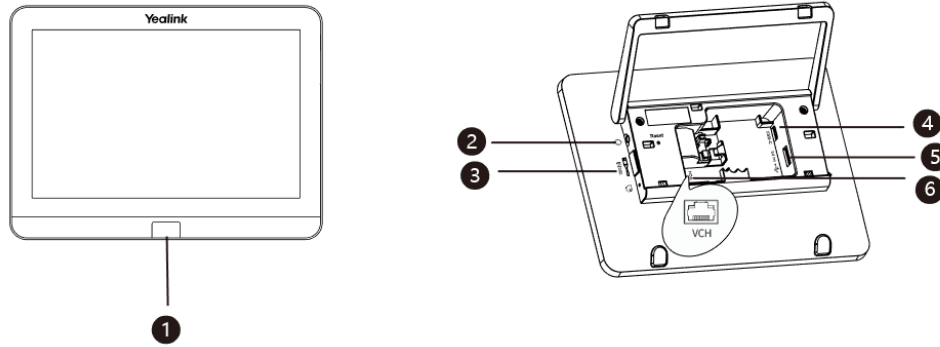

	Port Name	Description
①	Human Motion Sensor	Integrated in the front of the device, the motion detection sensor is to automatically wake up the Yealink MVC II system and light up the touch screen when the person approaches the touch screen.
②	3.5mm Headset	Connects to a headset.
③	USB-A port	Connects to the WPP20 to pair with WPP20 for wireless sharing.
④	USB-C port	Connects to PC for wired content sharing.
⑤	USB-A port	Connects to a USB audio devices, for example, CP900.
⑥	VCH port	Connects to MCore and MTouch II is powered by MCore.

CPW90

The CPW90 supports 360-degree audio pickup at a radius of up to 3 meters.

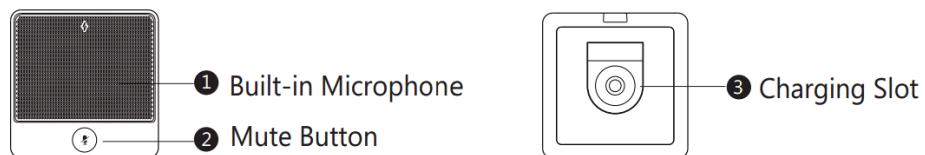

	Name	Description
①	Built-in Microphones	Supports 360-degree audio pickup at a radius of up to 3 meters.
②	Mute Button	<ul style="list-style-type: none"> Indicates registration status. Toggles mute feature.

MSpeaker II

The following describes the corresponding ports of MSpeaker II:

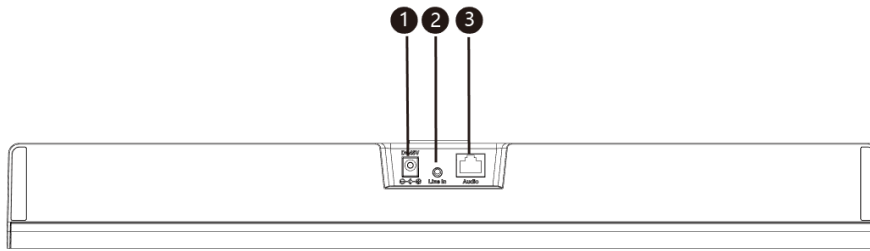

	Port Name	Description
①	DC48V	Connects to the power adapter.
②	Line In	Connects to UVC50/UVC80.
③	Audio	/

CP900

The CP900 is directly connected to the MCore via USB cable.

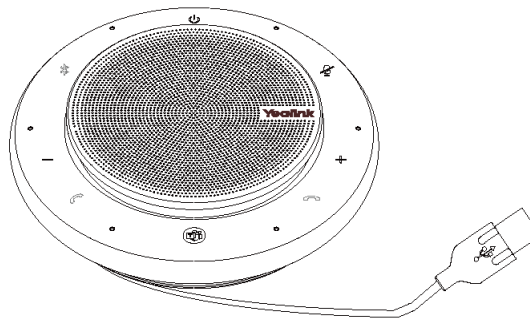

The following buttons are available during Skype for Business and Teams meetings:

	Button Name	Description
①	Power Button	Tap the power button for 3 seconds to power on or power off the CP900.
②	Volume Up/Down Button	Adjusts the volume of the CP900.
③	Mute Button	During a call, tap the mute button to mute or unmute.
④	Hang-up Button	End or reject a call.
⑤	Answer Button	Answer a call.

VCR20 Remote Control

The VCR20 remote control enables you to operate a MVC II system. This includes receiving meeting calls, controlling the camera, adjusting the volume and so on. The following table introduces the keys on the remote control.

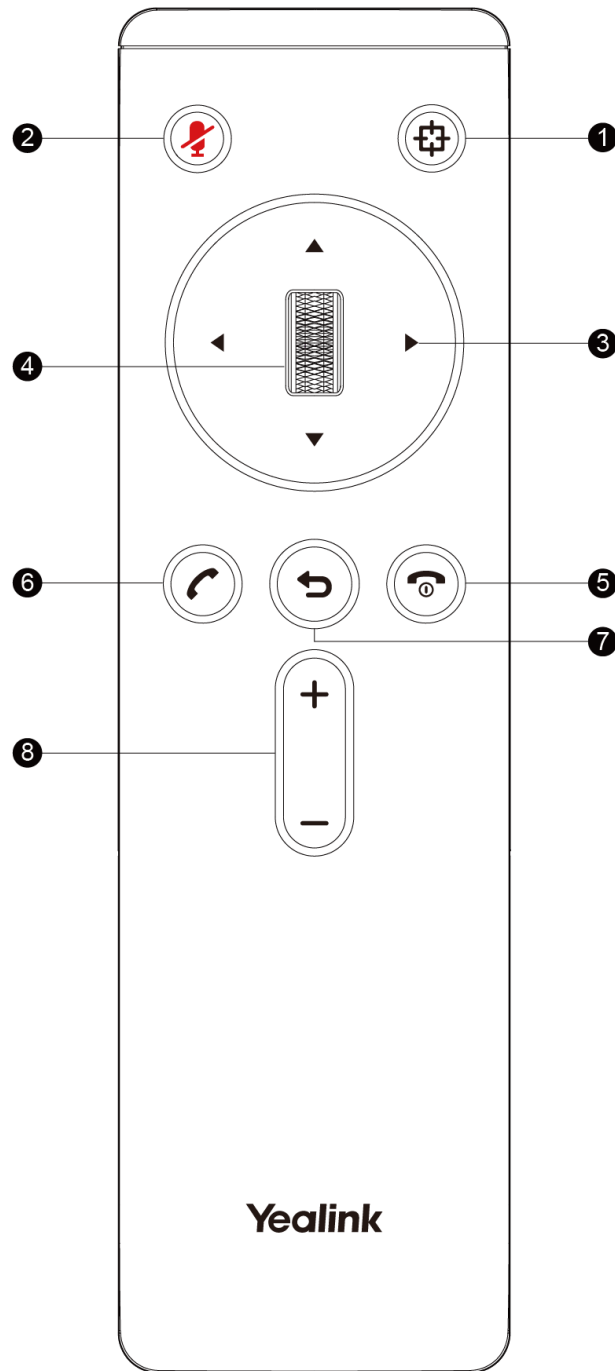

	Port Name	Description
①	Auto-framing Key	<ul style="list-style-type: none"> • Long press to enable/disable the auto-framing feature • Press to turn on/turn off auto-framing
②	Mute Key	Mute or unmute the microphone.
③	Navigation Key	Pan and tilt the camera to adjust the viewing angle.
④	Scroll Wheel (OK Key)	<ul style="list-style-type: none"> • Scroll up to zoom camera in. • Scroll down to zoom camera out.
⑤	On-hook Key	End a conference call.

	Port Name	Description
⑥	Off-hook Key	Answer a conference call.
⑦	Back key	
⑧	Volume key	Increase/decrease the volume.

Related Documentations

The following related documents are available:

- [Yealink MVCII Series for Microsoft Teams Rooms System Quick Start Guide \(EN, CN\)](#)
- [Yealink Camera-Hub Quick Start Guide\(EN&CN\)](#)
- [Yealink UVC80 Quick Start Guide\(EN&CN\)](#)
- [Yealink UVC50 Quick Start Guide\(EN&CN\)](#)
- [Yealink UVC30 Room Quick Start Guide \(EN, CN\)](#)
- [Yealink MTouchII Quick Start Guide \(EN, CN\)](#)
- [Yealink MSpeakerII Quick Start Guide \(EN,CN\)](#)
- [Yealink MCore Quick Start Guide \(EN, CN\)](#)
- [Yealink VCM34 Quick Start Guide\(EN&CN\)](#)
- [Yealink CP900 Quick Start Guide\(EN&CN\)](#)
- [Yealink Room Connect User Guide](#)

Technical Specifications

Operating System	Windows 10 IoT Enterprise (64-bit)
Software	Microsoft Teams Rooms
Processor / SSD / RAM	8th Gen Intel® Core™ i5/128GB/8GB (2 x 4GB)
Ports	<ul style="list-style-type: none"> • 2 x HDMI video output • Bluetooth and Wi-Fi • 4 x USB3.0 Type-A • 1 x 10/100/1000M Ethernet port • 1 x Power port
Buttons	Power On button on the front
MTouch II	<ul style="list-style-type: none"> • 8-inch IPS screen • 1280 x 800 resolution • 3.5mm headset jack • Human Motion Sensor • Angle adjustable bracket (28° ~ 50°) • 1080P/30FPS FHD • Built-in Wi-Fi AP for Yealink wireless presentation device • Support wired and wireless content sharing • HDMI/USB-C HD video input

Camera-Hub	<ul style="list-style-type: none"> • Support up to 9 cameras • 1 x RCA-in • 1 x RCA-out • 1 x Yealink Microphone port (RJ-45) • 3 x USB 2.0 Type-A
UVC80	<ul style="list-style-type: none"> • 1920 x 1080 video resolution • 60 frame rate • 12x optical zoom • Field of view (diagonal): 78.5° • Pan angle range: 200° • Tilt angle range: 60°
UVC50	<ul style="list-style-type: none"> • 1920 x 1080 video resolution • 60 frame rate • 5x optical zoom • Field of view (diagonal): 91° • Pan range: 60° • Tilt range: 40°
UVC30 Room	<ul style="list-style-type: none"> • 4K video resolution • Maximum 60FPS • 3x digital zoom • Field of view (diagonal): 120° • Facial detection and Auto framing • 1 x 3m USB 2.0 cable
MSpeaker II	<ul style="list-style-type: none"> • RMS: 10W • Frequent response: 100 Hz - 20K Hz • S/N: ≥ 70 dB • 1x Yealink VCH port • 1 x Line-out (3.5mm)
CPW90	<ul style="list-style-type: none"> • Built-in 3-microphone array • 20ft (6m) and 360° voice pickup range • Yealink Noise Proof Technology • Power over Ethernet (PoE) • Up to 4 units can be cascaded
CP900	<ul style="list-style-type: none"> • Optima HD voice • Signal to Noise Ratio (SNR): +59 dB • 6.5 feet / 2 meters voice pickup range • Full-duplex technology • Noise suppression (NS)

Microsoft Teams Rooms

Microsoft Teams Rooms is Microsoft's latest conferencing solution designed to bring a rich, collaborative experience into your meeting room. You will enjoy its familiar Skype for Business and Teams interface and IT administrators will appreciate an easily deployed and managed Windows 10 Skype Meeting app. Microsoft Teams Rooms is designed to leverage existing equipment like LCD panels for ease of installation to bring Skype for Business and Teams into your meeting room. And the system provides a complete meeting experience that brings HD video, audio, and content sharing to meetings of all sizes, from small huddle areas to large conference rooms.

More information available, please visit the [Microsoft Teams Rooms](#).

- [License Requirements for Using Microsoft Teams Rooms Features](#)

License Requirements for Using Microsoft Teams Rooms Features

The following table lists the licensing-dependant features that are available in Microsoft Teams Rooms and what licenses you need to buy to get them.

Microsoft Teams Rooms scenario	You have Microsoft Teams or Skype for Business Online Here's what you need to buy	You have Skype for Business Server 2015 (on-premises or hybrid).
Join a scheduled meeting	Meeting Room SKU	Skype for Business Server Standard CAL
Initiate an ad-hoc meeting	Meeting Room SKU	Skype for Business Server Standard CAL Skype for Business Server Enterprise CAL
Initiate an ad-hoc meeting and dial out from a meeting to phone numbers	Meeting Room SKU	Skype for Business Standard CAL Skype for Business Server Enterprise CAL
Give the room a phone number and make or receive a calls from the room or join an audio conference using a phone number	Meeting Room SKU	Skype for Business Server Standard CAL Skype for Business Server Plus CAL
Manage your room device with Microsoft Intune	Meeting Room SKU	Microsoft Intune subscription with <i>on premise MDM</i>

For more informaton on Microsoft Teams Rooms licenses, please refer to [Teams Meeting Room Licensing Update](#).

Deployment and Connection

The following contents describe the deployment and connection of MVC900 II, MVC800 II, MVC500 II, and MVC300 II.



Note: Make sure the display device is connected first. When starting up the system for the first time, you need to connect a mouse to complete the initial configuration (For MVC300 II, you need to connect a USB hub to use the mouse). We recommend using the wireless mouse kit.

- [MVC900 II](#)
- [MVC800 II](#)
- [MVC500 II](#)
- [MVC300 II](#)
- [Recommended Deployment Solution](#)

MVC900 II

The following is the deployment and connection of MVC900 II.

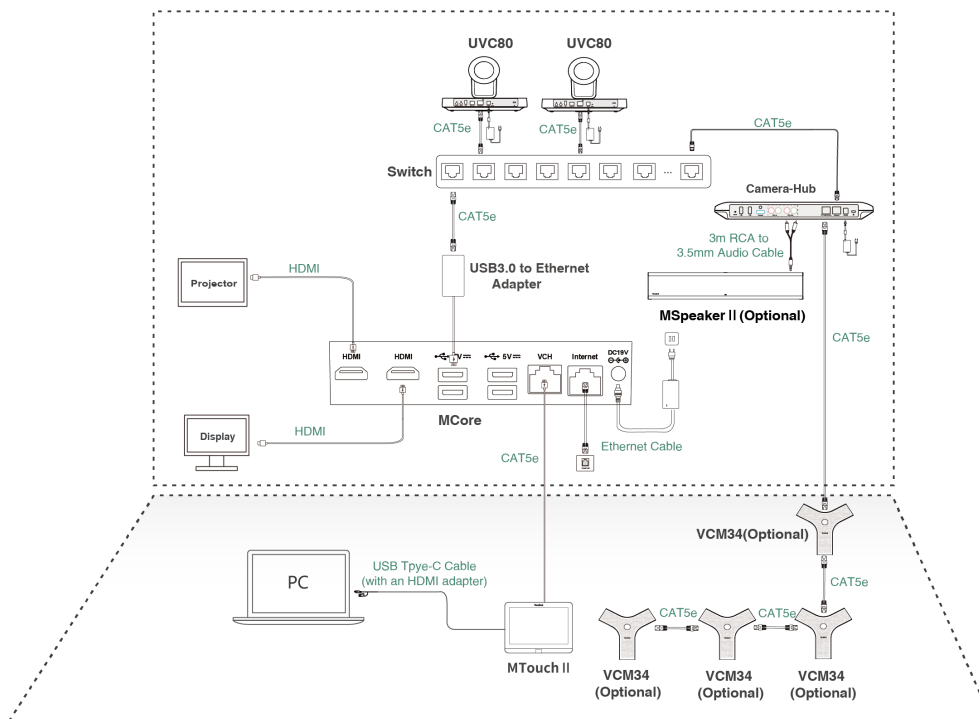

Note: For more information about the installation and deployment of accessories (for example, the installation of MCore or Camera-Hub), refer to the Quick Start Guide of the corresponding accessory.

MVC800 II

The following is the deployment and connection of MVC800 II.

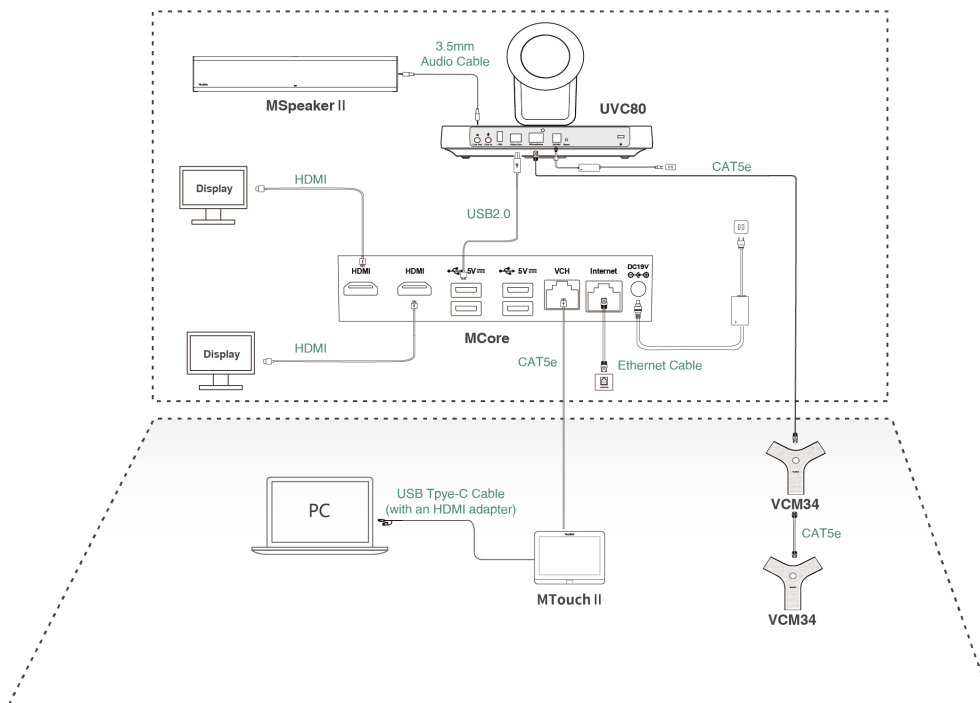

 **Note:** For more information about the installation and deployment of accessories (for example, the installation of MCore or UVC80 camera), refer to the Quick Start Guide of the corresponding accessory.

MVC500 II

The following is the deployment and connection of MVC500 II.

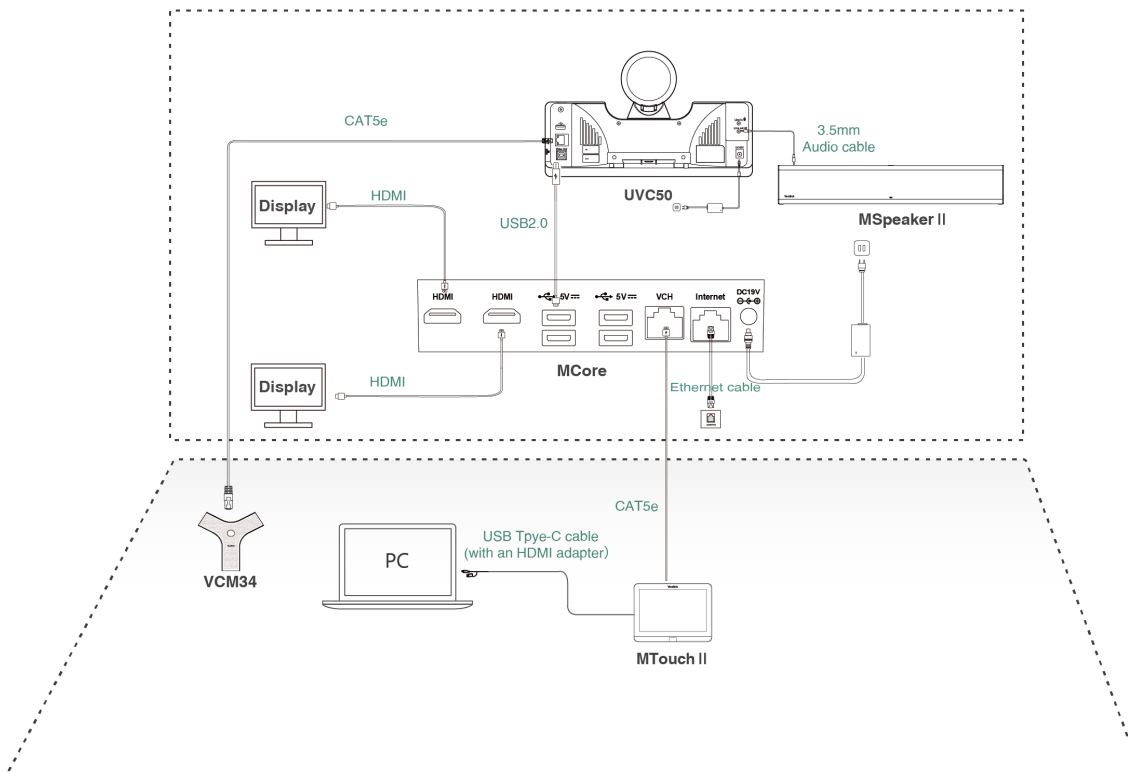



Note: For more information about the installation and deployment of accessories (for example, the installation of MCore or UVC50 camera), refer to the Quick Start Guide of the corresponding accessory.

MVC300 II

The following is the deployment and connection of MVC300 II.

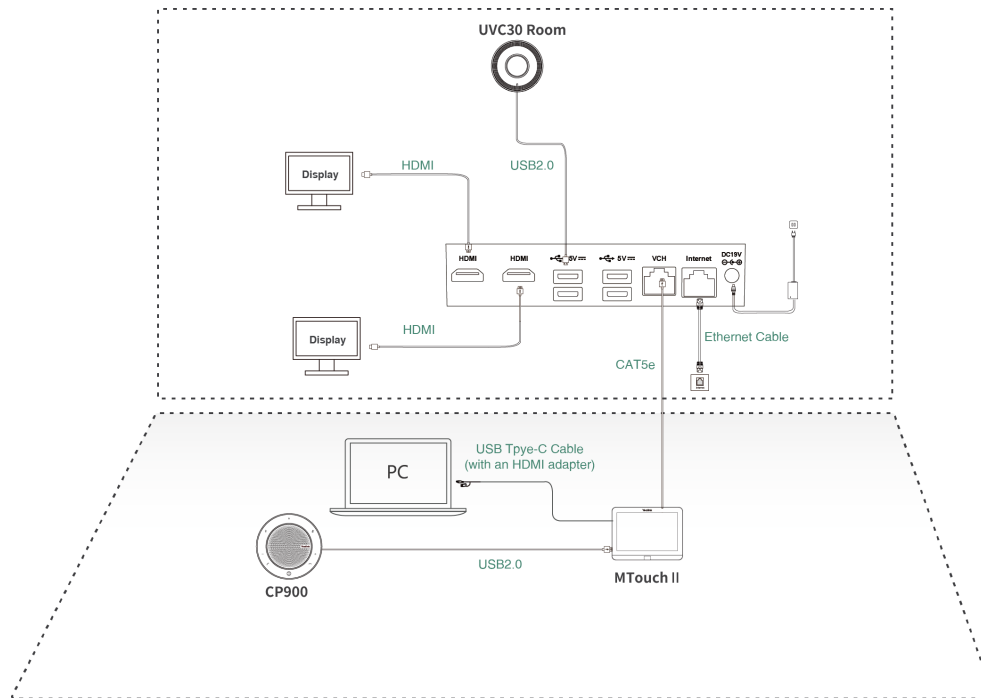





Note: For more information about the installation and deployment of accessories (for example, the installation of MCore or UVC30 Room camera), refer to the Quick Start Guide of the corresponding accessory.

Recommended Deployment Solution

- [Deployment Solutions of Different Meeting Rooms](#)
- [Camera Installation](#)

Deployment Solutions of Different Meeting Rooms

Yealink MVC900 II/MVC800 II/MVC500 II/MVC300 II system supports different camera devices (Camera-Hub/UVC50/UVC80/UVC30 Room) and audio devices (VCM34/MSpeaker II/CP900) according to the conference requirements. Deployment solutions for different camera devices and audio input devices are as follows:

Meeting Room Type	MVC II System	Devices Included
Extra-large room (18-30 People)	MVC900 II	
Medium-to-large room (13-20 People)	MVC800 II	
Small meeting room (4-12 People)	MVC500 II	
Focus and small room (2-7 People)	MVC300 II	

For Focus and small room (2-7 People)

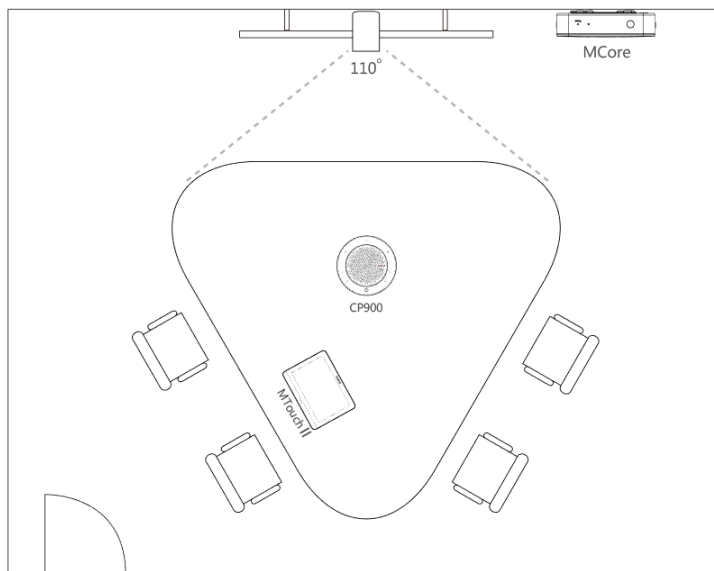

For Small meeting room (4-12 people)

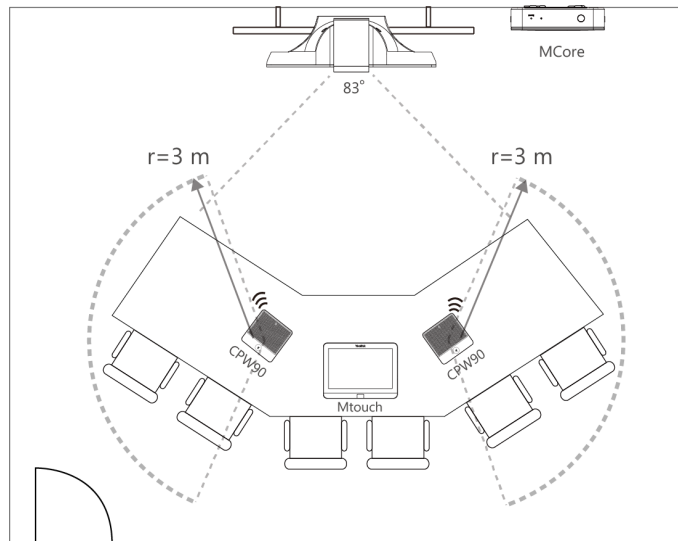

- CPW90 wireless microphones support 360-degree audio pickup at a radius of up to 3 meters.
- Place the CPW90 wireless microphones on a stable surface and keep them away from obstacles, so that they can pick up sounds effectively

For Medium-to-large conference room (13-20 people)

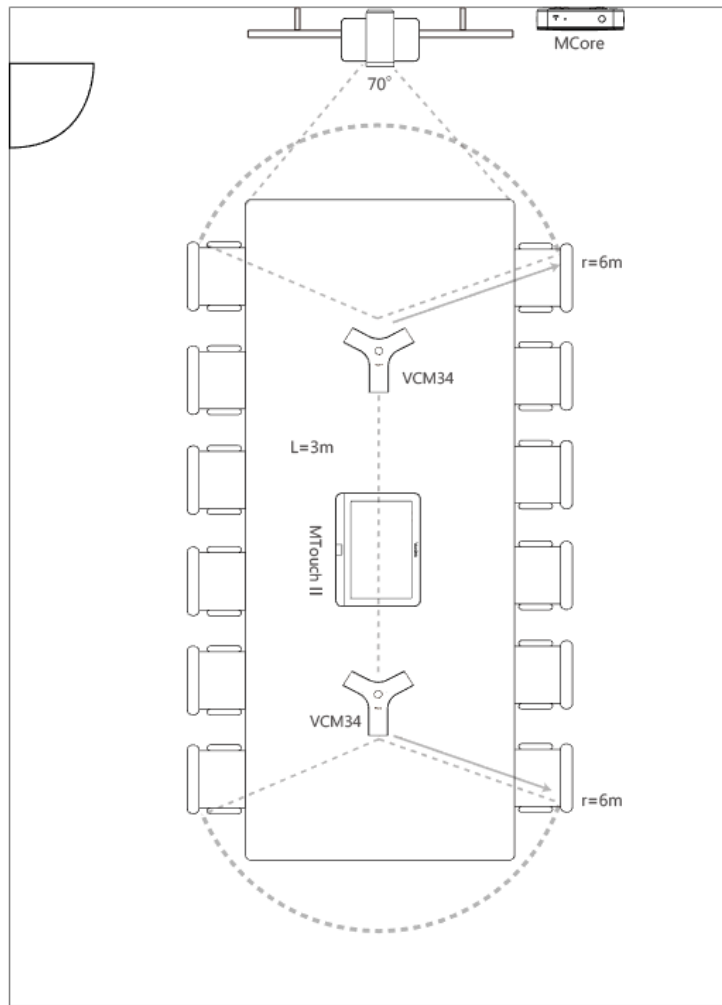

- The distance between the two VCM34s is 3 meters.
- VCM34 supports 360-degree audio pickup at a radius of up to 6 meters and you can cascade up to 4 VCM34 units.

For extra-large conference room (18-30 people)

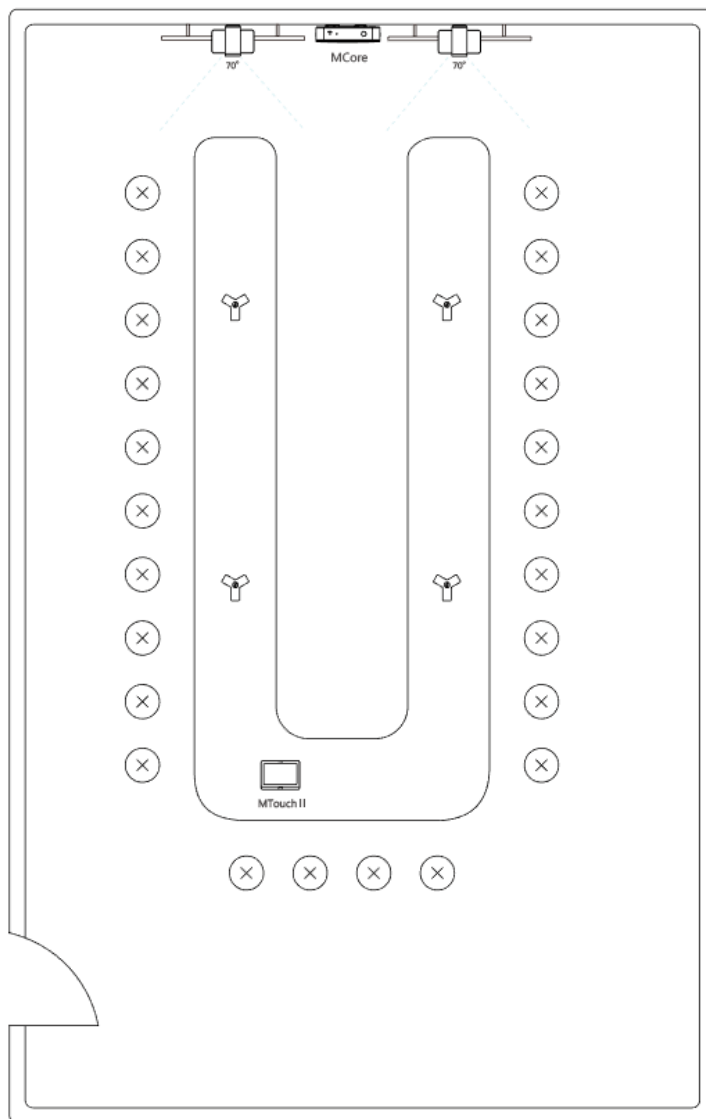

- The distance between the two VCM34s on both sides is 3 meters.
- VCM34 supports 360-degree audio pickup at a radius of up to 6 meters and you can cascade up to 4 VCM34 units.



Note: The MTouch II needs to be placed in a position facing the door.

Related concepts

[Recommended Deployment Solution](#)

Camera Installation

You can mount the UVC80/UVC50 on the top of the TV, on the wall, on the ceiling, or onto a TV Stand or a Tripod.

You can mount the UVC30 on the top of the TV, on the wall, or onto a TV Stand or a Tripod.

The installation methods are as follows:

For UVC80:

Mount on Top of a TV

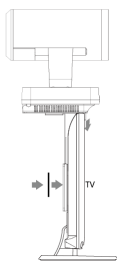

Mount on the Wall

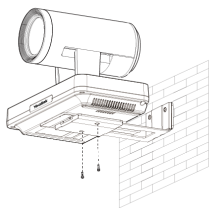

Mount on the Ceiling

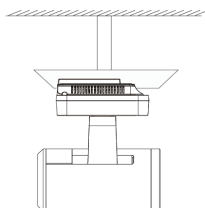

Mount onto a TV Stand or a Tripod

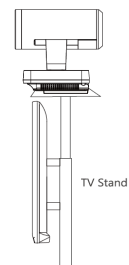

For UVC50:

Mount on the Top of the TV

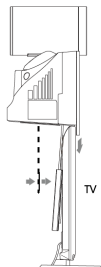

Mount on the Wall

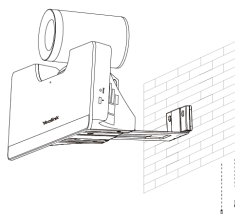

Mount on the Ceiling

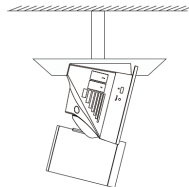

Mount onto a TV Stand or a Tripod

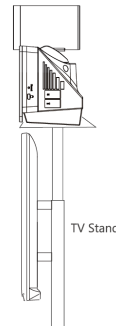

For UVC30:

Mount on Top of a TV

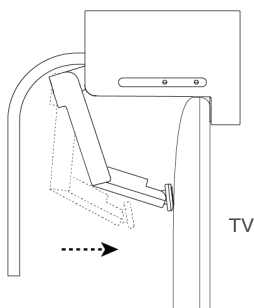

Mount on a Wall

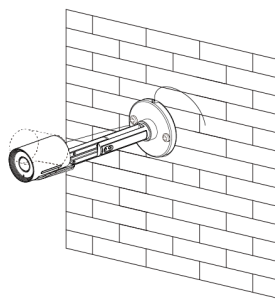

Mount onto a TV Stand or a Tripod

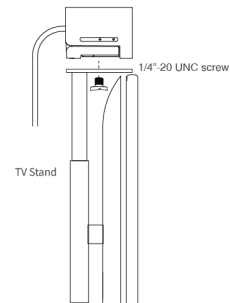

- [Recommendations of Camera Installation](#)
- [Recommendations of MSpeaker II Installation](#)
- [Recommendations of MCore Installation](#)
- [Conference Room Wiring](#)

Recommendations of Camera Installation

The following is an example of installing UVC80:

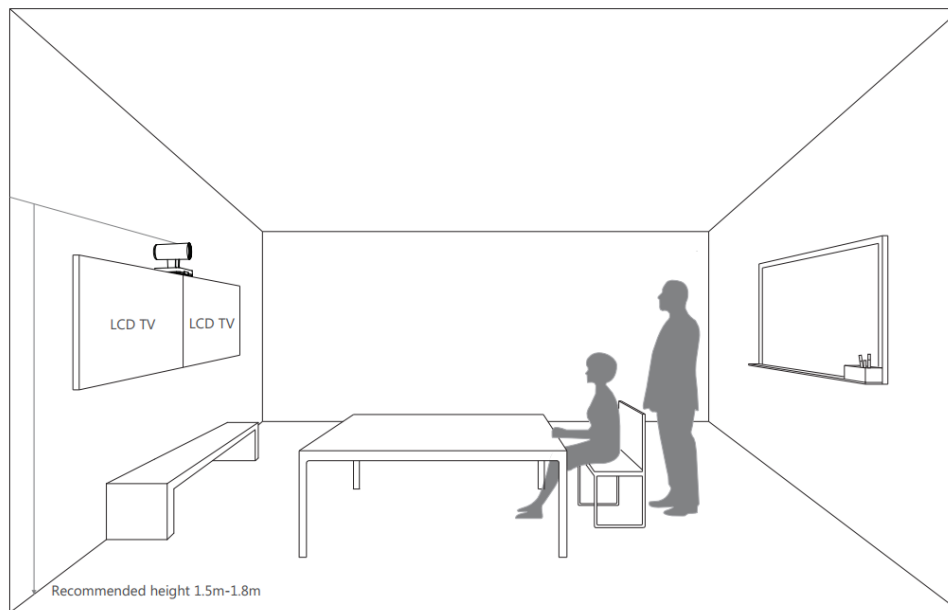

- Install the LCD TV and video camera relative to the center of the participants. Ensure that the participants face the camera and LCD TV directly during calls.
- The camera should be mounted on the wall, about 1.5 m to 1.8 m above the ground. Install the LCD TV below the camera.
- The camera should not face the light source directly, to prevent bad experience caused by dazzling light.

Recommendations of MSpeaker II Installation

Mount MSpeaker II on the wall as below:

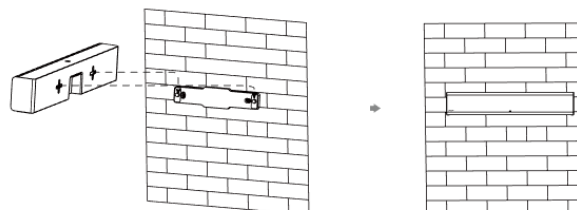

For more information about the installation of MSpeaker II, refer to [Yealink MSpeaker II Quick Start Guide \(EN, CN\)](#).

Recommendations of MCore Installation

You can mount the MCore on the wall near the TV, or stick it to the table or the backside of the TV cart.

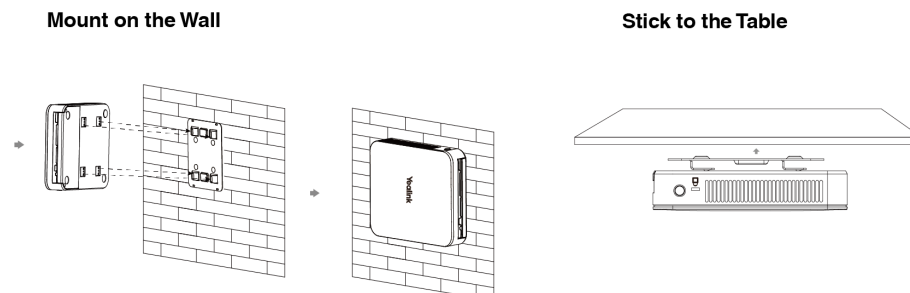

For more information on how to install the MCore, please refer to [Yealink Mcore Quick Start Guide \(EN,CN\)](#).

Conference Room Wiring

If the conference room has a dedicated routing channel, you can follow the way as it is. If not, follow the way below to route and fix the wire.

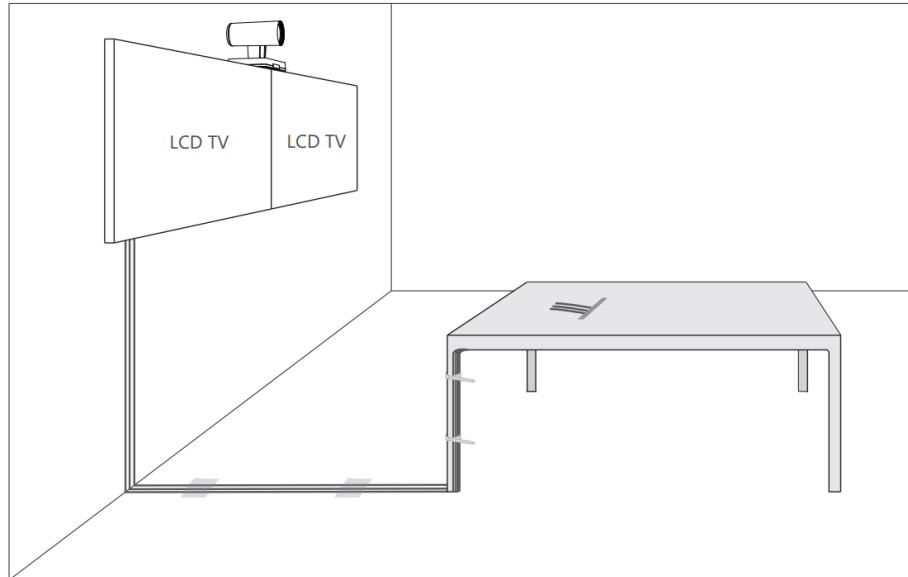

Note: If you require longer cable length for connecting the camera, you can use the USB extension cables for wiring.

Initial Setup

Once the MCore is powered on, the MCore will load the Microsoft Windows 10 IoT Enterprise operating system. By default, there are two Windows accounts (Skype user account and administrator user account) built into the MVC II system out of the factory.



Note: Before setting up the MVC II system, you need to connect a mouse to MCore to complete the initial configuration. We recommend using the wireless mouse kit.

- [Skype User Account](#)
- [Administrator User Account](#)

Skype User Account

Skype user account is the default account from which the Microsoft Teams Rooms app runs. This account is limited to running the Microsoft Teams Room app. This account is the default recommended account from which to run Microsoft Teams Room app without a password. No administrator privileges are available from this account.

The default account to run the Microsoft Teams Room is “Skype ” and this account will be automatically signed in when the system boots.

Administrator User Account

Administrator user account is privileged, meaning you can perform any action on the system, with minimal restriction (usually requiring a password for confirmation). The default password is “sfb” without quotes. For daily use such as Skype for Business meetings or Teams meetings, the administrator credentials are not needed. The admin account is only used for device management.

Related tasks

[Administrator Sign-in](#)

Setting up Yealink MVC900 II/MVC800 II/MVC500 II/MVC300 II

When the system is powered on, the device will automatically launch the Microsoft Teams Rooms app and enter the sign in screen. To use the device and basic features on the Teams Room Systems, you should finish the setup wizard first.

Before you begin

Make sure all components are connected correctly.

Procedure

1. Tap **Sign in** to enter the **Setup** screen.
2. Check the checkbox in the **EULA** page, and then tap **Next**.

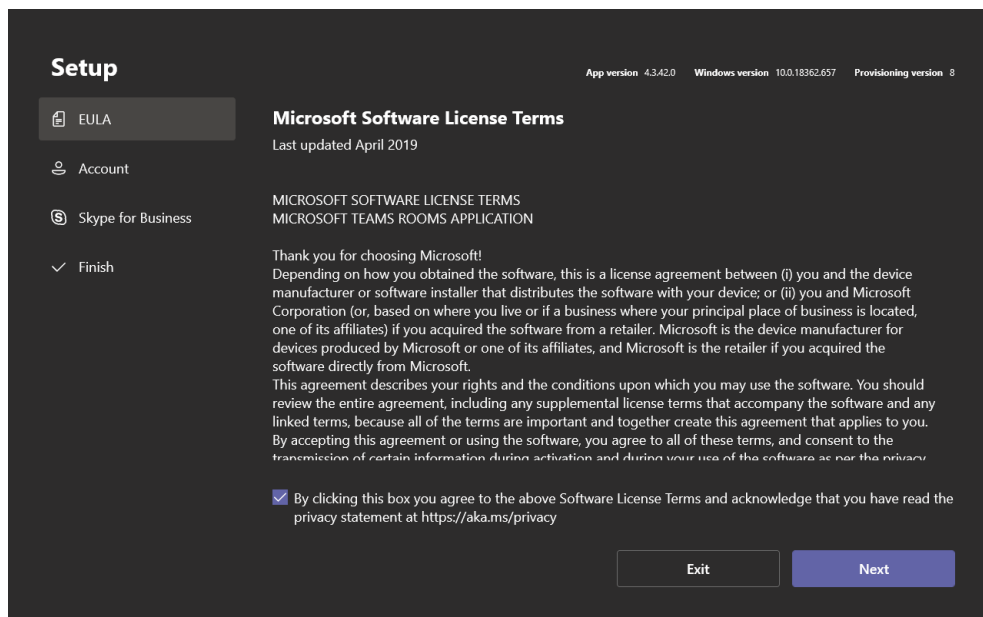

3. Enter the skype account, the password and re-enter the password in the **Account** page, and then tap **Next**.



Tip: If you want to use Teams meetings, you can choose the meeting mode to be **Skype for Business and Microsoft Teams (default)** in the **User Account** page.

4. Under "Configure domain" in the **Skype for Business** page, set the FQDN for the Skype for Business Server. If the Skype for Business SIP domain is different from the Exchange domain of the user, enter the Exchange domain in this field. and then tap **Next**.
5. Tap **Finish** to complete the setup wizard.

Basic Settings of Teams Room Systems

This section describes the following basic settings for the Teams Room Systems.

- [Controlling UVC80/UVC50/UVC30 Room Camera](#)
- [Adjusting the Camera Layout of the MVC900 II System](#)
- [Single and Dual External Display](#)
- [Content Sharing](#)
- [Adjusting the MTouch II Lightness](#)
- [Changing Sign-in Account](#)

Controlling UVC80/UVC50/UVC30 Room Camera

Microsoft Teams Rooms supports basic PTZ control for your UVC80/UVC50/UVC30 Room camera. In addition, you can use the preset position feature if you set up preset positions for your camera connected to the MVC II system on the Yealink RoomConnect plug-in.



Note: The Yealink RoomConnect plug-in running under Windows supports advanced settings for UVC80/UVC50/UVC30 Room cameras. After logging in to the Windows system as an administrator, you can configure the camera parameters including exposure, graphic , white balance mode, people counting (not applicable to MVC900 II system), and configuration hangup mode and camera pan direction.

For more information on how to configure camera parameters on the Yealink RoomConnect plug-in, please refer to [Yealink RoomConnect User Guide](#).

- [Enabling/Disabling Auto-framing](#)
- [Controlling Room Camera Position](#)
- [Resetting Room Camera to Home Position](#)
- [Creating the Preset Position on the Yealink RoomConnect Plug-in](#)
- [Setting Camera to Preset Position](#)

Enabling/Disabling Auto-framing

Auto-framing is mainly based on face detection, which provides real-time detection and position tracking on all faces in the conference room. All participants in the output screen are covered and the camera can be automatically adjusted according to the number of participants and the position changes.

About this task

When the auto-framing feature is enabled, you cannot control the UVC30 Room camera, but you can control the UVC80/UVC50 or use its preset position. After the UVC80/UVC50 is manually adjusted, the auto-framing feature is temporarily turned off. If you want to use it again, you need to press the auto-framing key on the remote control to turn it on.

Auto-framing is not applicable to MVC900 II system.

Procedure

1. Tap  to enter the **Camera Control** page.

If you are in a meeting, tap  > .

2. Select .
3. Enable/Disable the **Auto-framing**.

Related concepts





[VCR20 Remote Control](#)

Controlling Room Camera Position

Before you begin



Only when the auto-framing feature is disabled, can you control the UVC30 Room.

Procedure

1. Tap  to enter the **Camera Control** page.
If you are in a meeting, tap  > .
2. If you are using MVC900 II system, select a desired UVC80 camera.
3. Tap  /  to zoom camera out/in.
4. Tap the arrow keys to pan/tilt the camera.

Resetting Room Camera to Home Position

Procedure



1. Tap  to enter the **Camera Control** page.
If you are in a meeting, tap  > .
2. If you are using MVC900 II system, select a desired UVC80 camera.

3. Tap **Reset**.

Creating the Preset Position on the Yealink RoomConnect Plug-in

Presets specify the settings of both the angle and the focal length for the camera that can be used to quickly point a camera at a pre-defined location. And only administrators have permission to use Yealink RoomConnect.

Procedure

1. Sign in your MVC II system as an administrator.
2. Run the **Yealink RoomConnect** plug-in.
3. Tap the camera and then select **Preset Position**.
4. If you are using MVC900 II system, select a desired UVC80 camera.
5. Tap the navigation keys to adjust the camera angle.
6. Tap  or  to adjust the focal length.
7. Tap **New Preset** to create a new preset.



Note: If you are using the Yealink Room Connect for the first time, tap **Skip** to manage the devices locally. You can also manage the devices on the Yealink Device Management Platform or Yealink Management Cloud Service after signing into the remote management account.

For more information on how to use the Yealink RoomConnect plug-in, please refer to [Yealink RoomConnect User Guide](#).

Related tasks



[Administrator Sign-in](#)

Setting Camera to Preset Position

Before you begin

Preset positions have been added in the Yealink RoomConnect plug-in.

Procedure

1. Tap  to enter the **Camera Control** page.
If you are in a meeting, tap  > .
2. If you are using MVC900 II system, select a desired UVC80 camera.
3. Select a desired preset position.
The camera will be set to the preset position.

Related tasks

[Creating the Preset Position on the Yealink RoomConnect Plug-in](#)

Adjusting the Camera Layout of the MVC900 II System

After enabling the camera layout for Camera-Hub on the Yealink RoomConnect, you can adjust the camera layout of the MVC900 II system.

About this task

The MVC900 II system supports the following layouts:

- **Fullscreen:** the selected camera is displayed in full screen.

- **Division:** every camera is given equal prominence in equal-sized panes.
- **Surround:** the assigned camera is given prominence in the largest pane, and other cameras are displayed in a strip beside the assigned camera.

For more information on how to enable the camera layout feature for Camera-Hub on Yealink RoomConnect, please refer to [Yealink RoomConnect Userguide](#).

- [Adjusting the Camera Layout When the System is Idle](#)

Adjusting the Camera Layout When the System is Idle

Procedure

1. Tap  on the idle screen.

If you are in a meeting, tap  > .

2. Tap **Camera Layout**.

3. Select the desired layout and make the following settings:

- **Fullscreen:** Drag the camera from the camera list into the left picture to switch the camera displayed in full screen.
- **Division:** Drag the camera in the division mode to swap the camera display positions.
- **Surround:**

Select the desired mode from the drop-down menu to the right of the surround mode.

Drag the camera in surround mode to the specified position.

4. Tap **Apply**.

Single and Dual External Display

To fully enjoy video and content sharing in the meeting, at least one external display is recommended to be connected to the MCore. If you connect two external displays, the second screen will display the shared content in full screen.



Note: If you want to use two external displays, make sure the dual monitor mode is enabled.

- [Single Screen Layouts](#)
- [Dual Screen Layouts](#)
- [Enabling Dual Monitor Mode](#)

Single Screen Layouts

The following introduces the default layout when you connect one display screen.

Only Video Calls

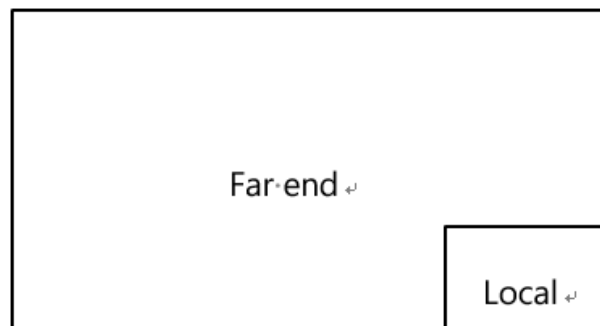

Video Calls with a Presentation

The PC content is given prominence in the largest pane and other participants are displayed beside the PC content.

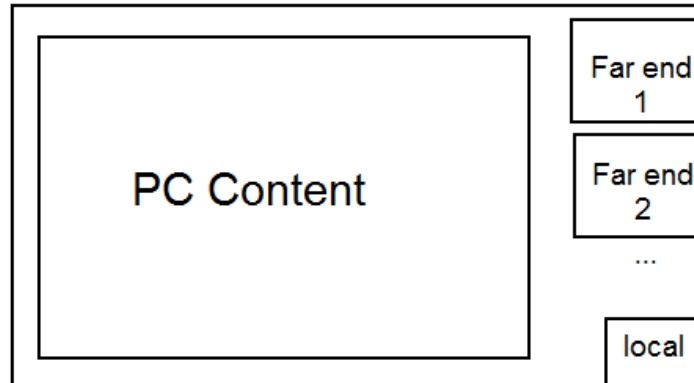

 **Tip:** Tap **Layout** to display the shared content in full screen.

Dual Screen Layouts

The following introduces the default layout when you connect two displays.

One external display displays the remote video feeds and the other display will be reserved for content sharing.

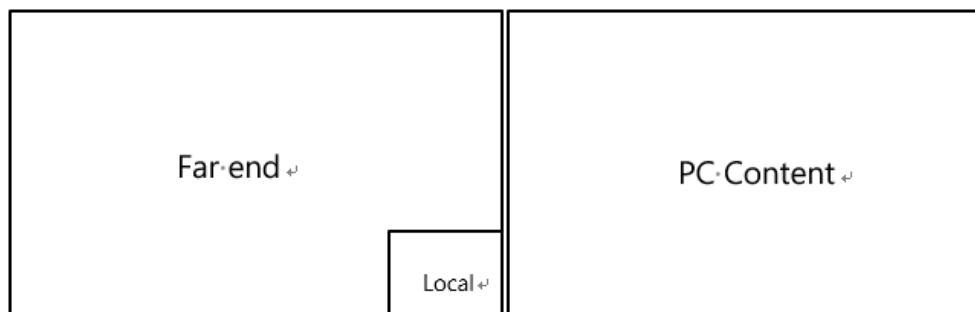

Related tasks

[Enabling Dual Monitor Mode](#)

Enabling Dual Monitor Mode

Before using two external display devices, you should enable dual monitor mode first.

Procedure

1. Navigate to **More > Settings**.

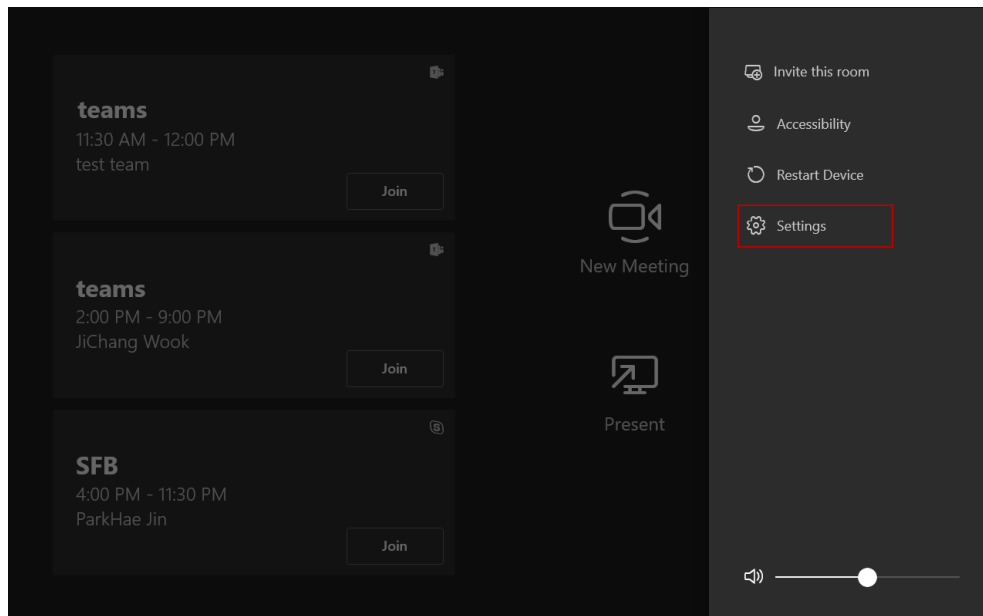

2. Enter the administrator password (default: sfb) to access the **Setup** screen.
3. In the **Device** page, enable **Dual Monitor Mode**.

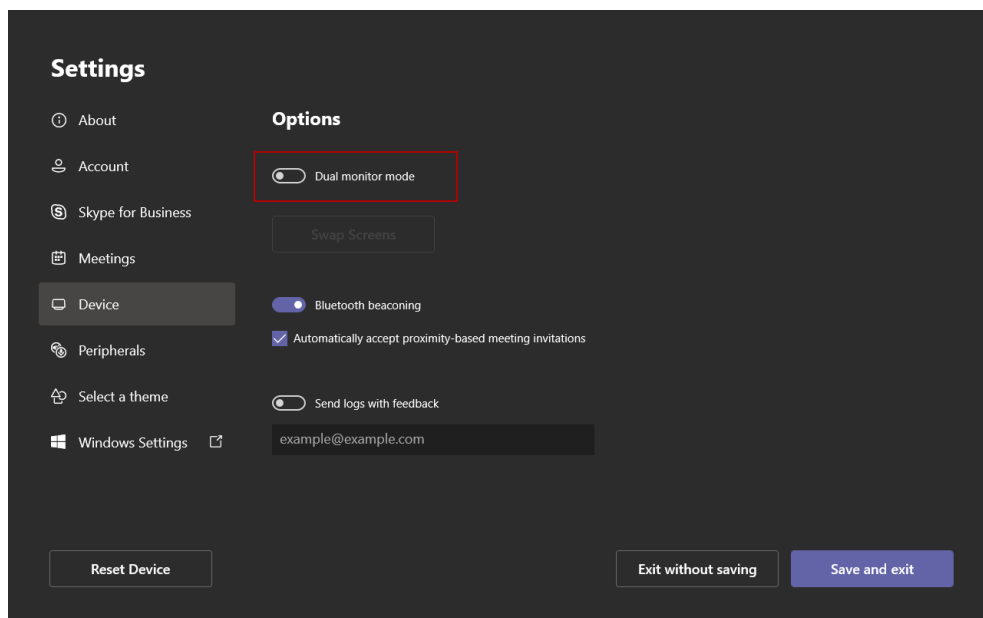

4. Tap **Save and exit**.

Content Sharing

After the MTouch II and PC are connected, you can present the content while the device is idle or during a meeting.

- [Wired Content Sharing](#)
- [Wireless Content Sharing](#)

Wired Content Sharing

After the MTouch II is connected to the PC with USB-C/HDMI, you can use MTouch II for wired content sharing.

Procedure

Do one of the following:

- From the idle screen, tap **Present** to start content sharing.
- During a meeting, tap **Present** to start content sharing with the participants.

Wireless Content Sharing

You can use Yealink WPP20 wireless presentation pod for wireless content sharing. Before content sharing, you should pair the WPP20 with the MTouch II and then connect it to the computer.



Note: Only the duplicate display mode is applicable to wireless content sharing and the extended display mode is not applicable when using multiple displays.



Note: For Mac OS, you need to use USB-A to USB-C adapter to connect WPP20.

- [Pairing the WPP20 with the MTouch II](#)
- [Sharing Content via WPP20](#)
- [Stopping Sharing Content via WPP20](#)

Pairing the WPP20 with the MTouch II

Procedure

1. Connect the WPP20 to the USB port of the MTouch II.
2. Wait for about 3 seconds, and the WPP20 LED indicator glows green.

The WPP20 is paired with the MTouch II successfully.

Sharing Content via WPP20

Before you begin

Make sure the WPP20 has been paired with the MShare.

Procedure

1. Connect the WPP20 wireless presentation pod to your computer.
2. If the WPP20 is first connected to the computer, you need to manually start the Yealink Wireless Presentation Pod software from **This PC** in Windows 10 or from **My Computer** in Windows 7 and then upgrade the WPP20.
 - After starting the software, if it prompts that the firmware version is different from the host version, you need to upgrade the WPP20 according to the prompts.
 - For the WPP20 running old versions, after starting the software, you need to manually upgrade the firmware on the software at the path  -> **Version Update**.

After the upgrade is successful, the WPP20 is ready for content sharing.
3. Do one of the following:
 - On the WPP20, press the presentation button to share the full screen.
 - On the WPP20, long press the presentation button for 3 seconds and then release this button. Select the file or the window you want to share and then click **Start Sharing**.

- On the Yealink Wireless Presentation Pod software, click **Contents Share** and choose the file you want to share, and then click **Start Sharing**.

The content you want to share is automatically projected to the display device.

 **Tip:** Go to [Yealink website](#) for the latest version of the firmware.

Related tasks

[Pairing the WPP20 with the MShare](#)

Stopping Sharing Content via WPP20

Procedure

Do one of the following:



- On your computer, remove the WPP20.
- On the WPP20, press the presentation button.
- On the Yealink Wireless Presentation Pod software, click **Stop Sharing**.

 **Tip:**

- You can tap **Stop Present** to stop sharing content when the device is idle.
- During a meeting, tap **Stop Presenting** to stop sharing content with the participants.

Adjusting the MTouch II Lightness

Procedure

1. Tap  on the idle screen.
2. Tap  and then drag the slider to adjust the lightness of the MTouch II.

Changing Sign-in Account

Procedure

1. Navigate to **More > Settings**.

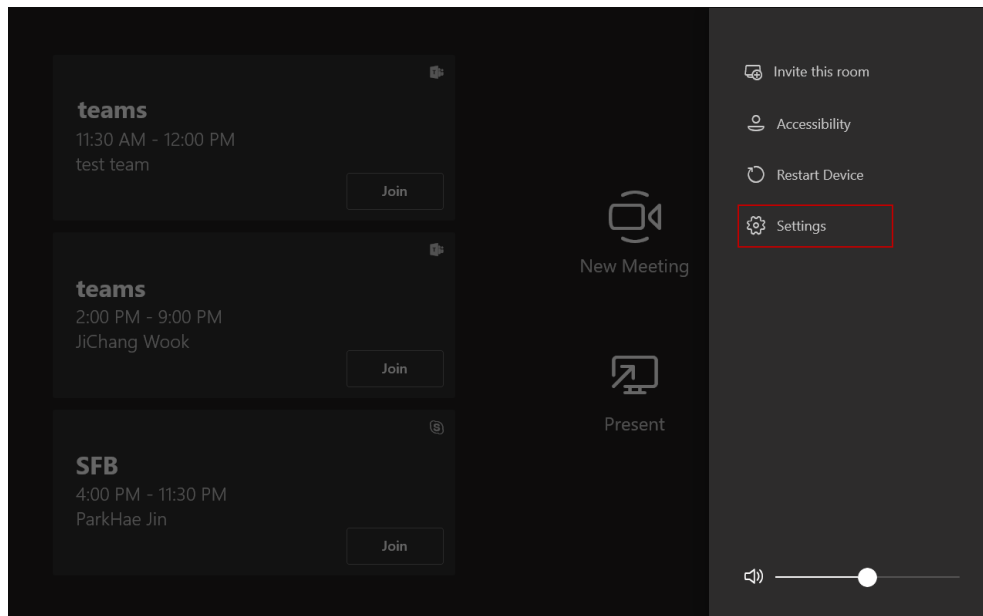

2. Enter the administrator password (default: sfb) to access the **Setup** page.
3. In the **Account** page, enter the account information in the corresponding field.
4. Tap **Save and exit**.
The new account will sign in automatically.

Basic Features for Microsoft Teams Rooms App

After you set up your device, the touch screen console is displayed on the screen. The touch screen console is the heart of every meeting in the meeting room.

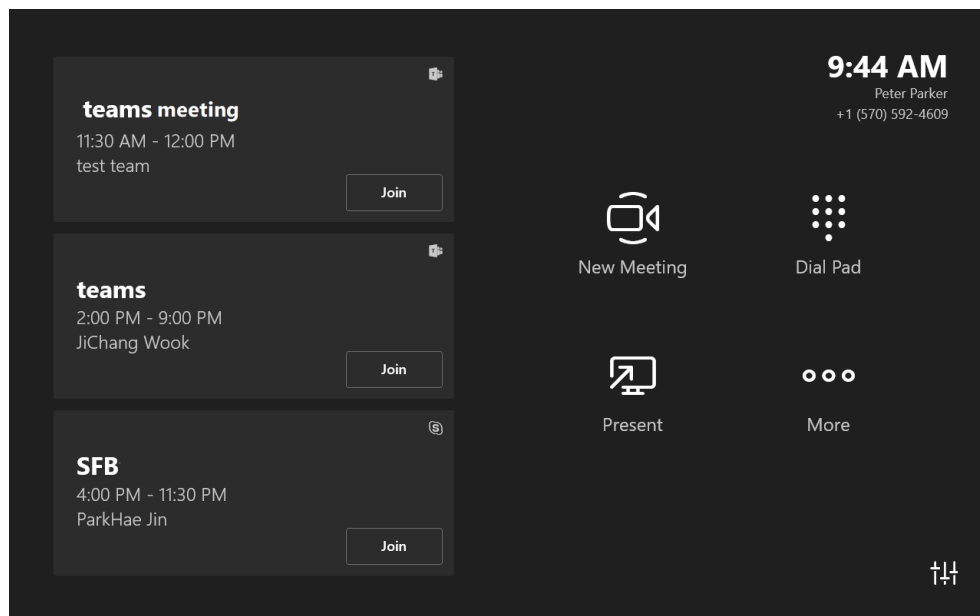

On the screen, you can do the following:

- Join a scheduled meeting by selecting the meeting.



Note: To get a meeting to show up on the room console, organizers should set the room as the meeting location.

- Start a new meeting by selecting **Meet now**.
- Make a phone call by selecting **Dial pad** and dialing a number.
- Project your laptop by plugging in the cable connected to the console. Depending on the room settings, it may be projected to the room automatically, or you may have to select **Present** on the room console.
- Select **More** for instructions on how to add the room to a meeting, give feedback on the device, or change settings.



For more information on how to use the specific features, please refer to [Microsoft Teams Rooms Help](#).

Switching Between Skype User Account And Administrator Account

- [Skype User Account Sign-in](#)
- [Administrator Sign-in](#)

Skype User Account Sign-in

Procedure

1. Tap the  button, and then go to  > **Skype**.
2. Select **Skype** from the bottom-left corner.
3. Tap **Sign in**.

Administrator Sign-in

You can sign in as an administrator, and the administrator account provides the system administration capabilities to manage the device.

Procedure

1. Navigate to **More > Settings**.

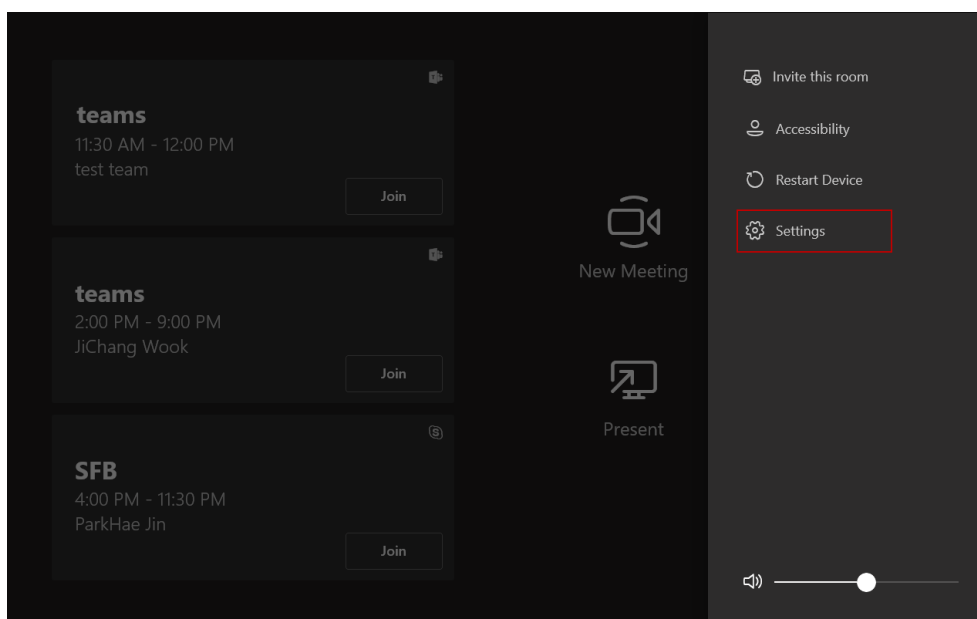

2. Enter the administrator password (default: sfb) to access the **Setup** screen.
3. Navigate to **Windows Settings**.
4. Select **Administrator** from the bottom-left corner.
5. Enter the administrator password (default: sfb) and then sign in.

Logging into Yealink Management Cloud Service/Yealink Device Management Platform

The Yealink RoomConnect plugin running under Windows automatically detect all devices in the MVC II system. After logging to the Yealink Management Cloud Service or Yealink Device Management Platform via Yealink RoomConnect, you can manage all devices in the MVC II system, including the unified upgrade, as well as diagnosis and alarm.

About this task



Note: For more information on how to manage the devices on Yealink Management Cloud Service/ Yealink Device Management Platform, please refer to [Yealink Management Cloud Service for Enterprise Administrator Guide](#)/[Yealink Device Management Platform Administrator Guide](#).

Procedure

1. Sign in your system as an administrator.
2. Run the **Yealink RoomConnect** plugin.
3. Tap  on the home page.
4. Select a desired platform to connect.
5. Depend on your choice:
 - If you select **Yealink Management Cloud Service**, enter the enterprise ID.
The enterprise ID can be obtained from the **Account Settings** on your Yealink Management Cloud Service.
 - If you select **Yealink Device Management Platform**, enter the server address.

6. Enter your meeting room.
7. Select the desired device model.
8. Tap **Confirm**.
The system will connect to the Yealink Management Cloud Service/Yealink Device Management Platform.

Related tasks

[Administrator Sign-in](#)

Troubleshooting

This section describes solutions to common issues that may occur while using the Yealink MVC900 II/MVC800 II/MVC500 II/MVC300 II. Upon encountering a case not listed in this section, contact your Yealink reseller for further support.

- [Upgrading System Software](#)
- [Firmware for Each Device](#)
- [General Issues](#)
- [Restarting the Device](#)
- [Checking the Status of Your Device](#)

Upgrading System Software

Windows Update is a service provided by Microsoft which provides security updates and functionality updates to Windows operating systems and its installed components. The system software (including Windows, the Camera-Hub/UVC80/UVC50/UVC30 Room, and the MVC300 II) can be automatically upgraded via windows update by default. Otherwise, you should enable automatically windows update or upgrade the devices manually.



Note: You can also upgrade the devices on the Yealink RoomConnect plug-in under Windows or on the Yealink Management Cloud Service/Yealink Device Management Platform.

For more information on how to upgrade the devices on the Yealink RoomConnect plug-in, please refer to [Yealink RoomConnect Userguide](#).

For more information on how to upgrade the devices on Yealink Management Cloud Service/Yealink Device Management Platform, please refer to [Yealink Management Cloud Service for Enterprise Administrator Guide](#)/[Yealink Device Management Platform Administrator Guide](#).

- [Enabling Automatically Windows Update](#)
- [Manually Windows Update](#)

Enabling Automatically Windows Update

Procedure

1. Navigate to **More > Settings**.

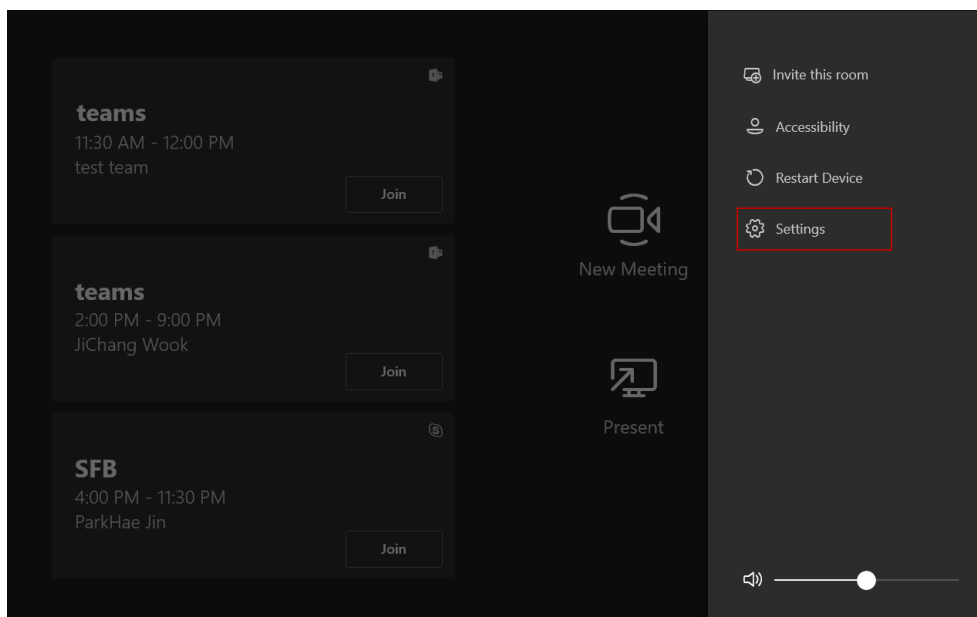



2. Enter the administrator password (default: sfb) to access the **Setup** screen.
3. Navigate to **Windows Settings**.
4. Select **Administrator** from the bottom-left corner.
5. Enter the administrator password (default: sfb) and then sign in.
6. Tap the  button, and then go to **Settings > Upgrade & Security > Windows Update**, and select **Advanced options**.
7. Enable **Automatically download updates, even over metered data connections(charge may apply)**.

Manually Windows Update

Procedure

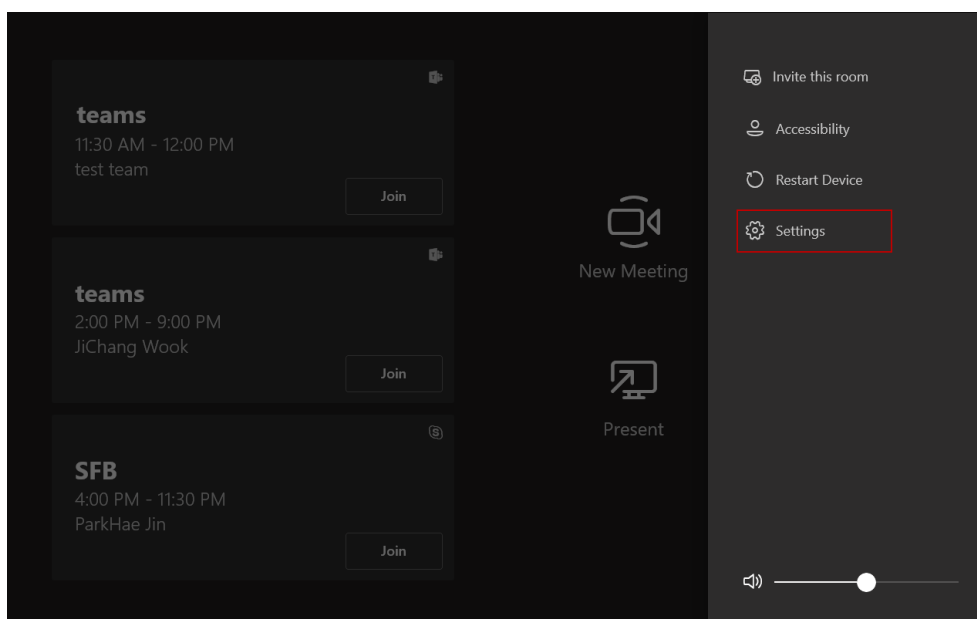
1. Navigate to **More > Settings**.



2. Enter the administrator password (default: sfb) to access the **Setup** screen.
3. Navigate to **Windows Settings**.
4. Select **Administrator** from the bottom-left corner and then enter the administrator password.
5. Do one of the following:
 - Long tap the  button and then select **Device Manager**.
Select the desired device and then long tap the device to select **Update driver**.
Select the desired way to update.
 - Tap the  button, and then go to **Settings > Upgrade & Security > Windows Update**, and select **Check for updates**.
Select the desired device and then complete the installation.

Firmware for Each Device

The firmware versions of the devices in the MVC II system need to match each other.

The following table lists the associated and latest firmware name for each device:

Device Model	Firmware Name
Camera-Hub	84.421.0.5.rom or later
UVC30	105.420.0.10.rom or later
UVC80/UVC50	92.421.0.5.rom or later
Yealink Plug-in Software(Yealink RoomConnect)	2.1.17.0 or later
MTouch II	126.410.0.5.rom or later

The information mentioned in this document is applicable to Microsoft Teams APP in version 4.3.42.0 or later,

General Issues

- [Does the MVC900 II/MVC800 II/MVC500 II/MVC300 II Come with All the Necessary Software Pre-installed?](#)
- [The Room Is Not Enabled for Teams Meetings](#)
- [There Is No Content Displayed on the Second Display](#)
- [Any Anti-virus Software Needed to Be Installed on the MCore?](#)

Does the MVC900 II/MVC800 II/MVC500 II/MVC300 II Come with All the Necessary Software Pre-installed?

The MVC900 II/MVC800 II/MVC500 II/MVC300 II comes with factory imaged Windows 10 IoT and installed with all the necessary software. The only customer requirements are Teams, Skype for Business or Lync credentials to run on the MVC II system. For more information, refer to [Microsoft Teams Rooms](#) .

The Room Is Not Enabled for Teams Meetings

You should enable Teams meeting mode on your system before using the Teams meetings.

Procedure

1. Navigate to **More > Settings**.

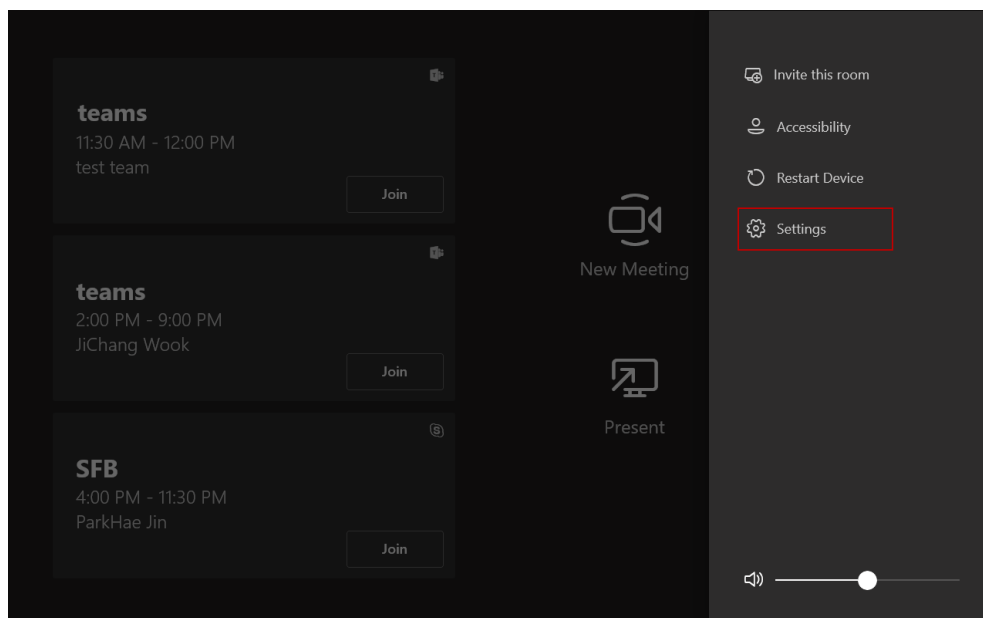

2. Enter the administrator password (default: sfb) to access the **Setup** screen.
3. In the **Account** page, select **Skype for Business (default) and Microsoft Teams** or **Skype for Business and Microsoft Teams (default)** from the **Supported meeting mode** field.
4. Tap **Save and exit**.

The configuration takes effect after the system restarts.

There Is No Content Displayed on the Second Display

Do one of the following:

- Ensure both displays are properly connected to the HDMI ports on the back of the MCore.
- Ensure the **Dual Monitor** mode is enabled on the **Device** settings page.
- Restart the device if necessary.

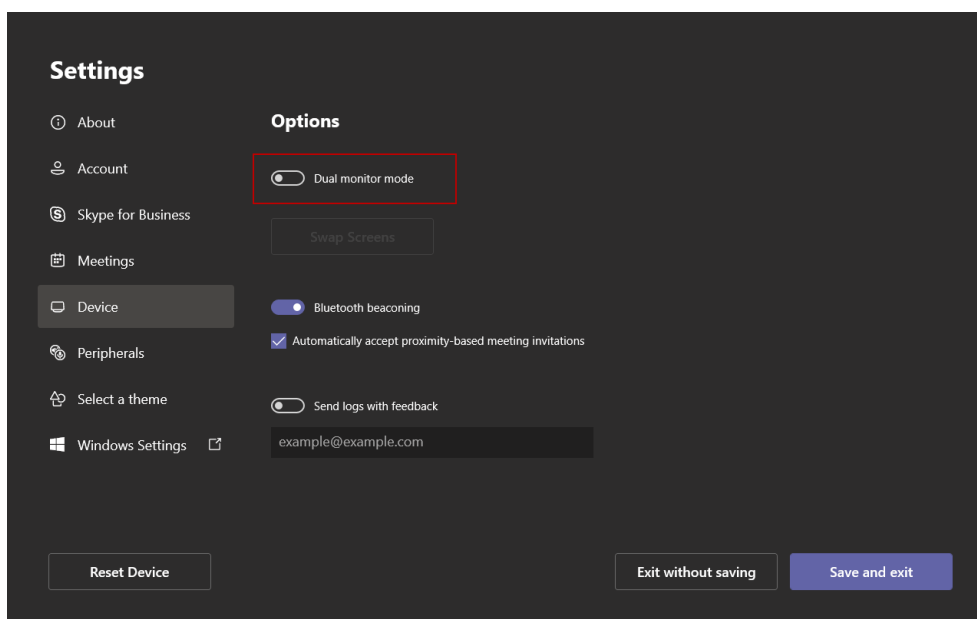

Related tasks

[Enabling Dual Monitor Mode](#)

Any Anti-virus Software Needed to Be Installed on the MCore?

Microsoft itself has Windows Defender, a legitimate antivirus protection plan already built into Windows 10. But not all antivirus software is the same, and you can choose antivirus software based on its ability to defend against threats.

Restarting the Device

After you restart the device, it will automatically launch the Teams Room Systems app and sign in the account.

Procedure

Navigate to **More > Restart Device**.

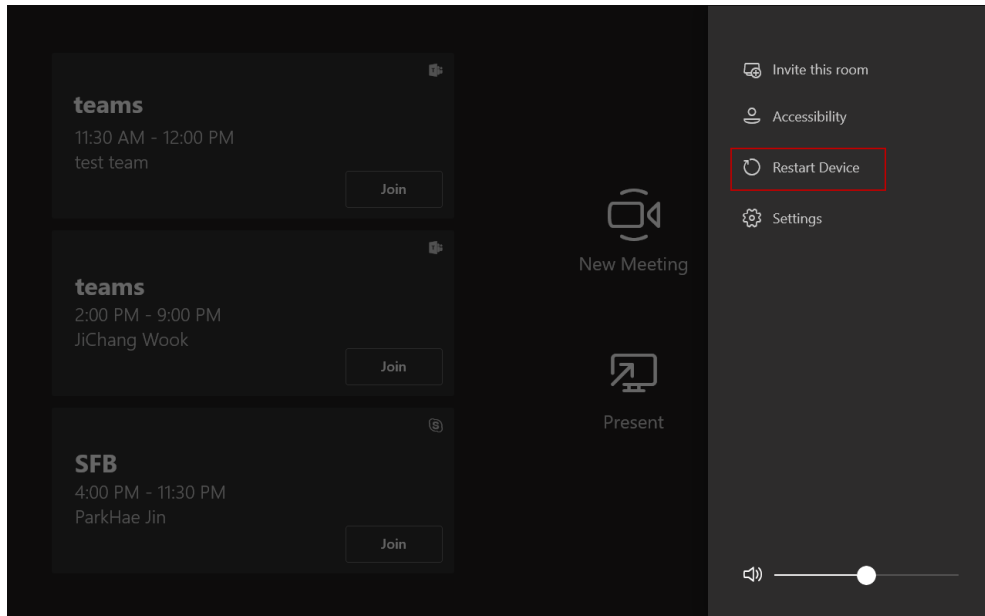

Checking the Status of Your Device

You can view the firmware and hardware of the connected devices (Camera-Hub/UVC80/UVC50/UVC30 Room, MTouch II and VCM34) on your system.

Procedure

Tap  to enter the **Status** page.

Appendix

Get more about the end-to-end approach to planning, delivering, operating Microsoft Teams Rooms, the deployment of Microsoft Teams Rooms and how to configure a Microsoft Teams Rooms console, see the following links:

- For more information on how to plan Microsoft Teams Rooms, please visit [Plan Microsoft Teams Rooms](#).
- For more information on the deployment of Microsoft Teams Rooms, please visit [Deployment Overview](#).
- For more information on how to configure a Microsoft Teams Rooms console, please visit [Configure a Microsoft Teams Rooms Console](#).