



Quadro

The IP PBXs



Manual I: **Installation Guide**

for Quadro4Li; SW-Version 5.2.x

Copyright and Trademarks

Copyright © 2003-2011 Epygi Technologies, Ltd. All Rights Reserved. Quadro is a registered trademark of Epygi Technologies, Ltd. Microsoft, Windows, and the Windows logo are registered trademarks of Microsoft Corporation. All other trademarks and brand names are the property of their respective proprietors.

Limited Warranty

Epygi Technologies, Ltd. ("Epygi") warrants to the original end-user purchaser every Quadro to be free from physical defects in material and workmanship under normal use for a period of one (1) year from the date of purchase (proof of purchase required) or two (2) years from the date of purchase (proof of purchase required) for products purchased in the European Union (EU). If Epygi receives notice of such defects, Epygi will, at its discretion, either repair or replace products that prove to be defective.

This warranty shall not apply to defects caused by (i) failure to follow Epygi's installation, operation or maintenance instructions; (ii) external power sources such as a power line, telephone line, or connected equipment; (iii) products that have been serviced or modified by a party other than Epygi or an authorized Epygi service center; (iv) products that have had their original manufacturer's serial numbers altered, defaced, or deleted; (v) damage due to lightning, fire, flood, or other acts of God.

In no event shall Epygi's liability exceed the price paid for the product from direct, indirect, special, incidental, or consequential damages resulting from the use of the product, its accompanying software, or its documentation. Epygi offers no refunds for its products. Epygi makes no warranty or representation, expressed, implied, or statutory, with respect to its products or the contents or use of this documentation and all accompanying software, and specifically disclaims its quality, performance, merchantability, or fitness for any particular purpose.

Return Policy

If the product proves to be defective during this warranty period, call Epygi Customer Support at (972) 692-1166 to obtain a Return Material Authorization (RMA) Number. Registered users also may access Epygi's Technical Support (www.epygi.com; 'Support') to send their RMA request. For Brazil representatives, call (21) 2518-3161 or contact via Web (www.saga.com.br). Please have your proof of purchase on hand when contacting us. When returning a product, mark the Return Authorization Number clearly on the outside of the package and include your original proof of purchase. Return requests cannot be processed without proof of purchase. Customers are responsible for shipping and handling charges when shipping to Epygi.

Epygi or its service center will use commercially reasonable efforts to ship a replacement product within ten (10) working days after receipt of the returned product. Actual delivery times may vary depending on customer location.

Epygi reserves the right to revise or update its products, pricing, software, or documentation without obligation to notify any individual or entity. Please direct all inquiries to:

Epygi Technologies, Ltd., Two Legacy Town Center, 6900 North Dallas Parkway, Suite 850, Plano, Texas 75024

Representative in Brazil - Saga Sistemas e Computadores SA, Av. Rio Branco, 18 - 8 andar, Rio de Janeiro 20090-001

Notice to Users

This Installation Guide, in whole or in part, may not be reproduced, translated, or reduced to any machine-readable form without prior written approval.

Epygi provides no warranty with regard to this Installation Guide or other information contained herein and hereby expressly disclaims any implied warranties of merchantability or fitness for any particular purpose in regard to this manual or other such information. In no event shall Epygi be liable for any incidental, consequential, or special damages, whether based on tort, contract, or otherwise, arising out of or in connection with this manual or other information contained herein or the use thereof.

FCC Statement (Part 15) Class A

- The Epygi Quadro4Li has been tested and found to comply with the limits for a class A digital device, pursuant to Part 15 of the FCC Rules. These limits are designed to provide reasonable protection against harmful interference in a commercial installation. This equipment generates, uses, and can radiate radio frequency energy and, if not installed and used in accordance with the instructions, may cause harmful interference to radio communications. However, there is no guarantee that interference will not occur in a particular installation. If this equipment does cause harmful interference to radio or television reception, which is found by turning the equipment off and on, the user is encouraged to try to correct the interference by one or more of the aforementioned measures.

You are cautioned that any change or modification to the equipment not expressly approved by the manufacturer could void the user's authority to operate this device.

Administrative Council for Terminal Attachments (ACTA) Customer Information

This equipment complies with Part 68 of the FCC rules and the requirements adopted by the ACTA. On the back of this equipment is a label that contains, among other information, a product identifier in the format US:AAAEQ###TXXXX, made out to HX7OT00BHX70100. If requested, this number must be provided to the telephone company.

Any plug or jack that is used to connect this equipment to the premises wiring and telephone network must comply with the applicable FCC Part 68 rules and requirements adopted by the ATCA.

The Ringer Equivalence Number is an indicator of the maximum number of devices allowed for connection to a telephone interface. The termination on an interface may consist of any combination of devices subject only to the requirements that the sum of the RENs of all the devices does not exceed five. Excessive RENs on a telephone line may result in the devices not ringing in response to an incoming line. The REN for this product is part of the product identifier that has the format US:AAAEQ###TXXXX, made out to HX7OT00BHX70100. The digits represented by ### are the REN without a decimal point (in this case 00B is a REN of 0.0B.)

If the Quadro causes harm to the telephone network, the telephone company will notify you in advance that a temporary discontinuance of service may be required. But if advance notice isn't practical, the telephone company will notify the customer as soon as possible. Also, you will be advised of your right to file a complaint with the FCC if you believe it is necessary.

The telephone company may make changes in its facilities, equipment, operations or procedures that could affect the op-

eration of the equipment. If this happens, the telephone company will provide advance notice for you to make the necessary modifications to maintain uninterrupted service.

Connection to a party line service is subject to state tariffs. Contact the state public utility commission, public service commission or the corporation commission for information.

If your home has specially wired alarm equipment connected to the telephone line, ensure the installation of the Quadro does not disable your alarm equipment. If you have any questions about what will disable alarm equipment, consult your telephone company or a qualified installer.

Electrical Safety Advisory

To reduce the risk of damaging power surges, we recommend you install an AC surge arrester in the AC outlet from which the Quadro is powered.

Industry Canada Statement

This product meets the applicable Industry Canada technical specifications.

Safety Information

Before using the Quadro, please review and ensure the following safety instructions are adhered to:

- To prevent fire or shock hazard, do not expose your Quadro to rain or moisture.
- To avoid electrical shock, do not open the Quadro. Refer servicing to qualified personnel only.
- Never install wiring during a lightning storm.
- Never install telephone jacks in wet locations unless the jack is specified for wet locations.
- Never touch uninsulated telephone wire or terminals unless the telephone line has been disconnected at the network interface.
- Use caution when installing or modifying cable or telephone lines.
- Avoid using your Quadro during an electrical storm.
- Do not use your Quadro or telephone to report a gas leak in the vicinity of the leak.
- An electrical outlet should be as close as possible to the unit and easily accessible.

Emergency Services

The Quadro SIP Service is intended to function as a secondary telephone service. This service is made available through the Internet and therefore is dependent upon a constant source of electricity and network availability. If a power outage occurs, the Quadro SIP Service automatically will be disabled. User understands in the event of a power or network outage, the Quadro SIP Service will not support 911 emergency services, and further, such services only will be available via the user's regular telephone line that is not connected to the Quadro. User further acknowledges that any interruption in the supply or delivery of electricity or network availability is beyond Epygi's control and Epygi shall have no responsibility for losses arising from such interruption.

Table of Contents

Manual I: Installation Guide

About This Installation Guide	6
Requirements.....	7
Hardware Overview.....	8
The Connectors Panel of Quadro4Li.....	8
Quadro4Li's Front Panel LEDs.....	9
Step 1: Installing the Quadro	10
Networking Overview.....	10
LAN/WAN Connection Options	11
Connecting the Hardware	13
Step 2: Configuring the Quadro	15
Step 2.1: Logging into Quadro	15
Step 2.2: System Configuration Wizard.....	16
System Configuration	16
DHCP Settings for the LAN Interface	17
Regional Settings.....	17
Emergency and PSTN Access Code Settings	18
Finishing the System Configuration Wizard	19
Step 2.3: Internet Configuration Wizard.....	21
Uplink Configuration.....	22
WAN IP Configuration	23
PPP/PPTP Configuration.....	24
WAN Interface Configuration	25
DNS Settings	25
Finishing the Internet Configuration Wizard.....	26
Step 2.4: Configuring the ISDN Settings	27
Run the ISDN Wizard.....	27
Step 2-A: Using IP Lines	32
Supported SIP Phones.....	35
Tested SIP phones.....	36
Step 2-B: Using Key System Emulation.....	36
Using SLA Lines for SIP Calls	37
Disabling the Key System Emulation	39
Step 2-C: Using Receptionist	39
Step 3: Registering on Epygi's Technical Support.....	40
Step 4: Making/Receiving Calls	41
Using the Default SIP Addresses.....	41
Appendix: Changing the Admin Password	43
Appendix: Configuring NAT Traversal.....	45
Appendix: Registering on Epygi's SIP Server.....	47

Appendix: Checking the Connections 51
Appendix: Pin Assignment of ISDN 53

Manual II: see Administrator's Guide

This guide describes in detail the menus available for administrators only. Furthermore, it includes all the system's default values at a glance.

Manual III: see Extension User's Guide

This guide describes in detail the menus available for extension users. Furthermore, it includes all the call codes at a glance.

About This Installation Guide

This Installation Guide explains the installation of the Quadro IP PBXs of Quadro4Li series. Quadro4Li offers 4 phone lines (ISDN), 1 Ethernet LAN port and 1 Ethernet WAN port as external interfaces.

This Installation Guide gives step-by-step instructions to provision the Quadro and configure the phone extensions with the Epygi SIP Server. After successfully configuring the Quadro, a user will be able to make SIP phone calls to remote Quadro devices, make local calls to the PSTN and access the Internet from devices connected to the LAN.

This Installation Guide neither describes the PBX, Auto Attendant, Call Relay, and Voice Mail features of the Quadro nor does it provide advanced firewall and VPN configuration information. For these features, refer to the Administrator's and Extension User's Guides.

[Step 1: Installing the Quadro](#) explains the connection of cables and devices to the Quadro.

[Step 2: Configuring the Quadro](#) describes the configuration steps necessary to integrate the Quadro into your network environment.

[Step 2-A: Using IP Lines](#) explains how to configure IP lines on the Quadro IP PBX.

[Step 2-B: Using Receptionist](#) refers to the document describing Receptionist's configuration on the Quadro.

[Step 3: Registering on Epygi's Technical Support](#) shows you how to access the Epygi Technical Support Center and the Epygi SIP Server.

[Step 4: Making/Receiving Calls](#) explains how to enable the Quadro's various telephony features.

[Appendix: Changing the Admin Password](#) explains how to change the default administrator password.

[Appendix: Configuring NAT Traversal](#) explains configuration of the Quadro if it is placed behind a NAT enabled router.

[Appendix: Registering on Epygi's SIP Server](#) explains how to register on Epygi's powerful SIP server.

[Appendix: Checking the Connections](#) gives hints on solving common problems.

Requirements

- One 120/240 V power outlet in close proximity to the Quadro4Li.
- One RJ-45 Ethernet 10/100 broadband Internet connection, if Quadro4Li shall be used as a standalone gateway
- One CAT 5 Ethernet cable with an RJ-45 connector to connect to the Quadro4Li LAN port
- One PC with a 10Mbps or a 10/100 Mbit/s Ethernet card or adapter installed.
- TCP/IP network protocol installed on each PC.
- For optimal results, Internet Explorer 5.5 or higher, or Netscape Navigator 4.7 or higher are recommended.)

Please Note: The Quadro4Li is shipped with one straight RJ-45 CAT 5 cable. If the LAN connector of the Quadro4Li is to be connected to a hub or switch, a crossover cable may be required (see [Appendix: Pin Assignment of ISDN](#), too).

Hardware Overview

The Connectors Panel of Quadro4Li

The illustration below includes the connectors panel of Quadro4Li model.

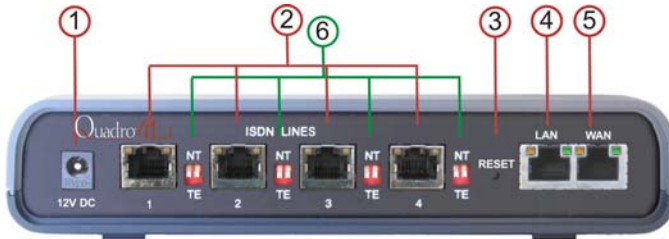

Fig. I- 1: Connectors Panels of Quadro4Li IP PBX

- 1 Power supply socket. **Use only the power adapter delivered with the Quadro.**
- 2 ISDN sockets to connect the Quadro to the ISDN network termination units to use PSTN services. A straight Ethernet CAT 5 cable can be used with an RJ45 connector according to the ISDN Pin assignment, see [Appendix: Pin Assignment of ISDN](#).
- 3 The Reset button may be used in two ways: (1) to initiate a normal reset or (2) to carry out a factory reset. A normal reset is executed by pressing the **Reset** button with a paper clip for an instant.

Pressing the reset button and holding it down for seven seconds or more will execute a factory reset. This will restore the factory defaults and clear all settings including the IP address and the administration password you entered.

Please Note: A Factory Reset forces the default LAN IP address of 172.30.0.1 and default admin password of 19.

- 4 RJ45 socket to attach to the Local Area Network (LAN) via an Ethernet CAT 5 cable. If a PC is connected directly to this socket, a straight cable is used. If an Ethernet hub, router or switch is used; a crossover cable may be required. This port may also be used to connect IP phones to the Quadro (optional). In this case, it is recommended to use a hub or a switch to connect the PC along with IP phones to the Quadro's LAN port.
- 5 RJ45 socket to attach the Internet Uplink (WAN) via an Ethernet CAT 5 cable. This port may also be used to connect IP phones to the Quadro. The default configuration settings assume that IP phones are attached to this, rather than the LAN port.
- 6 The NT/TE switches are used to control the Quadro4Li device on the S/T Bus. If the Quadro4Li is connected to the beginning or end of the S/T Bus or if there is only one ISDN unit connected to the S/T Bus, then this switch should be toggled to the NT (Network Terminator) position. Otherwise, if the Quadro4Li is connected in the middle of the S/T Bus, the switch should be toggled to the TE (Terminal Endpoint) position.

S/T Bus is a full-duplex interface. It consists of two groups (one for transmit and the other one for receive) of two-wire interface and might support multiple devices (up to 8 devices can be attached to the S/T Bus). Both ends of each of the two-wire interfaces should be terminated (100ohm resistance is present at both ends of each two-wire interface).

Please Note: If the trunks on the Quadro4Li have incorrect NT/TE position, they may not function properly, including connection establishment permanent failure.

Quadro4Li's Front Panel LEDs

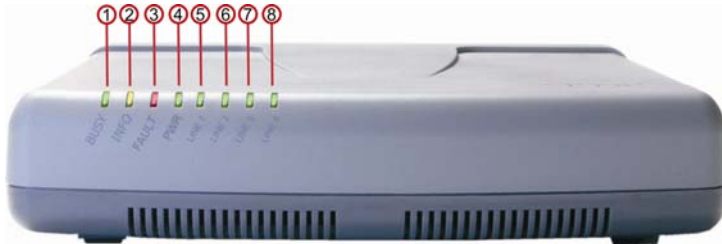

Fig. I-1: Quadro4Li's Front Panel LEDs

1	Busy green Status of CPU	off: no power on or blinking: normal activity
2	Info yellow System information	on: device is booting off: no information blinking: an event occurred; details specified in the System Event section of the Management interface
3	Fault red System status	on either an error or the device is booting off: no error blinking: system unusable
4	PWR green Status of the power supply	on: power supply ok off: no power supply or device is still booting
5	Line 1 green Status of the ISDN1 line	on: all channels on the Line 1 are busy off: no call in progress or one active call flickering: ISDN Line 1 is disconnected
6	Line 2 green Status of the ISDN2 line	on: all channels on the Line 2 are busy off: no call in progress or one active call flickering: ISDN Line 2 is disconnected
7	Line 3 green Status of the ISDN3 line	on: all channels on the Line 3 are busy off: no call in progress or one active call flickering: ISDN Line 3 is disconnected
8	Line 4 green Status of the ISDN4 line	on: all channels on the Line 4 are busy off: no call in progress or one active call flickering: ISDN Line 4 is disconnected

LED Indication during a firmware update

A firmware update is indicated by the red (**Fault**) and yellow (**Info**) LEDs. Both will blink simultaneously for about two minutes while the firmware is being updated. The Quadro4Li will then reboot automatically showing the boot LED sequence.

LED indication during a boot sequence

A boot sequence is indicated as follows: The red **Fault** LED will glow for a few seconds, then the yellow **Info** LED will glow for another four or five minutes while the green **Busy** LED is blinking. Once the **Info** LED is off, the boot sequence has been completed successfully.

LED indication during emergency firmware upload

The red **Fault** LED and the yellow **Busy** LEDs will stop blinking alternately and start blinking in parallel. This shows that Quadro has accepted the emergency firmware and is loading it. After a few seconds, Quadro will boot, indicated as follows: The red **Fault** LED will glow for a few seconds, then the yellow **Info** LED will glow for another few seconds while the green **Busy** LED is jittering. When the yellow **Info** LED extinguishes, the boot sequence has been completed successfully.

Step 1: Installing the Quadro

Networking Overview

To establish a connection between the Internet and your local area network (LAN), an access router is needed. The Quadro4Li may serve, among other functions, as an access router, and will perform the task of connecting your LAN, or a group of one or more PCs, to the wide area network (WAN) or the Internet. The Quadro will process and regulate the data traffic between these two networks. The Quadro4Li has one LAN port that can connect to Ethernet hubs and switches on the LAN, allowing additional devices to be connected to the network.

The Quadro is a device with two sides: one side connects to your LAN, and the other side connects to the Internet, or the WAN. Quadro's firewall and Network Address Translation (NAT) functionality protects your LAN from being seen from the Internet side making the LAN private and secure.

The Ethernet WAN port transmits up to 10 Mbps, and the LAN port transmits at 10 Mbps or 100 Mbps.

Every device within an IP network requires a unique IP address to identify itself. Since the Quadro connects to both the LAN and the WAN, it has to be part of both networks, and must have two IP addresses: one for the WAN side and one for the LAN side. The Quadro's integrated firewall/NAT functionality will hide the LAN IP address from the WAN (Internet) side.

There are two ways of assigning a WAN IP address: statically or dynamically.

A Static IP address is a fixed, manually assigned IP address that remains valid until changed. If you plan to use the Quadro as your Internet access router, contact your Internet Service Provider (ISP) to find out if a static IP address is assigned to your account. If so, you will need this static IP address when configuring the Quadro device.

A dynamic IP address is a temporary address that is automatically assigned by your ISP and will change periodically. If your ISP offers a dynamic IP address, the Quadro will act as a DHCP client and will receive a new IP address from the ISP's DHCP server or PPPoE feature.

Please Note: A DHCP client is a piece of software that requests an IP address from a DHCP server. A DHCP server assigns on request a unique IP address to a device. The Quadro, like many routers, acts as a DHCP client on its WAN interface and as a DHCP server on its LAN interface.

The Quadro must be visible to the Internet to be able to receive and send VoIP calls. When the Quadro is placed in a private network, typically behind existing routers, it will by default attempt to pass through the NAT of this router with its STUN (Simple Traversal of UDP over NAT) feature. STUN will work without user configuration with the majority of basic routers. In some scenarios, port forwarding on the router is required to make the Quadro accessible to other Quadro devices and the Epygi SIP Server on the Internet. Another configuration option is to use the Quadro as the Internet access router, connected directly to the WAN, eliminating the traverse to the local NAT firewall.

LAN/WAN Connection Options

- A Quadro4Li with an Ethernet WAN port behind a router, which is connected to a cable or xDSL modem. IP phones are placed on the WAN side of the Quadro4Li.

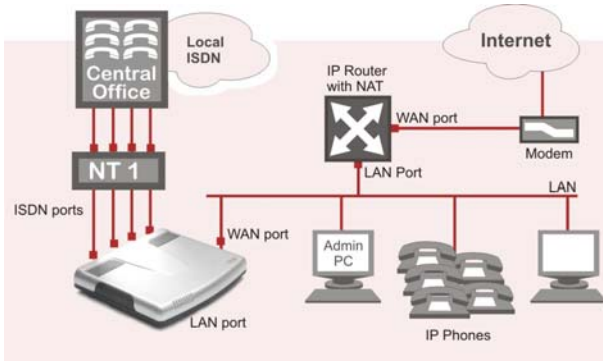

Fig. I-2: Configuration: Quadro4Li behind a router with IP phones on WAN

In this and the following configuration (Fig. I-2 and Fig. I-3), the IP router typically acts as a DHCP server for the LAN and assigns the IP addresses to the PCs and other devices. The Quadro can be connected through its WAN port directly to one of the router's LAN ports and will get an IP address from the router. By default, the Quadro acts as a DHCP client on the WAN port. The IP phones are placed on the WAN side of the Quadro4Li, connected to the company LAN.

The Admin PC can be connected to the Quadro WAN (Fig. I-2) or LAN (Fig. I-3) port to access the Web Management of the Quadro.

Please Note: Since Quadro uses STUN by default, it will work with most basic routers without any further configuration.

- A Quadro4Li with an Ethernet WAN port behind a router, which is connected to a cable or xDSL modem. IP phones are placed on the LAN side of the Quadro4Li.

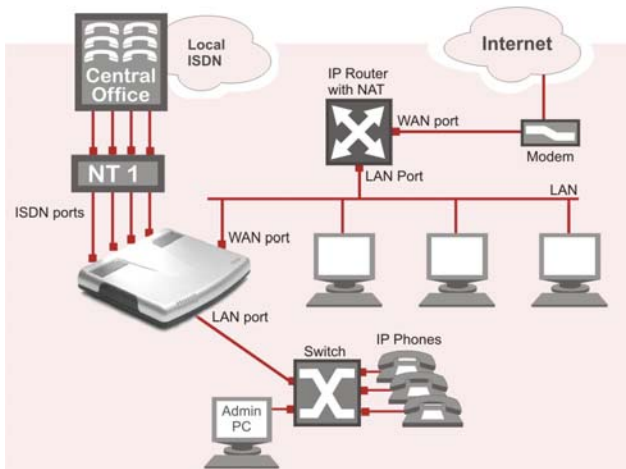

Fig. I-3: Configuration: Quadro4Li behind a router with IP phones on LAN

- **A Quadro4Li used as an Internet Access Router, connected directly to the Internet.**

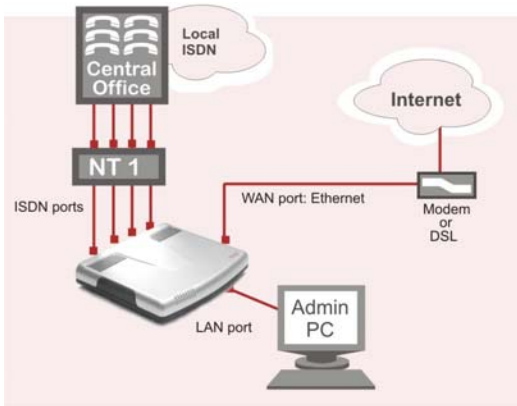

Fig. I-4: Configuration: Quadro used as Internet Access Router

Please Note: The Admin PC is connected to the Quadro's LAN port through a switch/hub to access the Web Management of the Quadro (see Fig. I-3 and Fig. I-4). It is recommended to have Admin PC acting as a DHCP client and obtaining IP address from the Quadro.

Connecting the Hardware

- **Quadro4Li behind a router with IP phones connected to WAN**

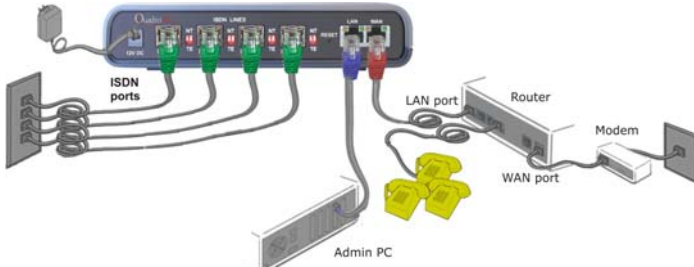

Fig. I- 5: Installation: Quadro4Li behind a router with IP phones on WAN

- **Quadro4Li behind a router with IP phones connected to LAN**

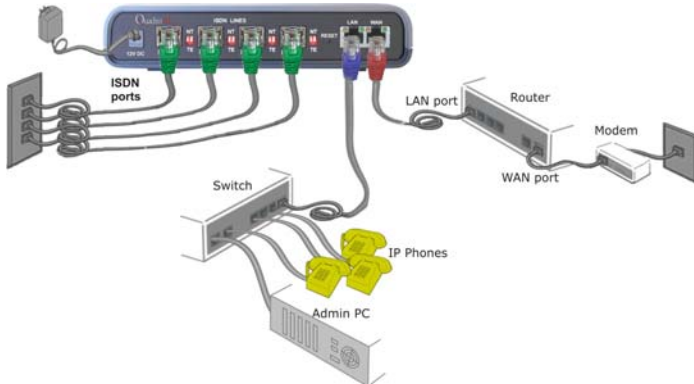

Fig. I- 6: Installation: Quadro4Li behind a router with IP phones on LAN

- **Quadro4Li used as Internet access router**

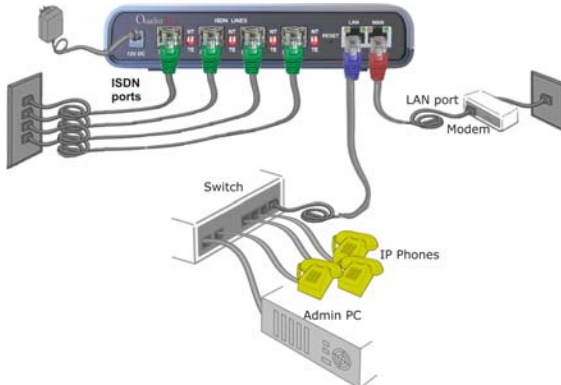

Fig. I- 7: Installation: Quadro4Li used as an Internet Access Router

- Verify the product package contents are complete. Refer to the contents sheet included in the packaging to determine if all the items were shipped in the box.
 - Before you connect the hardware, make sure that all devices are powered off.
 - Connect the Quadro4Lis LINE ports to the trunk from the NT1 (Network Termination Unit) attached to the PSTN Central Office via straight CAT 5 cable (see [Appendix: Pin Assignment of ISDN](#)).
 - Connect the Ethernet port on your PC via a straight CAT 5 cable with an RJ45 connector to the LAN or WAN socket of the Quadro. If a hub or switch is connected between the Quadro and your PC, use a crossover cable from the LAN interface of the Quadro to the hub/switch.
 - Connect at least one SIP phone to the Quadro. You will need an intermediate hub/switch. Use a crossover cable to connect the hub/switch to the Quadro's LAN or WAN socket. Plug your SIP phones to the hub/switch with a straight CAT 5 cable with an RJ45 connector. The same hub/switch can also be used to connect PCs to the Quadro.
 - Connect the WAN port of the Quadro to the Internet service via a cable or DSL modem.
 - Power up the DSL or Cable modem first.
 - Connect the power adapter to the POWER port on the Quadro's rear panel and plug the power adapter into a power outlet. Only use the original Quadro power adapter and plug it into a power strip with surge protection or to a UPS if available. The red LED (Fault) will glow for several seconds followed by the yellow LED (Info), which will glow for several minutes. When Info LED is off, the Quadro is operational.
 - Power up any hub or switch followed by any PC and other devices on the LAN side.
 - Check the LEDs: The green Busy LED must glow continuously. The green LAN and WAN LEDs will blink when cables are connected to these ports and all devices are powered up. If the green LAN and WAN LEDs do not blink, verify cabling and ensure that all devices are powered up.
- Please Note:** CAT 5 cables can be faulty without any visual indication. The LAN and WAN LEDs verify that the Ethernet connection is established between the end points. If these LEDs are not illuminated, there is a connection problem between the Quadro and the other device. Some modems, hubs, switches and routers will require the use of crossover cables.

Step 2: Configuring the Quadro

Step 2.1: Logging into Quadro

- Start a browser (MS Internet Explorer, Netscape, Opera) on a PC connected to the Quadro4Li via the LAN or WAN interface.
- In the address field, enter **http://Quadro_WAN_IP** (the IP address assigned by the company's DHCP sever) if the PC is connected to the Quadro WAN port; or **http://172.30.0.1** (Quadro's default LAN IP address) if the PC is connected to the Quadro's LAN port
- The **Login** page of the Quadro will be displayed (see Fig. I- 8).



Q4Li109

Quadro

Quadro4Li Management

Login

Login as an Administrator or Extension.

Username / Extension:

Password:

Copyright (C) 2003-2008 Epygi Technologies, Ltd. All rights reserved.

Fig. I- 8: Login page

Enter **admin** as the Username and **19** as the password to log in as the administrator. Once you log in, you will enter into the Quadro Management Menu.

Please Note: If you consecutively enter a wrong password and/or username for five times the device will be unavailable for login for five minutes.

After logging in, the **Quadro Management** page will be displayed.

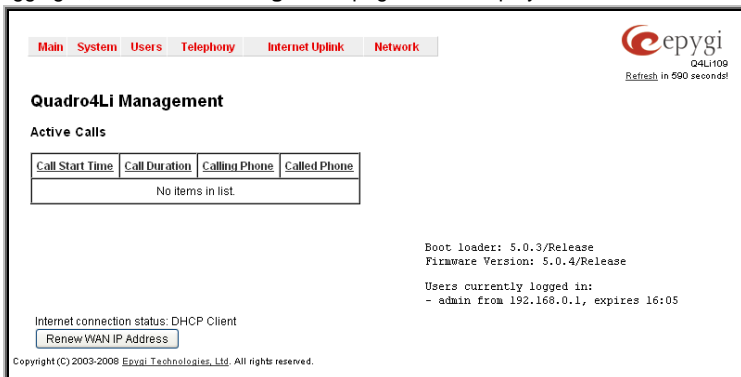

Q4Li109
Refresh in 590 seconds

Quadro4Li Management

Active Calls

Call Start Time	Call Duration	Calling Phone	Called Phone
No items in list.			

Boot loader: 5.0.3/Release
 Firmware Version: 5.0.4/Release
 Users currently logged in:
 - admin from 192.168.0.1, expires 16:05

Internet connection status: DHCP Client

Copyright (C) 2003-2008 Epygi Technologies, Ltd. All rights reserved.

Fig. I- 9: Quadro Management page

Step 2.2: System Configuration Wizard

The **System Configuration Wizard** must be run upon Quadro first startup. The **System Configuration Wizard** is a tool for the administrator to specify regional configuration settings and to define the Quadro's Local Area Network settings.

To run the wizard, select the **System Configuration Wizard** from the **System** menu.

For the basic configuration, some pages in this wizard may be skipped and left default for the basic configuration.

Please Note: It is strongly recommended that factory default settings are left unchanged if their meanings are not completely understandable to the party administrating the Quadro.

System Configuration

The first page of System Configuration Wizard shows all items to be configured. Click the **Next** button to start. Enter into the **Host Name** field the unique name (top right corner, under Epygi logo) for the Quadro device. The **Domain Name** text field requires the LAN side domain name which the Quadro belongs to.

For a basic configuration, the **LAN IP address** does not need to be changed, but if you must change it (for example, to integrate the device into an existing LAN), record the new LAN IP address and have it handy. You'll need it for subsequent access to Quadro's management from its LAN interface.

Please Note: The **Host Name** is very useful when many Quadro's are part of a network and one administrator has remote access to all of them. All Quadro pages show the host-name on the top right corner under Epygi logo.

The screenshot shows the 'System Configuration Wizard' window. At the top, there is a navigation bar with tabs: Main, System, Users, Telephony, Internet Uplink, and Network. The 'System' tab is selected. The Epygi logo is in the top right corner. The main title is 'System Configuration Wizard'. Below this, the 'System Configuration' section contains the following fields and controls:

- Host Name:
- Domain Name:
- LAN IP Configuration:
 - IP Address:
 - Subnet Mask:
- Navigation buttons:

At the bottom, there is a copyright notice: Copyright (C) 2003-2008 Epygi Technologies, Ltd. All rights reserved.

Fig. I- 10: System Configuration page

Clicking **Next** shows the page **DHCP Settings for the LAN Interface**.

DHCP Settings for the LAN Interface

If the DHCP server is enabled, the Quadro will automatically assign dynamic IP addresses to the stations connected to its LAN port.

If you didn't change the default LAN IP address of the Quadro, you also may leave the default values for the **IP Address Range**. Make sure your connected LAN devices belong to the same network as the LAN port of your Quadro.

Please Note: Make sure there is only one DHCP server on the LAN, otherwise, unpredictable network behavior can occur.

The screenshot shows the 'System Configuration Wizard' window with the 'Network' tab selected. The title is 'DHCP Settings for the LAN Interface'. There is an unchecked checkbox for 'Enable DHCP Server'. Below it, the 'Dynamic IP Address Range' is set from '172.30.0.100' to '172.30.0.254', with 'IP-Clipboard' buttons next to each field. The 'WINS Server' is set to '0.0.0.0' with an 'IP-Clipboard' button. Under 'Static mappings', it says 'None'. At the bottom are buttons for 'Previous', 'Next', 'Cancel', and 'Help'. The copyright notice at the bottom reads 'Copyright (C) 2003-2009 Epygi Technologies, Ltd. All rights reserved.'

Fig. I- 11: DHCP Settings for the LAN Interface page

Click on **Next** to display the **Regional Settings** page.

Regional Settings

If your Quadro is located outside of the United States, it is important to properly configure your line connections to the PSTN in your location.

The screenshot shows the 'System Configuration Wizard' window with the 'Network' tab selected. The title is 'Regional Settings and Preferences'. There is a dropdown menu for 'Your locale (location):' set to 'US'. Below it is a dropdown menu for 'Timezone:' set to '(GMT-06:00) Central Time (US & Canada)'. Under 'Choose Default GUI Theme', there are two radio buttons: 'Plain' and 'Dynamo', with 'Dynamo' selected. There is also an unchecked checkbox for 'Choose Theme on Login'. At the bottom are buttons for 'Previous', 'Next', 'Cancel', and 'Help'. The copyright notice at the bottom reads 'Copyright (C) 2003-2009 Epygi Technologies, Ltd. All rights reserved.'

Fig. I- 12: Regional Settings page

Proper configuration of **Regional Settings** is important for the functionality of the voice subsystem. The Regional Settings determine the proper telephony parameters on the LINE ports of the Quadro for the specified country. Select the country where the Quadro is lo-

cated. If you do not find your country in the list, pick the closest in your timezone.

The Quadro obtains the correct time automatically over the Internet from a time server. If you are not located in the US/Central standard time zone, you will need to change the **Timezone** to your region.

Click on **Next** to display the **Emergency and PSTN Access Code Settings** page.

Emergency and PSTN Access Code Settings

The screenshot shows the 'System Configuration Wizard' window. At the top, there are navigation tabs: 'Main', 'System', 'Users', 'Telephony', 'Internet Uplink', and 'Network'. The 'System' tab is selected. The 'Epygi quadro' logo is in the top right corner. The main title is 'System Configuration Wizard'. Below it, the section is 'Emergency Codes and PSTN Access Code Settings'. The instruction reads: 'Please enter all your Emergency Codes separated by commas and PSTN Access Code into following fields:'. There are two input fields: 'Emergency Codes' with the value '911' and 'PSTN Access Code' with a dropdown menu showing '9'. At the bottom, there are four buttons: 'Previous', 'Next', 'Cancel', and 'Help'. A copyright notice at the bottom left reads: 'Copyright (C) 2003-2008 Epygi Technologies, Ltd. All rights reserved.'

Fig. I- 13: Emergency and PSTN Access Code Settings page

You may enter your local specific emergency codes into the appropriate field. For example, in the United States the emergency number is 911, whereas in Germany it is 112,110. In case of an emergency you can then pick up any IP phone and dial your configured emergency code without any prefixes for PSTN calls. To make an emergency call if at least one ISDN timeslot is not attached to an SLA, press an appropriate extension button on your IP phone (Line1-Line3 on Aastra phones, Programmable Buttons 1 -6 on Snom phones by default) and dial the emergency code. If timeslots of all ISDN trunks are attached to SLAs, press an SLA button and then dial your configured emergency code (see [Step 4: Making/Receiving Calls](#)).

Please note: If all ISDN trunks are attached to SLAs, the emergency code specified on this page will not work if the **Blind Transfer to Extension** service for SLAs is activated with an empty access code and three-digit extensions are used on the system. For more information on the **Blind Transfer to Extension** Service, please see Manual II: Administrator's Guide.

The PSTN Access Code is the prefix number you choose to dial to tell the Quadro to "make this call over PSTN" (see [Step 4: Making/Receiving Calls](#)). Users in the United States will usually choose 9 here. European users usually would want to enter zero (0). If you do not enter anything into this field the currently configured PSTN Access Code will stay unchanged.

Please note: By default all ISDN timeslots are assigned to SLA lines to allow direct access to PSTN network (see [Step 2-B: Using Key System Emulation](#)). Therefore, in the default configuration dialing the Access Code to access the PSTN network is not required.

Click on **Next** to display the **Summary Page**.

Finishing the System Configuration Wizard

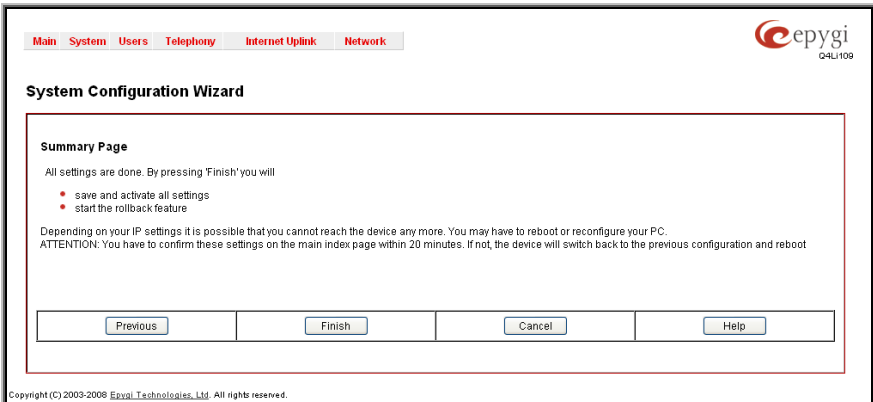

Fig. I- 14: System Configuration Wizard finishing page

Click on **Finish** to complete the System Configuration Wizard. The Quadro will then stop internal functions and apply the changes made in the Wizard.

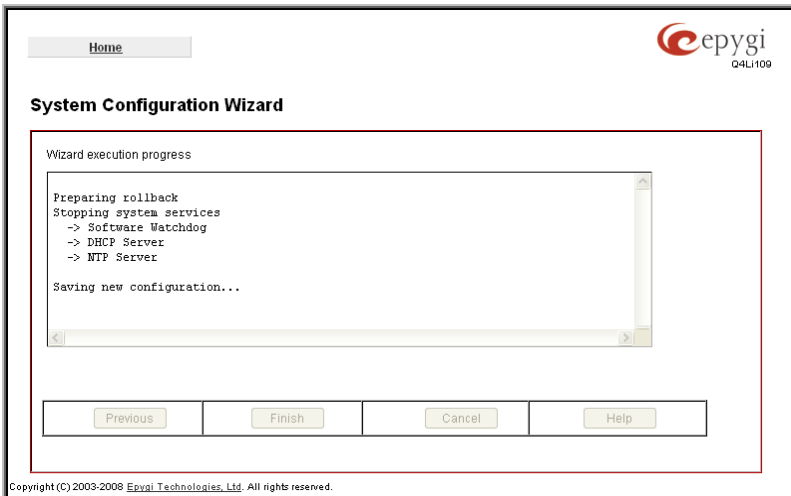

Fig. I- 15: Wizard Execution Progress page

After this is complete, the Quadro will reply with the **Confirm Settings** page requesting confirmation of the changes. Press on **OK** to confirm the settings.

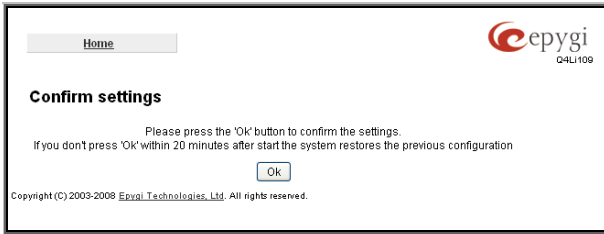

Fig. I- 16: Confirm Settings page

Please Note: You must confirm the settings within 20 minutes. Otherwise the device will **revert back to the previous configuration and reboot.**

Please Note: If you do not use DHCP for your LAN and you have changed your LAN settings, make sure that the IP address of the PC connected to Quadro is still within the specified IP address range, otherwise your PC may not establish a connection to Quadro.

If you changed the network configuration of the LAN, restart your LAN connection to receive a new IP address from the new network. Then you can access the Web Management of the Quadro on the new IP address you've assigned to the Quadro.

Step 2.3: Internet Configuration Wizard

Open the **Internet Configuration Wizard** by selecting the corresponding menu item on the **System** menu. The **Internet Configuration Wizard** is a tool for the administrator to configure the WAN settings and to adjust Quadro's connectivity in the global network. It must be run if Quadro is desired to be connected to the Internet.

The page **Getting Started** will be displayed:

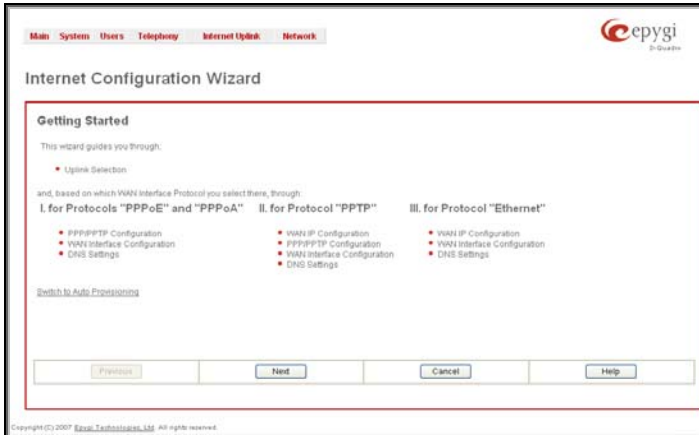

Fig. I- 17: Internet Configuration Wizard

This first page of the **Internet Configuration Wizard** is for informational purposes only and lists the items to be configured. Click on the **Next** button for the **Uplink Configuration** page.

Before configuring the WAN port to the Internet, you need to get the following information from your internet service provider:

- **Bandwidth** - how much is available upstream and downstream?
- **WAN IP Configuration** - is DHCP supported? If yes, no more information is needed. If DHCP is not supported, the following data is needed: the WAN IP address, the subnet mask, the IP address of the standard gateway and the IP address of the Domain Name Server (DNS).
- **MAC address** - needed when the ISP requires a specific MAC address for the WAN.

Additionally, for Point-to-Point Protocol over Ethernet (PPPoE) WAN interface, you need to get the following information from your internet service provider:

- **PPP Configuration** - does your ISP use a dynamic or fixed WAN IP address? If the WAN IP address is dynamic, no more information is needed. If the WAN IP address is fixed, you will have to enter it.
- **Authentication** - does your ISP require authentication? If authentication is required, information about the corresponding method (PAP, CHAP or MSCHAP) is needed including the username and password of the PPPoE account.

This information will be needed to be inserted in the Internet Configuration Wizard.

Uplink Configuration

Select the desired WAN Interface Protocol and enter the **WAN Interface Bandwidth** to assure the quality of IP calls.

The screenshot shows the 'Internet Configuration Wizard' window with the 'Uplink Configuration' tab selected. The 'WAN Interface Protocol' section has three radio buttons: **PPPoE** (selected), PPTP, and Ethernet. To the right, the 'WAN Interface Bandwidth' section has three input fields: 'Upstream' (10000), 'Downstream' (10000), and 'Min Data Rate' (0). Each field has a unit '(kb/s) (max. 10000)' or '(kb/s)' next to it. At the bottom, there are four buttons: 'Previous', 'Next', 'Cancel', and 'Help'. The copyright notice at the bottom left reads 'Copyright © 2007 Epygi Technologies, Ltd. All rights reserved.'

Fig. I- 18: Uplink Configuration

If the available bandwidth is used to the point where the quality of an additional IP call would suffer, then new IP calls are rejected.

The bandwidth provided by your ISP must be specified for both **Upstream** and **Downstream** fields. The default entry in both fields is **10000**, the maximum bandwidth of the 10 Mbit/s uplink module. For basic DSL and cable modem service in the United States, typical values are **300** for Upstream and **1500** for Downstream.

The **Min Data Rate** text field is used to specify the amount of bandwidth reserved for data applications. The value entered here needs to be smaller than the value specified for **Upstream Bandwidth**.

Specify the **WAN Interface Protocol** by choosing between available WAN interface protocols: **PPPoE** (Point to Point over Ethernet), **PPTP** (Point to Point Tunneling Protocol) and **Ethernet**. Use Ethernet for DHCP or static IP.

For **Ethernet**, clicking **Next** will display the **WAN IP Configuration** page. If **PPPoE** is the selected WAN Interface Protocol, the next page will be **PPP/PPTP Configuration**. For **PPTP** WAN Interface Protocol, **PPP/PPTP Configuration** page will follow the **WAN IP Configuration**.

WAN IP Configuration

Your Internet Service Provider (ISP) should provide this information.

- **Assign automatically via DHCP** - The parameters are set automatically by the ISP. This is common with cable modem and DSL service.
- **Assign Manually** requires the administrator to enter the external **IP Address**, the corresponding **Subnet Mask**, and the IP address of the **Standard Gateway**. This is common when you have a static IP address with your ISP.

The screenshot shows the 'Internet Configuration Wizard' with the 'WAN IP Configuration' step selected. The interface includes a navigation menu at the top with 'Main', 'System', 'Users', 'Telephony', 'Internet UpLink', and 'Network'. The 'e pygi' logo is in the top right. The main content area is titled 'Internet Configuration Wizard' and 'WAN IP Configuration'. Below this, it says 'IP configuration of the WAN interface'. There are two radio buttons: 'Assign automatically via DHCP' (unselected) and 'Assign manually' (selected). The 'Assign manually' section contains three rows of input fields: 'IP Address' with values 192, 168, 75, 235; 'Subnet Mask' with values 255, 255, 0, 0; and 'Default Gateway' with values 192, 168, 70, 10. Each field has an 'IP-Clipboard' button to its right. At the bottom of the form are four buttons: 'Previous', 'Next', 'Cancel', and 'Help'. A small copyright notice 'Copyright (C) 2007 Epygi Technologies, Ltd. All rights reserved.' is visible at the bottom left of the window.

Fig. I- 19: WAN IP Configuration page

Click on **Next** to display the **WAN Interface Configuration** page.

PPP/PPTP Configuration

Enter the IP address of the PPTP server into the **PPTP Server** text field.

Choose the encryption for the traffic over the PPTP interface from the **Encryption** drop down list.

Authentication Settings require the Username and the Password used for the authentication on the ISP server.

Dial Behavior radio buttons:

- **Dial Manually** - if this radio button is activated, a button will be displayed in the main management window that serves to switch the Internet connection on/off. When accessing the Internet, every station of the connected LAN has to connect to Quadro first.
- **Always connected** - Quadro stays in the always connected mode. This will allow Quadro always remain online in the network.

The **IP Address Assignment** field is used to specify the external IP address given to the Quadro. Usually it is a dynamic address but in some cases you may be given a static IP address.

The screenshot shows the 'Internet Configuration Wizard' window with the 'PPP / PPTP Settings' tab selected. The 'PPTP Server' field contains '172.11.169.80' and an 'IP-Clipboard' button. The 'Encryption' dropdown is set to '128 Bit'. Under 'Authentication Settings', 'User name' is 'quadro' and 'User password' is masked with asterisks. Under 'Dial behaviour', the 'Always connected' radio button is selected. Under 'IP Address Assignment', the 'Fixed IP Address' radio button is selected, and the 'Fixed IP Address' field contains '192.168.75.235' with an 'IP-Clipboard' button. The 'Keep connection alive' checkbox is checked. At the bottom, there are 'Previous', 'Next', 'Cancel', and 'Help' buttons.

Fig. I- 20: PPP/PPTP Configuration page

If your ISP assigns a dynamic IP address, activate the **Dynamic IP Address** radio button, otherwise activate the **Fixed IP Address** radio button and enter the IP address you were assigned by your ISP.

Keep Connection Alive checkbox enables keeping the connection alive by sending control packets dedicated for the link state verification.

Click the **Next** button to display the **WAN Interface Configuration** page.

WAN Interface Configuration

If your ISP requires a specific MAC address, (for example, for authentication), it can be entered on this page. The required MAC address can be entered into the **User defined** field. If a specific MAC address is not required, leave the default selection **This device** selected.

The screenshot shows the 'WAN Interface Configuration' section of the 'Internet Configuration Wizard'. At the top, there are navigation tabs: Main, System, Users, Telephony, Internet Uplink, and Network. The 'Internet Uplink' tab is active. The wizard title is 'Internet Configuration Wizard' with the 'epygi' logo. The main heading is 'WAN Interface Configuration'. Under 'MAC Address Assignment', there are two radio buttons: 'This device' (selected) and 'User defined'. The 'User defined' field contains the MAC address '1e fa 08 09 73 cd'. Below this, the 'Maximum Transfer Unit (MTU)' is set to '1400' bytes. At the bottom, there are four buttons: 'Previous', 'Next', 'Cancel', and 'Help'. A copyright notice at the bottom left reads 'Copyright (C) 2008 Epygi Technologies, Ltd. All rights reserved.'

Fig. I- 21: WAN Interface Configuration page

Use the **MTU** drop down list to select the maximum packet size on the Ethernet (in bytes). Click **Next** to display the **DNS Settings** page.

DNS Settings

For DNS, the selection is set to **Dynamically by Provider**. When using a static IP address, fixed values must be entered.

The screenshot shows the 'DNS Settings' section of the 'Internet Configuration Wizard'. It features the same navigation tabs as the previous page. The main heading is 'DNS Settings'. Under 'Name server assignment', there are two radio buttons: 'Dynamically by provider' (selected) and 'Fixed Nameserver Address'. The 'Fixed Nameserver Address' section contains two rows of input fields. The first row is for 'Name server' with IP addresses '192', '168', '70', and '10', followed by an 'IP-Clipboard' button. The second row is for 'Alternative Name server' with IP addresses '192', '168', '0', and '2', followed by an 'IP-Clipboard' button. At the bottom, there are four buttons: 'Previous', 'Next', 'Cancel', and 'Help'. A copyright notice at the bottom left reads 'Copyright (C) 2008 Epygi Technologies, Ltd. All rights reserved.'

Fig. I- 22: DNS Settings page

The Quadro will suggest the correct settings. If **Dynamically by Provider** is selected, the DNS server settings will be set automatically whenever a connection to the Internet is established.

If **Fixed Nameserver Address** is selected, manually enter the IP addresses provided by your ISP for the name server and the alternative name server.

Clicking **Next** shows the summary page of the Internet Configuration Wizard.

Finishing the Internet Configuration Wizard

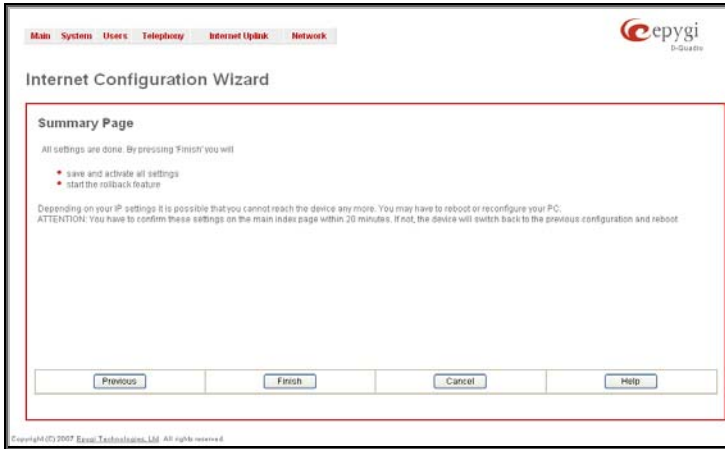

Fig. I- 23: Internet Configuration Wizard Summary page

Click the **Finish** button to complete the Internet Configuration Wizard. The Quadro will then stop internal functions and apply the changes made in the Wizard. After this is complete, the Quadro will display the **Confirm Settings** page requesting confirmation of the changes. Press the **OK** button to confirm the settings.

Please Note: the settings should be confirmed within 20 minutes; otherwise, the device will **revert back to the previous configuration and reboot**.

Step 2.4: Configuring the ISDN Settings

The Quadro4Li can be connected to a PBX or to the PSTN via ISDN trunks. The Quadro4Li may be connected to act as a **User** (if connected to PSTN) or as a **Network** (if connected to Legacy PBX).

Further, you are required to enter the ISDN settings your PSTN provider requires regarding framing, clocking, signaling used and so on. All these settings must be configured during the ISDN Wizard that starts when you press on the trunk in the **ISDN Trunk Settings** page accessible from the **Telephony** menu.

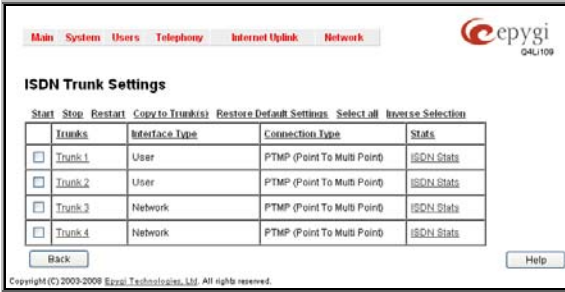

Fig. I-2: ISDN Settings page

The table on this page lists the available ISDN trunks of Quadro and their settings (trunk name, interface and connection type). The **ISDN Stats** link is displayed for every active ISDN trunk and leads to the page where the ISDN trunk and the traffic statistics can be viewed.

Run the ISDN Wizard

Before starting the ISDN Trunk configuration, please consult with your ISDN provider administrator to receive instructions for which settings are necessary to be configured.

Run the **ISDN Wizard** for each ISDN trunk to make sure that all settings are proper. To access **ISDN Wizard**, push the appropriate trunk number in the ISDN Trunk Settings table.

The **ISDN Wizard – ISDN Settings** allows you to choose the interface type and the connection type of the selected trunk(s).

The **Interface Type** drop down list allows you to select between the User and the Network interfaces. If a legacy PBX is connected, the interface configuration here should be **Network**. If an ISDN trunk from the CO (Central Office) is connected to the Quadro, the interface configuration here should be **User**.

The **Connection Type** manipulation radio button group allows you to choose the connection type for the selected trunk(s):

- **PTP (Point to Point)** – choose this option when only one ISDN device is attached to the Quadro. With this selection the TEI value should be defined manually later in the **ISDN Wizard**.
- **PTMP (Point to Multi Point)** – choose this option when one or more ISDN devices are attached to the Quadro. With this selection the TEI value will be defined automatically. This selection also allows you to use the MSN services.

Please Note: Consult with your CO operator or network administrator before configuring the ISDN connection type.

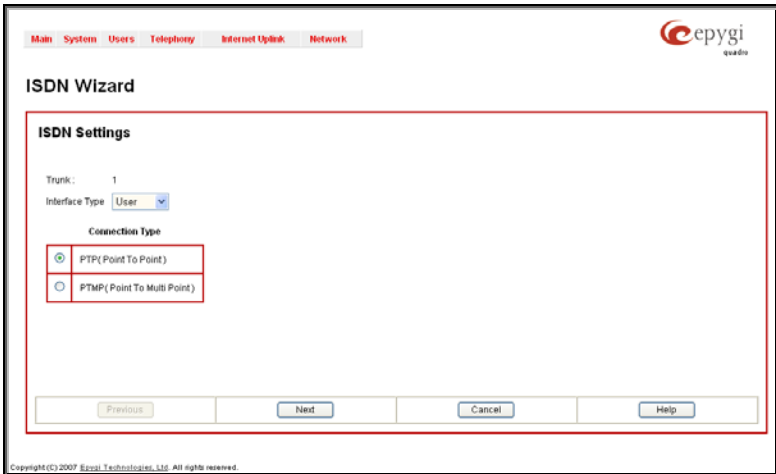

Fig. II-3: ISDN Wizard – ISDN Settings

The **ISDN Wizard - Page 2** content is dependent on the connection type selected on the previous page of **ISDN Wizard**:

For **PTMP (Point to Multi Point)** connection type selection, the next page in the ISDN Wizard is **ISDN PTMP Settings**.

The **ISDN PTMP Settings** page is used to turn on the MSN configuration. It is recommended to enable the MSN when there are multiple ISDN devices connected to the same ISDN bus. If the MSN is enabled on this page, the next page will require the MSN table configuration.

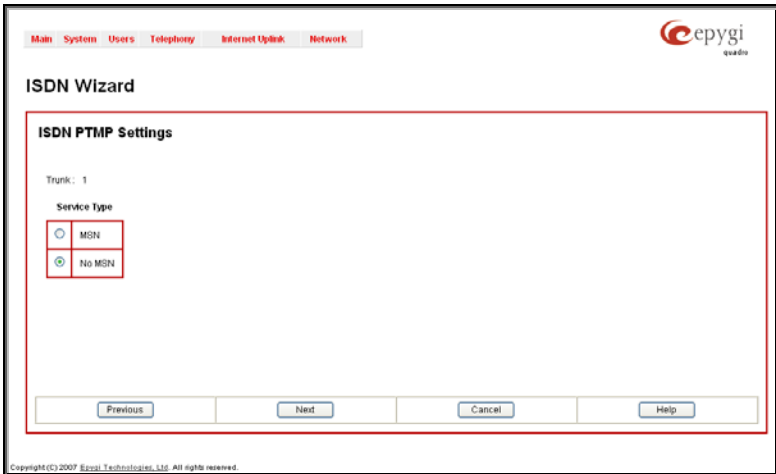

Fig. II-4: ISDN Wizard – ISDN PRMP Settings

For **PTMP (Point to Multi Point)** connection type with MSN service selected, the **Routing Settings** page is used to allocate MSN numbers to the certain destinations on the Quadro. MSN numbers allow you to manage the ISDN numbers and to route them accordingly. The MSN number can be assigned to Quadro extensions, to the Auto Attendant, or to the routing client with two kinds of call routing possibilities, where incoming calls will be routed.

The drop-down lists in the **MSN Number** column require the MSN numbers defined on the Quadro.

Please Note: At least one MSN number should be defined in this list. The system displays an error message if the same MSN number is used twice in the drop down lists on this page.

The **Route Incoming Call to** drop-down lists allow you to select the destination where the incoming call addressed to the certain MSN number will be routed. Choosing the **Routing with inbound destination number** selection will automatically use the initially dialed number to connect the destination without any additional dialing. For **PTP (Point to Point)** connection type or for **PTMP (Point to Multi Point)** connection type with MSN disabled, this page contains only one **Route Incoming Call to** drop-down list.

Selecting **Use Default outgoing Caller ID** allows you to overwrite the source caller information with the one specified in the **Default outgoing Caller ID** text field when placing outgoing calls toward the CO. The **Default outgoing Caller ID** text field requires the Quadro identification number that should be registered and recognized at the CO for outgoing calls. If this checkbox is enabled but no value is defined in **Default outgoing Caller ID**, empty caller information will be sent to the CO. If this checkbox is disabled, the source caller information will be forwarded to the CO.

Select the **Advanced Settings** checkbox if you wish to adjust trunk L2 and L3 Settings manually, otherwise leave this checkbox unselected to use the system default values.

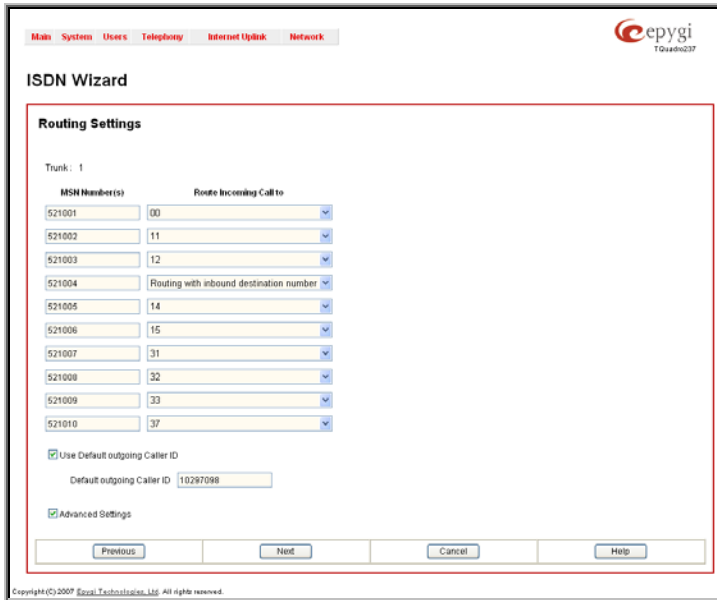

Fig. II-5: ISDN Wizard – Routing Settings

The **ISDN Wizard – L2&L3 Settings** is used for advanced configuration only and contains L2&L3 Settings. This page only appears when the **Advanced Settings** checkbox is selected on the previous page of the wizard. This page contains the following components:

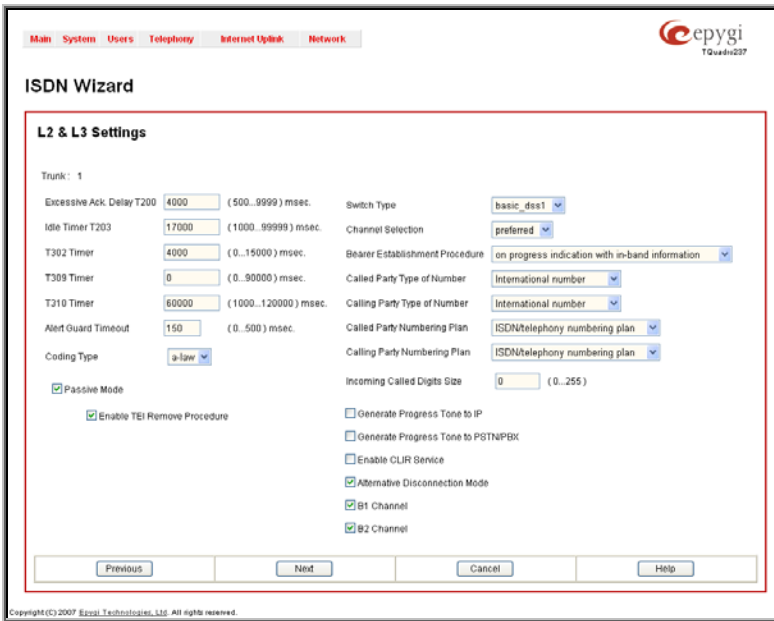

Fig. II-6: ISDN Wizard – I2&L3 Settings

ISDN L2 Timers:

- **Excessive Ack. Delay T200** configures the period in milliseconds (numeric values from 500 to 9999) between the transmitted signaling packet and its acknowledgement received.
- **Idle Timer T203** configures the period in milliseconds (numeric values from 1000 to 99999) for the ISDN client idle timeout.

ISDN L3 Timers:

- The **T302 Timer** text field requires the value for the T302 timer in milliseconds (digit values from 0 to 15000). It indicates that the time frame system is waiting for a digit to be dialed. When the timer expires, it initiates the call.
- **T309 Timer** requires the value for the T309 timer in milliseconds (numeric values from 0 to 90000). It is responsible for call steadiness during link disconnection within the period equal to this timer value. If the value in this field is zero (0), the T309 timer will be disabled.
- **T310 Timer** requires the value for the T310 timer in milliseconds (numeric values from 1000 to 120000). It is responsible for the outgoing call steadiness when CALL PROCEEDING is already received from the destination but call confirmation (ALERT, CONNECT, DISC or PROGRESS) has not yet arrived.
- **Alert Guard Timeout** requires the value for the Alert Guard Timer in milliseconds (numeric values from 0 to 500) between CALL PROC and ALERT messages. **Alert Guard Timer** it is used when Quadro is connected to a slow legacy ISDN-PBX. Recommended values are:

- fast connection (0ms);
- normal (150ms), default;
- slow ISDN-PBX (350ms);
- very slow ISDN-PBX (500ms).

The **Coding Type** drop down list allows you to select between **a-law** and **mu-law** coding types.

The **Switch Type** is another configuration parameter that depends on the Service Provider.

The **Passive Mode** checkbox is used to leave the ISDN Layer1 connection in the Slave mode. When this checkbox is selected, Layer1 remains idle when calls are not available. When this checkbox is not selected, Quadro keeps its Layer1 always active. This checkbox enables the **Enable TEI Remove Procedure** checkbox. With the **Enable TEI Remove Procedure** checkbox is selected, the trunk will lose the assigned TEI when entering into passive mode on the Layer 2. The **Passive Mode** and **Enable TEI Remove Procedure** checkboxes are present only for connection types different from **PTP (Point to Point)** selected on the first page of **ISDN Wizard**. In case if **PTP (Point to Point)** connection type is selected on the first page of the ISDN Wizard, these two checkboxes are replaced with a **TEI Address** text field that requires the channel number (digit values from 0 to 63) for connection establishment between the CO and the ISDN client.

Channel Selection is used to select between the **Preferred** and **Exclusive** B channel selection methods. For **Preferred** channel selection, the CO answers to the call request by the first available timeslot. With the **Exclusive** channel selection, the CO should feedback only by the timeslot asked in the call request.

The **Bearer Establishment Procedure** drop down list allows selecting the session initiation method on the B channel. One of the following options can be selected for the transmission path completion prior to receipt of a call acceptance indication:

- on channel negotiation at the destination interface
- on progress indication with in-band information
- on call acceptance

The **Calling Party Type of Number** drop down list allows you to select the type identifying the origin of call.

The **Called Party Type of Number** drop down list allows you to select the type identifying the subaddress of the called party of the call.

The **Called Party Numbering Plan** and **Calling Party Numbering Plan** drop down lists correspondingly indicate the numbering plan of the called party's and calling party's number.

The **Incoming Called Digits Size** text field indicates the number of received digits (in a range from 0 to 255) required to establish a call. When this field has a "0" value, the system uses either the timeout defined in the T302 field or the **Sending Complete Information element** messages to establish a call. Independent on the value in this field, **Sending Complete Information element** and the pound sign always result in call establishment.

The **Generate Progress tone on IP** checkbox selection will generate the progress tone to IP.

When **Generate Progress Tone to PSTN/PBX** checkbox is selected, Quadro generates ring tones to callers during ISDN call dialing. This feature is mainly applicable to 2-stage dialing mode.

Enable CLIR Service checkbox selection enables Calling Line Identification Restriction (CLIR) service which displays the incoming caller ID only if Presentation Indication is allowed on the remote side. Otherwise, if CLIR service is disabled, caller ID will be unconditionally displayed.

When the **Alternative Disconnection Mode** checkbox is not selected, Quadro will disconnect the call as soon as the disconnect message has been received from the peer. When the checkbox is selected, Quadro's user may hear a busy tone when peer has been disconnected.

The **B1 Channel** and **B2 Channel** checkboxes enables/disables timeslots for voice transfer. Disabling the timeslot will prevent both incoming and outgoing calls.

Step 2-A: Using IP Lines

Before starting the IP Lines configuration, the appropriate IP phone should be connected to the Quadro either to the WAN or LAN port. If the phones are placed on the Quadro WAN, which is assumed by the default configuration, please ensure that the **Connect IP phones from WAN side** checkbox is enabled on the **Line Settings** page (see Fig. I-24).

The Quadro4Li provides two options for configuring IP phones:

- The **Plug-and-Play** option is available for supported SIP phones only. The list of these phones is given [below](#). The **Plug-and-Play** option does not require any specific configuration except that the **Enable PnP for IP lines** checkbox should be enabled on the **Line Settings** page (see Fig. I-24).
- The **Auto-Configuration** option is available for tested and supported SIP phones. The list of tested SIP phones is given [below](#). The **Auto-Configuration** option (described in detail below) requires specifying some basic parameters on the Quadro and restarting the phone.

Please note: With the both options, IP phones download their configuration from the Quadro's TFTP server. Therefore, if the phones obtain their network parameters from a DHCP server other than the Quadro's built-in DHCP server, please ensure that either the server does not provide the "TFTP server" parameter or the parameter is set to the Quadro's LAN or WAN IP address depending on the location of IP phones.

When using the automatic-configuration option, each IP line should be configured individually from the **Telephony** menu, **Line Settings** page.

Open from the **Telephony** menu and choose **Line Settings** page. The **IP Line Settings** page is displayed.

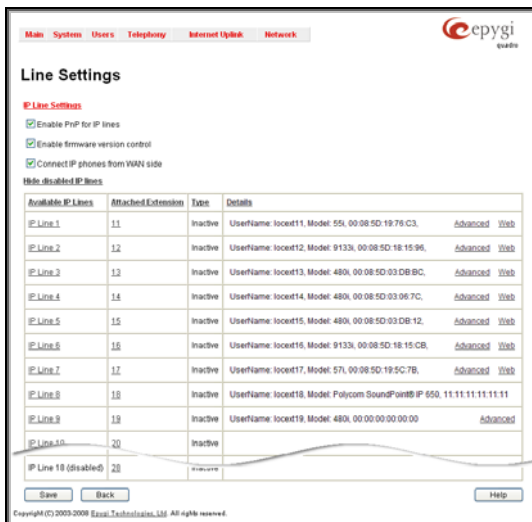

Line Settings

IP Line Settings

- Enable PnP for IP lines
- Enable firmware version control
- Connect IP phones from WAN side

Hide disabled IP lines

Available IP Lines	Attached Extension	Type	Details
IP Line 1	11	Inactive	Username: locext11, Model: 55, 00:08:5D:19:76:C3, Advanced Web
IP Line 2	12	Inactive	Username: locext12, Model: 9133, 00:08:5D:18:15:96, Advanced Web
IP Line 3	13	Inactive	Username: locext13, Model: 480, 00:08:5D:03:DB:BC, Advanced Web
IP Line 4	14	Inactive	Username: locext14, Model: 480, 00:08:5D:03:06:7C, Advanced Web
IP Line 5	15	Inactive	Username: locext15, Model: 480, 00:08:5D:03:DB:12, Advanced Web
IP Line 6	16	Inactive	Username: locext16, Model: 9133, 00:08:5D:18:15:CB, Advanced Web
IP Line 7	17	Inactive	Username: locext17, Model: 57, 00:08:5D:19:5C:7B, Advanced Web
IP Line 8	18	Inactive	Username: locext18, Model: Polycom SoundPoint® IP 650, 11:11:11:11:11:11
IP Line 9	19	Inactive	Username: locext19, Model: 480, 00:00:00:00:00:00 Advanced
IP Line 10	20	Inactive	
IP Line 18 (disabled)	28	Inactive	

Save Back Help

Copyright (C) 2003-2009 Essal Technology, Ltd. All rights reserved.

Fig. I-24: Line Settings page

Click on the IP Line number to enter the **IP Lines Settings** page.

Fig. I- 25: IP Line Settings page

Select the **SIP Phone** radio button. Select the SIP IP phone model from the **Phone Model** drop-down list.

Please Note: If your IP phone is not listed in the **Phone Model** drop-down list, select the **Other** option from the list to configure the SIP phone manually. The SIP phone's configuration is different dependent on the SIP phone model. For more information about SIP Phone configuration, refer to the SIP phone manual or user's guide.

Insert the SIP Phone's **MAC address** in the corresponding fields. The MAC address of an IP phone is usually printed on the back of the phone's base unit.

In the **Line Appearances** text box, enter the number for simultaneous calls supported by the SIP IP phone – which is the sum of the number of active and held calls. For example, if this field is set to **1**, only one active call is possible to have on the phone and making or accepting a second call while the other is on hold will not be allowed. Note, that this number depends on the phone brand and model, and cannot exceed the number of simultaneous calls supported by the phone.

Username and **Password** are required to be inserted for this selection. They should match on both Quadro and SIP phone for a successful connection. The Password field is checked against its strength and you may see how strong is your inserted password right below that field. To achieve the well protected strong password minimum 8 characters of letters in upper and lower case, symbols and numbers should be used. If you are unable to define a strong password, press **Choose Generated Password** to use one of system defined strong passwords.

The **Transport** drop down list is used to select the SIP protocol transport layer - UDP, TCP or TLS. For TLS you may activate the TLS certificate update mechanism from IP Phone to obtain the latest certificate generated by the Quadro.

The **Use Session Timer** enables the SIP session timer for the corresponding IP line. This checkbox enables advanced mechanisms for connection activity checking. This option al-

lows both user agents and proxies to determine if the SIP session is still active.

Reset the SIP Phone. After restart, the appropriate configuration will be automatically downloaded from the Quadro to the SIP Phone.

Some SIP phones require only reboot for configuration download. Other SIP Phones may require additional configuration. For example, by default IP Dialog SIP Tone II is in non-auto-provisioning mode, therefore the user has to manually enable it on the phone.

To make sure the IP line is configured properly, do the following:

- Go to **Quadro Status- SIP Registration status – Registered IP Lines** to see if IP Line registration is successful.
- Dial *74 to get the line information.
- Make outgoing and accept incoming calls.

Supported SIP Phones

Below is the list of SIP phones that are officially supported by Epygi and can be configured to work with Quadro4Li using its Plug-and-Play configuration option:

- snom 190,
- snom 200,
- snom 220,
- snom 300 (also supports FVC),
- snom 320 (also supports FVC),
- snom 360 (also supports FVC),
- snom 370 (also supports FVC),
- snom 820 (also supports FVC),
- snom 870 (also supports FVC),
- snom MeetingPoint (also supports FVC),
- Aastra 480i (also supports FVC),
- Aastra 480iCT,
- Aastra 9112i (also supports FVC),
- Aastra 9133i (also supports FVC),
- Aastra 9143i(33i)(also supports FVC),
- Aastra 9480i(35i)(also supports FVC),
- Aastra 9480iCT,
- Aastra 6751i (also supports FVC),
- Aastra 6753i (also supports FVC),
- Aastra 6755i (also supports FVC),
- Aastra 6757i (also supports FVC),
- Aastra 6757iCT,
- Aastra 6730i (also supports FVC),
- Aastra 6731i (also supports FVC),
- Polycom SoundPoint IP 300SIP,
- Polycom SoundPoint IP 330SIP,
- Polycom SoundPoint IP 331SIP,
- Polycom SoundPoint IP 335SIP,
- Polycom SoundPoint IP 450SIP,
- Polycom SoundPoint IP 501SIP,
- Polycom SoundPoint IP 550SIP,
- Polycom SoundPoint IP 601SIP,
- Polycom SoundPoint IP 650SIP,
- Polycom SoundStation IP 6000,
- Grandstream BT200,
- Grandstream GXP2000,
- Linksys SPA921,
- Linksys SPA922,
- Linksys SPA941,
- Linksys SPA942,
- Yealink T20,

- Yealink T22,
- Yealink T26,
- Yealink T28.

Tested SIP phones

Below is the list of SIP phones that are tested with the Quadro but may cause problems when using some of the IP Phone related features:

- CISCO 7960
- IpDialog ST201
- Polycom SoundPoint IP 300SIP
- Polycom SoundPoint IP 330SIP
- Polycom SoundPoint IP 331SIP
- Polycom SoundPoint IP 501SIP
- Polycom SoundPoint IP 550SIP
- Polycom SoundPoint IP 601SIP
- Polycom SoundPoint IP 650SIP
- Polycom SoundStation IP 6000
- POLYCOM VVX 1500
- SIPUra SPA 841
- Snom 190
- Snom 200
- Snom 220
- Snom M3
- Swissvoice IP 10S
- Thomson ST 2030 SIP
- Berkshire (ATL) 5000
- Grandstream BT10
- Grandstream BT200
- Grandstream GXP2000
- Linksys SPA921
- Linksys SPA922
- Linksys SPA941
- Linksys SPA942
- Yealink T28
- Aastra MBU400
- Telematrix IP550 Spectrum Plus
- Telematrix 3300IP

Step 2-B: Using Key System Emulation

The **Key System Emulation** is a widely used service in legacy PBXs simplifying the direct connection to the available PSTN lines. On the Quadro4Li, the usage of Key System Emulation services is limited to the IP phones attached to the Quadro through the available IP lines and provides direct connection to the available PSTN lines and SIP networks. In its turn, the IP phones are limited to the following models with the perspective to enlarge the list of recommended IP phones in the future:

- Aastra 480i
- Aastra 57i
- Snom 370
- Aastra 9133i
- Snom 320
- Aastra 55i
- Snom 360

The Key System Emulation feature allows to:

- Have a direct connection to the available PSTN lines and SIP networks behind the Quadro by pushing the programmable keys on the IP phone.
- Monitor the availability and status of all configured external lines via programmable keys on the IP Phones.
- Place the call on hold from one IP phone and pick it from another IP phone attached on the Quadro.

Go to the **Telephony** menu of the Quadro's Web Management for **Key System Emulation** service configuration.

By default, the 8 SLA lines of the Quadro4Li device are in inactive mode. To activate an SLA line, assign an ISDN timeslot(s) or SIP number to the SLA line and configure the IP phone's programmable buttons.

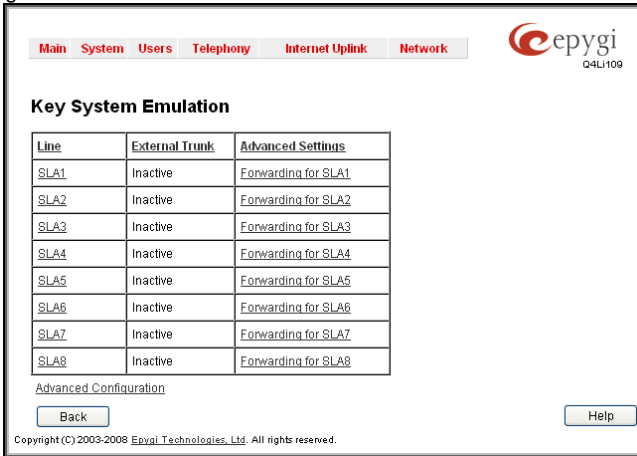

Fig. I-26: Key System Emulation page

To assign an ISDN timeslot to an SLA, open the **Telephony**→**Key system Emulation** page and click on the corresponding SLA line. The Key System Emulation page for the SLA line opens (see Figure I-27). On this page, choose the **PSTN** radio button and select an ISDN timeslot. For how to use SLA lines for SIP calls, see the section below.

To configure the IP phones to use the Key System Emulation service of the Quadro, the programmable keys should be adjusted correspondingly. To do so, go to the Telephony menu, **Line Settings**, move to the **IP Line Settings** page. If the IP Line is already configured, push the **Advanced** link for the corresponding IP line in the **Details** column, otherwise configure the IP line first as indicated in the chapter [Step 2-A: Using IP Lines](#).

The **Advanced** link leads you to the **Programmable Keys Configuration** page where programmable keys for the corresponding IP phone can be configured. Assign the SLA line to the preferred Programmable Key and save the settings. Once the corresponding IP phone is restarted, the selected programmable key will be responsible for the calls on the configured SLA line. The corresponding programmable key will be blinking during incoming calls on that SLA line. To make an outgoing call, the caller will simply need to push that programmable key to get access to the ISDN network (in default configuration, as indicated above).

The **Advanced Configuration** link moves to the **Advanced Configuration** page that is used to enable/disable the blind transfer service from SLA lines to extensions or their voice mailboxes.

Please Note: By assigning an ISDN timeslot to an SLA line, it becomes unavailable for calls through Auto Attendant or Call Routing Table. If you wish to leave ISDN timeslot available for calls through the Auto Attendant or Call Routing Table, do not assign all ISDN timeslots to SLAs.

Using SLA Lines for SIP Calls

You may want to use the SLA lines of the Key System Emulation for SIP calls through certain SIP servers instead of assigning them to the PSTN lines. To do so, go to the **Key Sys-**

tem Emulation page from the **Telephony** menu of the Quadro's Web Management. Push the corresponding SLA line number to get its configuration page.

Fig. I-27: Key System Emulation – SLA# page

The **SLA Name** text field is used to insert the preferred name for the corresponding SLA line. On the IP phones with the display available, this name is visible on the display next to the programmable key.

A group of manipulation radio buttons allow you to configure the SLA line:

- **Inactive** - disables the corresponding SLA line.
- **PSTN** - allows you to assign the SLA line to the available PSTN lines on the Quadro. This selection disappears when there are no more unassigned PSTN lines available.

Attention: By assigning a PSTN line to an SLA line, it becomes unavailable for calls through Auto Attendant or Call Routing Table.

- **SIP** - used to assign the SLA line to the certain SIP account. This selection has two sub-selections:
 - **Custom Settings** - used to define a SIP server and SIP registration parameters. The following parameters are required for this selection:
 - Username** - the registration username on the SIP server.
 - Password** - the registration password on the SIP server.
 - SIP Server** - the IP address or the host name of the SIP server.
 - SIP Port** - the port of the SIP server.
 - Authentication User Name** - an identification parameter to reach the SIP server. It should be provided by the SIP service provider and can be requested for some SIP servers only. For others, the field should be left empty.
 - Outbound Proxy Host Address** and **Port** - the IP address or the host name and the port number of the outbound proxy SIP server.

- **Use SLA Settings** - choose this selection to use the SIP settings of another SLA line. This selection is also used to allow multiple line appearances on the same ITSP provider. The **SLA** drop down list is used to select the SLA line whose SIP settings will be used for the corresponding SLA line. The **DID** text field requires an optional identification number used by some ITSP providers to differentiate between the call appearances on the selected line. The **Use DID for outgoing calls** indicates whether the specified DID number should be included in the Caller ID of calls initiated from the SLA. If this checkbox is enabled, the DID number will be sent along with the SIP username. This checkbox should be enabled if the IP-PSTN provider authorizes the users by their DIDs.

For this configuration scenario, choose the **SIP** option with **Custom Settings**. Provide all required information of the SIP server. Save the settings.

Now your SLA line will be handling calls through the defined SIP server. The IP phone can be called by the SIP username of its SLA line. All incoming calls from that SIP server will be blinking on the corresponding programmable key of the IP phone, as described in the previous chapter. For outgoing calls through the defined SIP server, the user should simply push the programmable key assigned to the corresponding SLA line, and dial the SIP number of the called user.

Please Note: Quadro can also be configured in a mixed Key System Emulation mode, i.e. having one SLA lines assigned to the SIP servers will still make possible to have others assigned to the available PSTN lines.

Disabling the Key System Emulation

To disable the Key System Emulation, disconnect the ISDN timeslot from the SLA by inactivating the SLA or by changing the SLA assignment to a SIP server. To do that, go to the **Key System Emulation** page from the **Telephony** menu, push the SLA line to which the corresponding ISDN line is assigned, choose the **Inactive** or **SIP** option and save the selection (in case of SIP, additional information should be provided as described above). Perform the same steps for other SLA lines, as needed. Now your SLA lines are available to be used through the Auto Attendant and Call Routing.

Step 2-C: Using Receptionist

If you wish to use the Receptionist's features, the Receptionist should be set up on the Quadro. The Quadro's basic configuration should be done in the same way as described in the Step 2.

The Receptionist related setup, with detailed instructions on how to configure the Quadro and the attached IP Phones, is described in the "**Receptionist Setup on Quadro**" document, which you can find at the Epygi's Web portal.

Step 3: Registering on Epygi's Technical Support

It is recommended that you register your Quadro on the Epygi Technical Support web page. Registration will give you access to the Technical Support Database. There, you can submit requests concerning technical problems as well as refer to the Frequently Asked Questions (FAQ) section. In addition, the technical support page allows users to download new firmware, manuals and other information. You can access the support section only if you are registered. Additionally, registration at Epygi's Technical Support web page gives you the username and password to login to the Epygi SIP Server.

To register, you need to know the serial number of your Quadro, which is located on a label on the bottom of Quadro. You will also need the date of purchase. Next, open the Epygi home page (www.epygi.com), select **Support** and click on **Registration Form**. The online registration page will appear:

Complete all fields and record the **Login Name** and **Password** in a safe place. You will need it for the SIP server.

Please Note: In some cases, the Quadro units will be shipped preconfigured from the factory with the Support login and password already set up. In this case, an information sheet is included in the packaged contents indicating the username and password to access Epygi's Online Support and the Epygi SIP Server.

Fig. I- 28: Online Registration page

Step 4: Making/Receiving Calls

Please Note: The Quadro's default settings are sufficient to make SIP phone calls. It is not necessary to make any changes unless the user wants to create new SIP extensions on the Epygi SIP Server, create a private directory for several Quadro units, or use alternate VoIP services. Refer to the Manual II - Administrator's Guide for more information on these configurations.

- To make a call to the PSTN, dial **9** and the local phone number. You may accelerate the dialing process by adding the # after the last digit, e.g., 9 + 972-661-1335#. You are making a local call through the PSTN. It is assumed an ISDN trunk is connected to the Quadro.

Please Note: In case you had changed the default value of the **PSTN Access Code** in the System Configuration Wizard to something other than 9, you will need to dial your chosen digit instead.

- To make a VoIP call to a user on the remote Quadro, lift the handset and dial **8 + SIP Address** (of the user on the remote Quadro) + #. You are calling over the Internet to a remote user.

Please Note: Epygi has a SIP Address test line to test newly provisioned Quadro devices. Call **8 + 99 + #** and you will hear a message if the call was successful. This message comes from a Quadro in one of our offices. SIP Addresses are described below.

- Received IP calls will ring the extensions automatically.
- Received PSTN calls will be directed to the Quadro's default Auto Attendant (00).

Using the Default SIP Addresses

Making Internet IP calls is simple with the Quadro. By default, every standard (analog) telephone connected to one of Quadro's phone lines functions as an IP phone. If you open the **Extensions Management** page, you will see that some **SIP Addresses** are available, one attached to the Auto Attendant and one to each extension. These SIP addresses are the IP telephone numbers of these extensions. Anyone with a Quadro or any other SIP IP device on the Internet can place a call to **SIPAddress@sip.epygi.com** and the call will ring the associated extension.

Under **Extensions Management**, you may edit the **Display Names** to assign extensions to people.

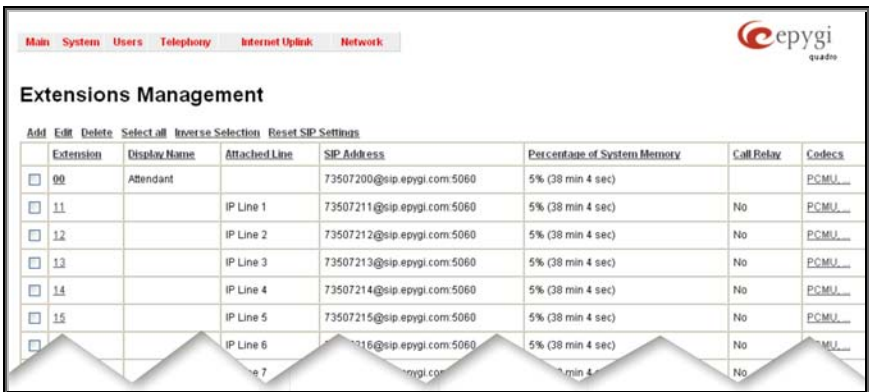

Fig. I- 29: Extensions Management page

To do so, click on the box in the first column next to the extension to edit and click the **Edit**

button. When the page opens, go to **General Settings** and edit the **Display Name** and click the **Save** button. Do not change any other settings at this time. For more information on the **Extensions Management** settings, refer to the Administrator's Guide and [Appendix: Registering on Epygi's SIP Server](#) of this document. The default SIP addresses are based on internal parameters unique to each Quadro device. If the Quadro undergoes a factory reset, the default addresses will be restored.

If you want to establish a dial plan between several Quadro units in a private group, refer to [Appendix: Registering on Epygi's SIP Server](#), which describes how to change the default, SIP addresses on the Epygi SIP server and in the Quadro devices. With the directory service, you can create a private directory accessible from the Internet using a user-name/password. This service is enabled through the Epygi SIP Server.

Appendix: Changing the Admin Password

For security reasons, it is recommended that you change the default admin password. The username of the administrator (**admin**) cannot be changed.

To change the administrator password, go to the **System** menu, **User Rights Management**.



Fig. I- 30: User Right Management page

Choose **admin** from the list and press the **Change Password** functional button from the **User Right Management** page toolbar.

For **Administrator** account the page contains two parts - one for **GUI Access Password**, the other one for **Phone Access Password**.



Fig. I- 31: Change Password page

The **GUI Access Password** offers the following components:

- The **Old Password** field requires the current password of the **Administrator**. An error message prevents entering the wrong password.
- The **New Password** field requires a new password for the **Administrator**. Reentering the new password in the **Confirm New Password** field will confirm the new password. Up to twenty (0-20) digits and symbols are allowed.

The **Phone Access Password** offers the following components:

- The **Old Password** field requires the current password of the **Administrator**. An error message prevents entering the wrong password.
- The **New Password** field requires a new password for the **Administrator**. Reentering the new password in the **Confirm New Password** field will confirm the new password. The password can consist of numeric values only. Up to twenty

(0-20) digits are allowed. A corresponding warning appears if any other symbols are inserted.

For **Local Administrator** or **Extension** accounts it offers the following components:

- The **Old Password** field requires the current password of the **Administrator**. An error message prevents entering the wrong password.
- The **New Password** field requires a new password for the **Administrator**. Reentering the new password in the **Confirm New Password** field will confirm the new password. The password can consist of numeric values only. Up to twenty (0-20) digits are allowed. A corresponding warning appears if any other symbols are inserted.

Note: If **Administrator** is changing the **Local Administrator** or **Extension** passwords or **Local Administrator** is changing the **Extension** password then the **Old Password** field is not displaying

Attention: It is highly recommended to define a proper and non-empty password on this page if the extension is being used for the Call Relay service from the Quadro's [Auto Attendant](#).

Write down the password somewhere and keep it in a secure place. If the password is lost, a factory reset will be required on the unit (see Administrator's Guide, Hardware Overview). All settings are lost after a factory reset. After a factory reset the default password (19) will be restored.

Appendix: Configuring NAT Traversal

NAT or Network Address Translation is a common feature used to expand the use of connected PCs and other networked devices without having to use multiple global Internet public IP addresses. Most ISP's will assign one public IP address to each customer that is connected to the Internet. The customer can use a router to provide NAT capability and create a private network of PCs and other devices not visible from the Internet. This method offers security and also eliminates the need to assign global Internet public IP addresses to each device on the LAN.

The Quadro initiates and receives SIP calls from the Internet (or the network connected to the WAN port). To receive SIP calls, the Quadro must be able to receive packets from the SIP server or any other device that is trying to make an incoming call. If the Quadro is placed behind a router with NAT, like most basic routers on the market today, the Quadro will not be able to receive calls. To resolve this issue, either STUN must be enabled on the Quadro or SIP NAT traversal must be set up in the router and in the Quadro to route the incoming calls properly.

Please Note: NAT traversal only works with Internet connections that have static IP addresses. Verify from your provider that this is the case for your Internet connection. Some ISPs provide dynamic IP addresses that may change from time to time, and are not appropriate for SIP NAT traversal.

Please Note: If you have more than one router in series between the Quadro and the Internet, the same port forwarding setup must be configured on each router.

NAT Traversal Setup

- Install the Quadro behind the router. If the Quadro is configured with its factory default settings, it is already configured for DHCP and will obtain an IP address automatically from the router.
- Connect a PC to the Quadro LAN port and power it up.
- Verify the Quadro can connect to the Internet by opening a browser window and browsing to a familiar WEB site. If the Quadro cannot reach the Internet, verify the LAN/WAN LEDs and the cabling. Verify the Quadro is set up for DHCP on the WAN and that the router has the DHCP server enabled for the devices behind it.
- Find the address of the router and log into the router. Refer to the router's user manual on how to open the router configuration.
- Set up port forwarding on the router to forward UDP ports 5060, 6000-6099 to the IP address assigned to the Quadro. You can see the IP address of the Quadro in the System menu under Status, submenu Network Status. The IP address will be listed as the WAN IP address. Your router also may indicate the IP address assigned to the Quadro.
- Find out the public Internet address (WAN IP address) of the router. To do so, open a browser and go to www.whatismyip.com. The site will return your public Internet IP address. Record this IP address.
- From the **Telephony** menu of the Quadro Management go to the **NAT Traversal Settings** page, go to **General Settings** and set the enable **NAT Traversal for SIP** radio buttons selection to **Force**. **Save** the selection.

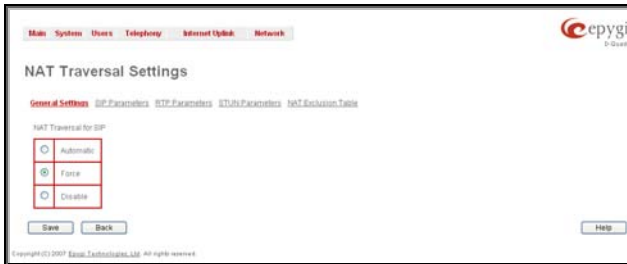

Fig. I- 32: NAT Traversal Settings – General Setting

Go to **SIP Parameters** page.

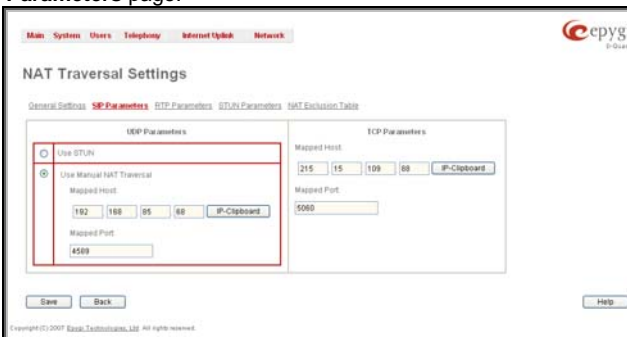

Fig. I- 33: NAT Traversal Settings - SIP Parameters

Select **Use Manual NAT Traversal** and enter the WAN IP address of the router into the **Mapped Host** text field. For **Mapped Port**, enter the router's corresponding port number, in this case **5060**. **Save** the entries.

- Go to the **RTP Parameters** page and select **Use Manual NAT Traversal**.

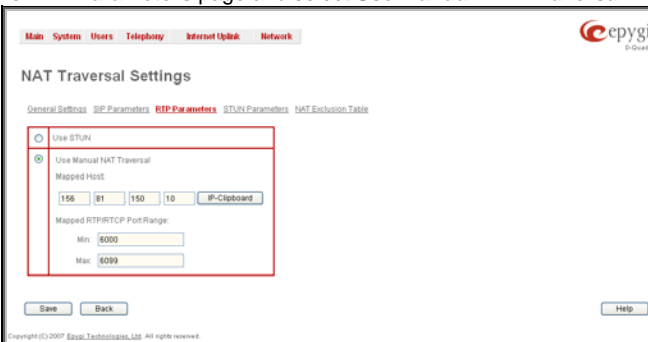

Fig. I- 34: NAT Traversal Settings - RTP Parameters

- Enter the WAN IP address of the router into the **Mapped Host** text field. Set the **Mapped RTP/RTCP Port Range** according to the values specified on the router, in this case to **6000 (Min)** and **6099 (Max)**, respectively. Click the **Save** button to save the contents.

The Quadro will activate the settings and register the extensions on the Epygi SIP Server after a few minutes. You can verify the settings from the main **Quadro Management** menu under **Status** in the **SIP Registration Status** section.

Appendix: Registering on Epygi's SIP Server

You may login directly to Epygi's SIP Server if you have registered your Quadro at Epygi's Technical Support Center. If you have not registered with Epygi Technical Support, you cannot login to the Epygi SIP Server.

Login to the Epygi SIP Server at www.epygi.com. Click on **SIP, Login here**. Use the same login name and password you used for Epygi Support for Customer Login.

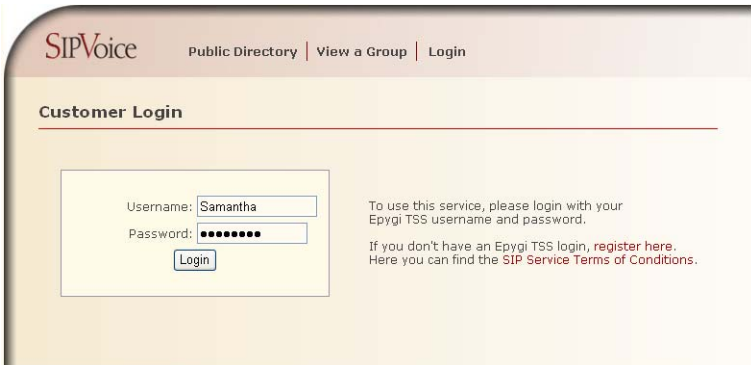

Fig. I- 35: SIP Services Login page

Read the **SIP Service Terms and Conditions** and accept it to proceed. The displayed page now welcomes you and allows you to **Subscribe a New Extension**.

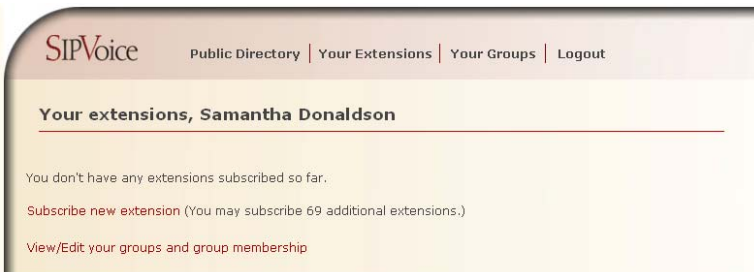

Fig. I- 36: SIP Services Welcome page

Selecting **Subscribe a New Extension** leads you to a page where you can enter the user information as shown below. The **Extension Nr.** is the eight-digit SIP number assigned to your extension. The first five are fixed by the SIP Server and cannot be changed and the last three are user defined. Notice the check box to enable this extension to be shown in the Epygi **Public SIP Directory**.

Please Note: If you enable this extension to be shown in the Epygi **Public SIP Directory**, all information related to this extension will be published in the Public SIP Directory, which is accessible by anyone from the Internet. To maintain privacy, do not check this box.

SIPVoice Public Directory | Your Extensions | Your Groups | Logout

Add new extension

Check here to make this entry available in the Epygi SIP phone directory:

Extension Nr. 30256-321

First Name Samantha

Last Name Donaldson

Location Seattle

Company OmniTec

Description Headquarters

email mantha.donaldson@omnitec.com

Authentication password

Retype Password

Assign to groups: none joined

[Back without save](#)

Fig. I- 37: SIP Services Add New Extension page

The **Authentication password** validates the entry and must match the password entered on the Quadro later. Make sure to record the name, Authentication Password and SIP extension number for entry into the Quadro later.

Save will store the entered information and conclude the basic SIP registration. The following page then will be displayed:

SIPVoice Public Directory | Your Extensions | Your Groups | Logout

Your extensions, Samantha Donaldson

EXT.#	STAT.	NAME	LOCATION	COMPANY	DESCRIPTION	EMAIL	PUB	GROUPS
edit 30256321	unreg.	Samantha Donaldson	Seattle	OmniTec, Ltd.	Headquarters	yes	-	delete

[Subscribe new extension](#) (You may subscribe 9 additional extensions.)

[View/Edit your groups and group membership](#)

Fig. I- 38: SIP Services Your Extension page

This table shows **unreg.** in the **Stat.** column. This entry will change to **reg.** when the required settings in the Quadro are complete and the Quadro successfully registers on the SIP Server.

Repeat this for all four extensions on the Quadro and the Auto Attendant.

Configuring Quadro Extensions

Once the SIP server has the created extensions with the user information, create these extensions in the Quadro devices. Once they are entered in the Quadro, they will be registered and can then be used.

Login into the Quadro and go to **Extensions Management**.

Extension	Display Name	Attached Line	SIP Address	Percentage of System Memory	Call Relay	Codes
00	Attendant		73507200@sip.epygi.com:5060	5% (38 min 4 sec)		PCMU...
11		IP Line 1	73507211@sip.epygi.com:5060	5% (38 min 4 sec)	No	PCMU...
12		IP Line 2	73507212@sip.epygi.com:5060	5% (38 min 4 sec)	No	PCMU...
13		IP Line 3	73507213@sip.epygi.com:5060	5% (38 min 4 sec)	No	PCMU...
14		IP Line 4	73507214@sip.epygi.com:5060	5% (38 min 4 sec)	No	PCMU...
15		IP Line 5	73507215@sip.epygi.com:5060	5% (38 min 4 sec)	No	PCMU...
16		IP Line 6	73507216@sip.epygi.com:5060	5% (38 min 4 sec)	No	PCMU...

Fig. I- 39: Extensions Management page

Select the first extension to change by clicking the appropriate checkbox and press **Edit** functional button. The **Extensions Management – Edit Entry** page will be displayed.

Go to the **General Settings** page and adjust the **Display Name** as needed.

Extensions Management - Edit Entry

General Settings - 11

Display Name:

Password:

Confirm Password:

Attached Line:

Use Kickback

Allow Call Relay

Login Allowed

Show on Public Directory

Percentage of Total Memory: %

Fig. I- 40: Extensions Management - Edit Entry – General Settings page

Go to the **SIP Settings** page to enter the **SIP Registration Settings** you received from the Epygi SIP server.

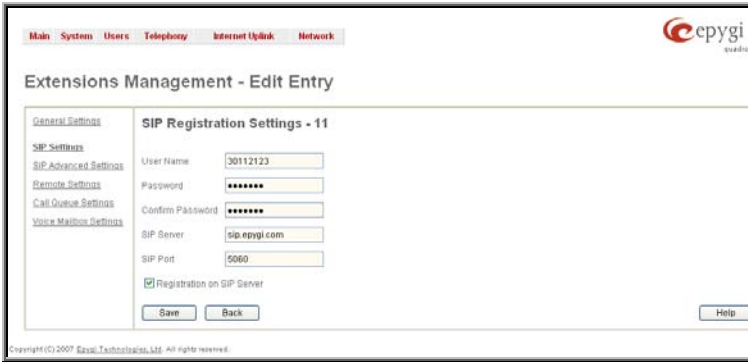

Fig. I- 41: Extensions Management - Edit Entry – SIP Settings page

- Enter the SIP registration number displayed in the column **Ext#** into the text field **Registration User Name**.
- In the Password field, enter the password you specified when registering at the SIP server and confirm it in the field below.
- In Registration SIP Server, the selected SIP server address must be entered. If you use the Epygi SIP server, you may leave the default entry sip.epygi.com.
- Most SIP server providers, including Epygi, use port 5060 as the Registration SIP Port. You may leave the default entry as is.
- Select Registration on SIP Server if you want to establish and receive IP calls.
- Click the Save button to activate the settings.

Other settings of the extension might be also modified from **Extensions Management – Edit Entry** page (refer to the Manual II - Administrator’s Guide).

Your settings will be verified, then after a few seconds the **Extensions Management** page is updated with the changes as shown in the below example, Fig.I-42.

Extension	Display Name	Attached Line	SIP Address	Percentage of System Memory	Call Relay	Codec
00	Attendant		73507200@sip.epygi.com:5060	5% (38 min 4 sec)		PCMU...
11	Samantha	IP Line 1	30112123@sip.epygi.com:5060	5% (38 min 4 sec)	No	PCMU...
12		IP Line 2	73507212@sip.epygi.com:5060	5% (38 min 4 sec)	No	PCMU...
13		IP Line 3	73507213@sip.epygi.com:5060	5% (38 min 4 sec)	No	PCMU...
14		IP Line 4	73507214@sip.epygi.com:5060	5% (38 min 4 sec)	No	PCMU...
15		IP Line 5	73507215@sip.epygi.com:5060	5% (38 min 4 sec)	No	PCMU...
16		IP Line 6	73507216@sip.epygi.com:5060	5% (38 min 4 sec)	No	PCMU...
17		IP Line 7	73507217@sip.epygi.com:5060	5% (38 min 4 sec)	No	PCMU...

Fig. I- 42: Extensions Management page

If you go back to Epygi’s SIP Server, you will find the value **reg.** for this number in the column **Stat. Reg.** This will indicate that the Quadro has successfully registered the new number. If this does not happen after a few minutes, again verify the SIP Number and passwords.

Appendix: Checking the Connections

If the system doesn't seem to be working properly, even when all the cables are connected properly, it may be helpful to **Start Network Diagnostics**: The WAN link, IP configuration, gateway, DNS server, and STUN-NAT will all be checked.

To start diagnostics, open the **System's** menu item **Diagnostics** and click **Start Network Diagnostics**.

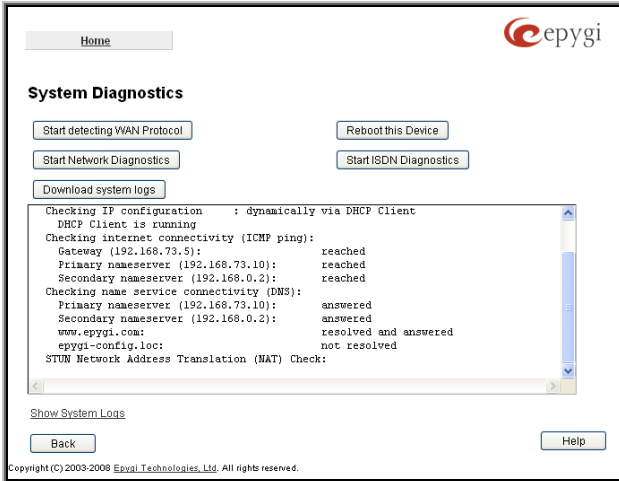

Fig. I- 43: System Diagnostics - Network Diagnostics page

If the test passes, the output of the system may look as follows:

Basic Tests:

```

Checking for physical link:                WAN link ok
Checking IP configuration:                dynamically via DHCP Client
DHCP Client is running
Checking internet connectivity (ICMP ping):
Gateway:                reached
Primary nameserver:    reached
Secondary nameserver:  not configured
www.epygi.com:        reached
STUN Network Address Translation (NAT) Check:
External visible address: 212.126.210.179
Detected NAT type      : Restricted cone
Performing MTU Discovery:
preparing system
Sending UDP Datagram of size 1500        got answer
clean up
Largest usable MTU size is: 1500 Bytes
Test successful.
  
```

Depending on where the test is failing, the diagnostic can give some advice on how to solve the problem. See the example below of a failed test:

Basic Tests:

```

Checking for physical link:                no WAN link
Please check the physical connection of the WAN interface. Cable not
plugged or broken?
Test failed.
  
```

If diagnostics are successful, but you are still unable to place a call to 899# then check the SIP registration status.

Open the SIP Registration Status page using the Quadro management **System** menu item **Status**. Besides the SIP registration information for the auto attendant and each connected extension, the **Detected Connection Type** is shown. If Quadro is placed behind a NAT router and the STUN is enabled, the detected connection type and the IP address of this router's WAN port are displayed.

Quadro Status - SIP Registration Status

Refresh in 541 seconds

General Information
 Network Status
 Lines Status
 Memory Status
 Hardware Status
SIP Registration Status

Registration on SIP Servers

Extension	Reg. Name	Server	Registered	Registration Time
00	228000	sip.epygi.loc	Yes	15-Feb-2007 00:49:54
11	716998411	sip.epygi.com	Yes	15-Feb-2007 00:33:45
12	716998412	sip.epygi.com	Yes	15-Feb-2007 00:33:46
13	716998413	sip.epygi.com	Yes	15-Feb-2007 00:33:48
14	716998414	sip.epygi.com	Yes	15-Feb-2007 00:22:47
15	716998415	sip.epygi.com	Yes	15-Feb-2007 00:33:47
16	716998416	sip.epygi.com	Yes	15-Feb-2007 00:33:47
17	716998417	sip.epygi.com	Yes	15-Feb-2007 00:33:48
18	716998418	sip.epygi.com	Yes	15-Feb-2007 00:33:48
19	716998419	sip.epygi.com	Yes	15-Feb-2007 00:33:48
20	716998420	sip.epygi.com	Yes	15-Feb-2007 00:33:48

Detected connection type: Full Cone NAT (external IP: 195.69.162.135:5069)

Registered IP Lines

Username	Binding IP Address	Registration Time	Registration Expires In
locend27	172.20.0.254	15-Feb-2007 00:50:24	9 min 0 sec
locend28	172.30.0.249	15-Feb-2007 00:59:13	9 min 39 sec
locend29	172.30.0.253	15-Feb-2007 00:55:01	5 min 27 sec
locend30	172.30.0.250	15-Feb-2007 00:56:07	6 min 33 sec

SIP Trunks to Slave Devices

Trunk Name	Slave Device IP	Slave Device Port	Registration State	Registration Date/Time
No items in list.				

SIP Trunks to Master Devices

Trunk Name	Master Device IP	Master Device Port	Registration State	Registration Date/Time
No items in list.				

Back Help

Copyright (C) 2007 Epygi Technologies Ltd. All rights reserved.

Fig. I- 44: SIP Registration Status page

Quadro cannot work behind your router if **Detected Connection Type** is one of the following:

- Unknown connection - unexpected error
- Symmetric NAT
- Symmetric Firewall
- Blocked UDP

If you get one of the above mentioned Detected Connection Types, either connect the Quadro in front of the router, or configure NAT traversal manually as explained in [Appendix: Configuring NAT Traversal](#).

If you are unable to resolve your problems, please send us a technical support request on the **Support** section of <http://www.epygi.com/>. Please prepare a system log file and attach it to your request.

To download the system logs, open the **System Diagnostics** page from **System** menu **Diagnosics** and click **Download System Logs**.

Appendix: Pin Assignment of ISDN

Pin	Signal
1	N.C.
2	N.C.
3	SSR1
4	SSX1
5	SSX2
6	SSR2
7	N.C.
8	N.C.

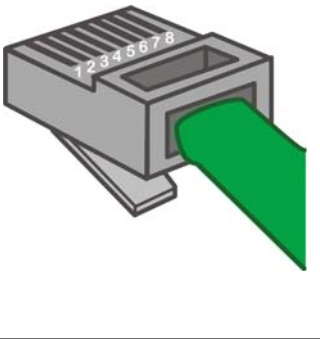

Fig. I- 45: Pin Assignment of ISDN in User mode

Pin	Signal
1	N.C.
2	N.C.
3	SSX1
4	SSR1
5	SSR2
6	SSX2
7	N.C.
8	N.C.

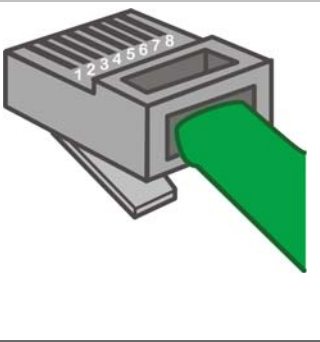

Fig. I- 46: Pin Assignment of ISDN in Network mode



Epygi Technologies, Ltd.

Copyright 2003 - 2011
Epygi Technologies, Ltd.
All rights reserved

QIG-QUADRO-10-04