

# Yealink

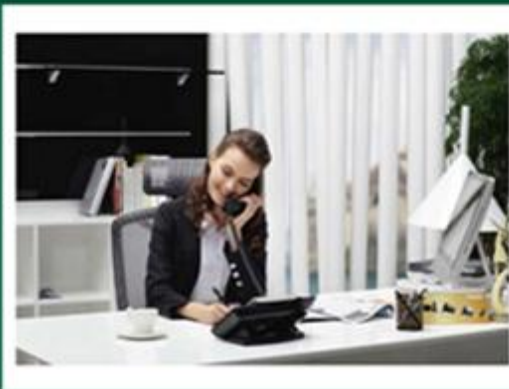

## SIP-T2xP and SIP-T19P IP Phone Family Administrator Guide

## Copyright

### Copyright © 2013 YEALINK NETWORK TECHNOLOGY

Copyright © 2013 Yealink Network Technology CO., LTD. All rights reserved. No parts of this publication may be reproduced or transmitted in any form or by any means, electronic or mechanical, photocopying, recording, or otherwise, for any purpose, without the express written permission of Yealink Network Technology CO., LTD. Under the law, reproducing includes translating into another language or format.

When this publication is made available on media, Yealink Network Technology CO., LTD. gives its consent to downloading and printing copies of the content provided in this file only for private use but not for redistribution. No parts of this publication may be subject to alteration, modification or commercial use. Yealink Network Technology CO., LTD. will not be liable for any damages arising from use of an illegally modified or altered publication.

## Warranty

THE SPECIFICATIONS AND INFORMATION REGARDING THE PRODUCTS IN THIS GUIDE ARE SUBJECT TO CHANGE WITHOUT NOTICE. ALL STATEMENTS, INFORMATION, AND RECOMMENDATIONS IN THIS GUIDE ARE BELIEVED TO BE ACCURATE AND PRESENTED WITHOUT WARRANTY OF ANY KIND, EXPRESS OR IMPLIED. USERS MUST TAKE FULL RESPONSIBILITY FOR THEIR APPLICATION OF PRODUCTS.

YEALINK NETWORK TECHNOLOGY CO., LTD. MAKES NO WARRANTY OF ANY KIND WITH REGARD TO THIS GUIDE, INCLUDING, BUT NOT LIMITED TO, THE IMPLIED WARRANTIES OF MERCHANTABILITY AND FITNESS FOR A PARTICULAR PURPOSE. Yealink Network Technology CO., LTD. shall not be liable for errors contained herein nor for incidental or consequential damages in connection with the furnishing, performance, or use of this guide.

## Declaration of Conformity



Hereby, Yealink Network Technology CO., LTD. declares that this phone is in conformity with the essential requirements and other relevant provisions of the CE, FCC.

## CE Mark Warning

This device is marked with the CE mark in compliance with EC Directives 2006/95/EC and 2004/108/EC.

## Part 15 FCC Rules

This device is compliant with Part 15 of the FCC Rules. Operation is subject to the following two conditions:

1. This device may not cause harmful interference, and
2. This device must accept any interference received, including interference that may cause undesired operation.

## Class B Digital Device or Peripheral

Note: This device is tested and complies with the limits for a Class B digital device, pursuant to Part 15 of the FCC Rules. These limits are designed to provide reasonable protection against harmful interference in a residential installation. This equipment generates, uses, and can radiate radio frequency energy and, if not installed and used in accordance with the instructions, may cause harmful interference to radio communications. However, there is no guarantee that interference will not occur in a particular installation. If this equipment does cause harmful interference to radio or television reception, which can be determined by turning the equipment off and on, the user is encouraged to try to correct the interference by one or more of the following measures:

1. Reorient or relocate the receiving antenna.
2. Increase the separation between the equipment and receiver.
3. Connect the equipment into an outlet on a circuit different from that to which the receiver is connected.
4. Consult the dealer or an experienced radio/TV technician for help.

## WEEE Warning



To avoid the potential effects on the environment and human health as a result of the presence of hazardous substances in electrical and electronic equipment, end users of electrical and electronic equipment should understand the meaning of the crossed-out wheeled bin symbol. Do not dispose of WEEE as unsorted municipal waste and have to collect such WEEE separately.

## Customer Feedback

We are striving to improve our documentation quality and we appreciate your feedback. Email your opinions and comments to [DocsFeedback@yealink.com](mailto:DocsFeedback@yealink.com).

# GNU GPL INFORMATION

Yealink IP phone firmware contains third-party software under the GNU General Public License (GPL). Yealink uses software under the specific terms of the GPL. Please refer to the GPL for the exact terms and conditions of the license.

The original GPL license, source code of components licensed under GPL and used in Yealink products can be downloaded from Yealink web site:

<http://www.yealink.com/GPLOpenSource.aspx?BaseInfoCatId=293&NewsCatId=293&CatId=293>.



## About This Guide

This guide is intended for administrators who need to properly configure, customize, manage, and troubleshoot the IP phone system rather than the end-users. It provides details on the functionality and configuration of the IP phones.

Many of the features described in this guide involve network settings, which could affect the IP phone performance in the network. So an understanding of IP networking and prior knowledge of IP telephony concepts are necessary.

## Documentations

This guide covers the SIP-T28P, T26P, T22P, T21P, T20P and T19P IP phones. The following related documents are available:

- Quick Installation Guides, which describe how to assemble IP phones.
- Quick Reference Guides, which describe the most basic features available on IP phones.
- User Guides, which describe the basic and advanced features available on IP phones.
- Auto Provisioning Guide, which describes how to provision IP phones using the configuration files.
- Configuration Conversion Tool User Guide, which describes how to convert and encrypt the configuration files using the Configuration Conversion Tool.
- <y0000000000xx>.cfg and <MAC>.cfg template configuration files.
- IP Phones Deployment Guide for BroadWorks Environments, which describes how to configure the BroadSoft features on the BroadWorks web portal and IP phones.

For support or service, please contact your Yealink reseller or go to Yealink Technical Support online <http://www.yealink.com/Support.aspx>.

## In This Guide

The information detailed in this guide is applicable to the firmware version 71 or higher. The firmware format likes x.x.x.x.rom. The second x from left must be greater than or equal to 71 (e.g., the firmware version of SIP-T28P IP phone: 2.71.0.125.rom). This administrator guide includes the following chapters:

- Chapter 1, “[Product Overview](#)” describes the SIP components and SIP IP phones.
- Chapter 2, “[Getting Started](#)” describes how to install and connect IP phones and the configuration methods.

- Chapter 3, "[Configuring Basic Features](#)" describes how to configure the basic features on IP phones.
- Chapter 4, "[Configuring Advanced Features](#)" describes how to configure the advanced features on IP phones.
- Chapter 5, "[Configuring Audio Features](#)" describes how to configure the audio features on IP phones.
- Chapter 6, "[Configuring Security Features](#)" describes how to configure the security features on IP phones.
- Chapter 7, "[Upgrading Firmware](#)" describes how to upgrade firmware of IP phones.
- Chapter 8, "[Resource Files](#)" describes the resource files that can be downloaded by IP phones.
- Chapter 9, "[Troubleshooting](#)" describes how to troubleshoot IP phones and provides some common troubleshooting solutions.
- Chapter 10, "[Appendix](#)" provides the glossary, reference information about IP phones compliant with RFC 3261, SIP call flows and the sample configuration files.

## Summary of Changes

This section describes the changes to this guide for each release and guide version.

### Changes for Release 71, Guide Version 71.127

Major updates have occurred to the following sections:

- [Distinctive Ring Tones](#) on page 127

### Changes for Release 71, Guide Version 71.126

Documentation of the newly released SIP-T19P and SIP-T21P IP phones has also been added.

### Changes for Release 71, Guide Version 71.125

Major updates have occurred to the following sections:

- [Appendix B: Time Zones](#) on page 243

## Changes for Release 71, Guide Version 71.120

Major updates have occurred to the following sections:

- [Configuring DSS Key](#) on page 376

## Changes for Release 71, Guide Version 71.110

The following sections are new for this version:

- [Hot Desking](#) on page 155
- [TR-069 Device Management](#) on page 187
- [IPv6 Support](#) on page 190

Major updates have occurred to the following sections:

- [Configuring Network Parameters Manually](#) on page 24
- [Softkey Layout](#) on page 60
- [Directed Call Pickup](#) on page 104
- [Distinctive Ring Tones](#) on page 127
- [Automatic Call Distribution](#) on page 143
- [Action URL](#) on page 160
- [Server Redundancy](#) on page 162
- [VLAN](#) on page 172
- [Transport Layer Security](#) on page 205
- [Local Contact File](#) on page 225

## Changes for Release 70, Guide Version 70

The following sections are new for this version:

- [Configuring Basic Network Parameters](#) on page 22
- [Contrast](#) on page 42
- [Backlight](#) on page 43
- [Logo Customization](#) on page 58
- [Softkey Layout](#) on page 60
- [Key as Send](#) on page 63
- [Call Log](#) on page 67
- [Live Dialpad](#) on page 72
- [Auto Answer](#) on page 76

- [Call Completion](#) on page 77
- [Anonymous Call](#) on page 79
- [Anonymous Call Rejection](#) on page 80
- [Busy Tone Delay](#) on page 86
- [Return Code When Refuse](#) on page 87
- [Early Media](#) on page 88
- [180 Ring Workaround](#) on page 88
- [Use Outbound Proxy in Dialog](#) on page 90
- [SIP Session Timer](#) on page 91
- [Session Timer](#) on page 92
- [Call Return](#) on page 112
- [Transfer via DTMF](#) on page 122
- [Intercom](#) on page 123
- [Music on Hold](#) on page 142
- [Automatic Call Distribution](#) on page 143
- [Message Waiting Indicator](#) on page 145
- [Multicast Paging](#) on page 147
- [Call Recording](#) on page 152
- [LLDP](#) on page 169
- [VLAN](#) on page 172
- [VPN](#) on page 175
- [Quality of Service](#) on page 177
- [Configuring Audio Features](#) on page 193
- [Secure Real-Time Transport Protocol](#) on page 211
- [Appendix B: Time Zones](#) on page 243
- Phone user interface for each feature

Major updates have occurred to the following sections:

- [Creating Dial Plan](#) on page 32
- [Transport Layer Security](#) on page 205
- [Encrypting Configuration Files](#) on page 213
- [Troubleshooting](#) on page 229
- Web user interface for each feature

## Changes for Release 70, Guide Version 2.0

The following sections are new for this version:

- [Dialog Info Call Pickup](#) on page 110
- [Web Server Type](#) on page 115
- [Tones](#) on page 131
- [Hot Desking](#) on page 155
- [Action URL](#) on page 160
- [Action URI](#) on page 159
- [Resource Files](#) on page 221
- [Appendix C: Configuration Parameters](#) on page 246
- [Appendix F: Sample Configuration File](#) on page 445

Major updates have occurred to the following sections:

- [Creating Dial Plan](#) on page 32
- [Phone Lock](#) on page 48
- [Time and Date](#) on page 50
- [Busy Lamp Field](#) on page 138



# Table of Contents

<b>About This Guide .....</b>	<b>v</b>
Documentations.....	v
In This Guide .....	v
Summary of Changes .....	vi
Changes for Release 71, Guide Version 71.127.....	vi
Changes for Release 71, Guide Version 71.126.....	vi
Changes for Release 71, Guide Version 71.125.....	vi
Changes for Release 71, Guide Version 71.120.....	vii
Changes for Release 71, Guide Version 71.110.....	vii
Changes for Release 70, Guide Version 70.....	vii
Changes for Release 70, Guide Version 2.0.....	ix
<b>Table of Contents .....</b>	<b>xi</b>
<b>Product Overview.....</b>	<b>1</b>
VoIP Principle.....	1
SIP Components.....	2
SIP IP Phone Models.....	3
Physical Features of IP Phones .....	4
Key Features of IP Phones.....	10
<b>Getting Started.....</b>	<b>13</b>
Connecting the IP Phones .....	13
Initialization Process Overview .....	16
Verifying Startup .....	18
Configuration Methods.....	18
Phone User Interface.....	18
Web User Interface .....	18
Configuration Files.....	19
Reading Icons .....	20
Configuring Basic Network Parameters .....	22
DHCP .....	22
Configuring Network Parameters Manually .....	24
PPPoE .....	27
Configuring Transmission Methods of the Internet Port and PC Port .....	28
Configuring PC Port Mode .....	30

Creating Dial Plan .....	32
Replace Rule .....	33
Dial-now .....	34
Area Code.....	37
Block Out.....	38

## **Configuring Basic Features ..... 41**

Contrast .....	42
Backlight.....	43
User Password .....	45
Administrator Password .....	46
Phone Lock .....	48
Time and Date .....	50
Language .....	55
Loading Language Packs .....	56
Specifying the Language to Use.....	57
Logo Customization .....	58
Softkey Layout.....	60
Key as Send .....	63
Hotline .....	65
Call Log.....	67
Missed Call Log .....	68
Local Directory.....	69
Live Dialpad.....	72
Call Waiting.....	72
Auto Redial.....	75
Auto Answer.....	76
Call Completion.....	77
Anonymous Call.....	79
Anonymous Call Rejection .....	80
Do Not Disturb.....	82
Busy Tone Delay.....	86
Return Code When Refuse .....	87
Early Media.....	88
180 Ring Workaround .....	88
Use Outbound Proxy in Dialog .....	90
SIP Session Timer .....	91
Session Timer .....	92
Call Hold.....	94
Call Forward .....	96
Call Transfer .....	101
Network Conference .....	102
Transfer on Conference Hang Up .....	103
Directed Call Pickup.....	104



Group Call Pickup.....	107
Dialog Info Call Pickup.....	110
Call Return.....	112
Call Park.....	113
Web Server Type.....	115
Calling Line Identification Presentation.....	116
Connected Line Identification Presentation.....	118
DTMF.....	118
Suppress DTMF Display.....	121
Transfer via DTMF.....	122
Intercom.....	123
Outgoing Intercom Calls.....	123
Incoming Intercom Calls.....	125
<b>Configuring Advanced Features.....</b>	<b>127</b>
Distinctive Ring Tones.....	127
Tones.....	131
Remote Phone Book.....	133
LDAP.....	135
Busy Lamp Field.....	138
Music on Hold.....	142
Automatic Call Distribution.....	143
Message Waiting Indicator.....	145
Multicast Paging.....	147
Sending RTP Stream.....	147
Receiving RTP Stream.....	149
Call Recording.....	152
Hot Desking.....	155
Action URL.....	157
Action URI.....	160
Server Redundancy.....	163
SIP Server Domain Name Resolution.....	166
LLDP.....	169
VLAN.....	172
VPN.....	175
Quality of Service.....	177
Network Address Translation.....	179
SNMP.....	181
802.1X Authentication.....	183
TR-069 Device Management.....	187
IPv6 Support.....	190
<b>Configuring Audio Features.....</b>	<b>193</b>

Headset Prior .....	193
Dual Headset .....	194
Audio Codecs .....	195
Acoustic Clarity Technology.....	199
Acoustic Echo Cancellation .....	199
Voice Activity Detection .....	200
Comfort Noise Generation .....	201
Jitter Buffer .....	202
<b>Configuring Security Features.....</b>	<b>205</b>
Transport Layer Security.....	205
Secure Real-Time Transport Protocol.....	211
Encrypting Configuration Files .....	213
<b>Upgrading Firmware.....</b>	<b>217</b>
<b>Resource Files .....</b>	<b>221</b>
Replace Rule Template .....	221
Dial-now Template.....	222
Softkey Layout Template.....	223
Local Contact File .....	225
Remote XML Phone Book.....	226
Specifying the Access URL of Resource Files .....	227
<b>Troubleshooting .....</b>	<b>229</b>
Troubleshooting Methods .....	229
Viewing Log Files.....	229
Capturing Packets .....	232
Enabling Watch Dog Feature .....	232
Getting Information from Status Indicators.....	233
Analyzing Configuration File .....	233
Troubleshooting Solutions .....	234
Why is the LCD screen blank? .....	234
Why doesn't the IP phone get an IP address? .....	234
Why does the IP phone display "No Service"? .....	235
How do I find the basic information of the IP phone?.....	235
Why doesn't the IP phone upgrade firmware successfully?.....	235
Why doesn't the IP phone display time and date correctly? .....	235
Why do I get poor sound quality during a call? .....	235
What is the difference between a remote phone book and a local phone book? .....	236
What is the difference between user name, register name and display name? .....	236
How to reboot the IP phone remotely? .....	236

Why does the IP phone use DOB format logo file instead of popular BMP, JPG and so on? .....	237
How to increase or decrease the volume? .....	237
What will happen if I connect both PoE cable and power adapter? Which has the higher priority?.....	237
What is auto provisioning? .....	237
What is PnP? .....	237
Why doesn't the IP phone update the configuration? .....	238
What do "on code" and "off code" mean? .....	238
How to solve the IP conflict problem? .....	238
How to reset the IP phone to factory configurations?.....	238
How to restore the administrator password? .....	239
What are the main differences between T28P, T26P, T22P and T20P? .....	239

## **Appendix .....241**

Appendix A: Glossary.....	241
Appendix B: Time Zones.....	243
Appendix C: Configuration Parameters .....	246
Setting Parameters in Configuration Files.....	246
Basic and Advanced Parameters.....	246
Audio Feature Parameters.....	354
Security Feature Parameters .....	362
Upgrading Firmware .....	366
Resource Files .....	371
Troubleshooting .....	375
Configuring DSS Key .....	376
DND Key .....	384
Appendix D: SIP (Session Initiation Protocol).....	396
RFC and Internet Draft Support .....	397
SIP Request.....	398
SIP Header .....	399
SIP Responses .....	400
SIP Session Description Protocol (SDP) Usage .....	403
Appendix E: SIP Call Flows.....	404
Successful Call Setup and Disconnect .....	405
Unsuccessful Call Setup—Called User is Busy .....	407
Unsuccessful Call Setup—Called User Does Not Answer .....	411
Successful Call Setup and Call Hold .....	414
Successful Call Setup and Call Waiting .....	416
Call Transfer without Consultation .....	421
Call Transfer with Consultation.....	425
Always Call Forward.....	431
Busy Call Forward .....	434
No Answer Call Forward .....	437

Call Conference.....	440
Appendix F: Sample Configuration File .....	445
<b>Index.....</b>	<b>451</b>

# Product Overview

---

This chapter contains the following information about IP phones:

- [VoIP Principle](#)
- [SIP Components](#)
- [SIP IP Phone Models](#)

## VoIP Principle

### VoIP

**VoIP** (Voice over Internet Protocol) is a technology using the Internet Protocol instead of traditional Public Switch Telephone Network (PSTN) technology for voice communications.

It is a family of technologies, methodologies, communication protocols, and transmission techniques for the delivery of voice communications and multimedia sessions over IP networks. The H.323 and Session Initiation Protocol (SIP) are two popular VoIP protocols that are found in widespread implement.

### H.323

**H.323** is a recommendation from the ITU Telecommunication Standardization Sector (ITU-T) that defines the protocols to provide audio-visual communication sessions on any packet network. The H.323 standard addresses call signaling and control, multimedia transport and control, and bandwidth control for point-to-point and multi-point conferences.

It is widely implemented by voice and video conference equipment manufacturers, is used within various Internet real-time applications such as GnuGK and NetMeeting and is widely deployed worldwide by service providers and enterprises for both voice and video services over IP networks.

### SIP

**SIP** (Session Initiation Protocol) is the Internet Engineering Task Force's (IETF's) standard for multimedia conferencing over IP. It is an ASCII-based, application-layer control protocol (defined in RFC 3261) that can be used to establish, maintain, and terminate calls between two or more endpoints. Like other VoIP protocols, SIP is designed to address functions of signaling and session management within a packet telephony network. Signaling allows call information to be carried across network boundaries. Session management provides the ability to control attributes of an end-to-end call.

SIP provides capabilities to:

- Determine the location of the target endpoint -- SIP supports address resolution, name mapping, and call redirection.
- Determine media capabilities of the target endpoint -- Via Session Description Protocol (SDP), SIP determines the "lowest level" of common services between endpoints. Conferences are established using only media capabilities that can be supported by all endpoints.
- Determine the availability of the target endpoint -- A call cannot be completed because the target endpoint is unavailable, SIP determines whether the called party is already on the IP phone or did not answer in the allotted number of rings. It then returns a message indicating why the target endpoint was unavailable.
- Establish a session between the origin and target endpoint -- The call can be completed, SIP establishes a session between endpoints. SIP also supports mid-call changes, such as the addition of another endpoint to the conference or the changing of a media characteristic or codec.
- Handle the transfer and termination of calls -- SIP supports the transfer of calls from one endpoint to another. During a call transfer, SIP simply establishes a session between the transferee and a new endpoint (specified by the transferring party) and terminates the session between the transferee and the transferring party. At the end of a call, SIP terminates the sessions between all parties.

## SIP Components

SIP is a peer-to-peer protocol. The peers in a session are called User Agents (UAs). A user agent can function as one of following roles:

- User Agent Client (UAC) -- A client application that initiates the SIP request.
- User Agent Server (UAS) -- A server application that contacts the user when a SIP request is received and that returns a response on behalf of the user.

### User Agent Client (UAC)

The UAC is an application that initiates up to six feasible SIP requests to the UAS. The six requests issued by the UAC are: INVITE, ACK, OPTIONS, BYE, CANCEL and REGISTER. When the SIP session is being initiated by the UAC SIP component, the UAC determines the information essential for the request, which is the protocol, the port and the IP address of the UAS to which the request is being sent. This information can be dynamic and this will make it challenging to put through a firewall. For this reason it may be recommended to open the specific application type on the firewall. The UAC is also capable of using the information in the request URI to establish the course of the SIP request to its destination, as the request URI always specifies the host which is essential. The port and protocol are not always specified by the request URI. Thus if the request does not specify a port or protocol, a default port or protocol is contacted. Using this

method may be the preferred measure when not using an application layer firewall, application layer firewalls like to know what applications are flowing through which ports and it is possible using content types of other applications other than the one you are trying to let through which has been denied.

## User agent server (UAS)

UAS is the server that hosts the application responsible for receiving SIP requests from a UAC, and on reception returns a response to the request back to the UAC. The UAS may issue multiple responses to the UAC, not necessarily a single response. Communication between UAC and UAS is client/server and peer-to-peer.

Typically, a SIP endpoint is capable of functioning as both a UAC and a UAS, but it functions only as one or the other per transaction. Whether the endpoint functions as a UAC or a UAS depends on the UA that initiates the request.

## SIP IP Phone Models

This section introduces SIP IP phones models. IP phones are endpoints in the overall network topology, which are designed to interoperate with other compatible equipments including application servers, media servers, internet-working gateways, voice bridges, and other endpoints. IP phones are characterized by a large number of functions, which simplify business communication with a high standard of security and can work seamlessly with a large number of SIP PBXs.

IP phones provide a powerful and flexible IP communication solution for Ethernet TCP/IP networks, delivering excellent voice quality. The high-resolution graphic display supplies content in multiple languages for system status, call history and directory access. IP phones also support advanced functionalities, including LDAP, Busy Lamp Field, Sever Redundancy and Network Conference.

The following IP phone models are described:

- SIPT28P
- SIPT26P
- SIPT22P
- SIPT21P
- SIPT20P
- SIPT19P

IP phones comply with the SIP standard (RFC 3261), and they can only be used within a network that supports this type of phone.

For successfully operating as SIP endpoints in your network, IP phones must meet the following requirements:

- A working IP network is established.

- Routers are configured for VoIP.
- VoIP gateways are configured for SIP.
- The latest (or compatible) firmware of IP phones is available.
- A call server is active and configured to receive and send SIP messages.

## Physical Features of IP Phones

This section lists the available physical features of IP phones.

### SIP-T28P



#### Physical Features:

- TI TITAN chipset and TI voice engine
- 320x160 graphic LCD with 4-level grayscales
- 6 VoIP accounts, BroadSoft/Avaya/Asterisk validated
- HD Voice: HD Codec, HD Handset, HD Speaker
- 48 keys including 16 DSS keys
- 1xRJ9 (4P4C) handset port
- 1xRJ9 (4P4C) headset port
- 2xRJ45 10/100M Ethernet ports
- 1XRJ12 (6P6C) expansion module port
- 19 LEDs: 1xpower, 6xline, 1xmessage, 1xheadset, 10xmemory
- Power adapter: AC 100~240V input and DC 5V/1.2A output
- Power over Ethernet (IEEE 802.3af)



## SIPT26P



### Physical Features:

- TI TITAN chipset and TI voice engine
- 132x64 graphic LCD
- 3 VoIP accounts, BroadSoft/Avaya/Asterisk validated
- HD Voice: HD Codec, HD Handset, HD Speaker
- 45 keys including 13 DSS keys
- 1xRJ9 (4P4C) handset port
- 1xRJ9 (4P4C) headset port
- 2xRJ45 10/100M Ethernet ports
- 1XRJ12 (6P6C) expansion module port
- 16 LEDs: 1xpower, 3xline, 1xmessage, 1xheadset, 10xmemory
- Power adapter: AC 100~240V input and DC 5V/1.2A output
- Power over Ethernet (IEEE 802.3af)

## SIP-T22P



### Physical Features:

- TI TITAN chipset and TI voice engine
- 132x64 graphic LCD
- 3 VoIP accounts, BroadSoft/Avaya/Asterisk validated
- HD Voice: HD Codec, HD Handset, HD Speaker
- 32 keys including 4 soft keys
- 1xRJ9 (4P4C) handset port
- 1xRJ9 (4P4C) headset port
- 2xRJ45 10/100M Ethernet ports
- 5 LEDs: 1xpower, 3xline, 1xmessage
- Power adapter: AC 100~240V input and DC 5V/1.2A output
- Power over Ethernet (IEEE 802.3af)
- Wall Mount

## SIPT21P



### Physical Features:

- 132x64 graphic LCD
- 2 VoIP accounts
- 31 keys including 4 soft keys
- 4 LEDs: 1xpower, 2xline, 1xmessage
- HD Voice: HD Codec, HD Handset, HD Speaker
- 1xRJ9 (4P4C) handset port
- 1xRJ9 (4P4C) headset port
- 2xRJ45 10/100M Ethernet ports
- Power adapter: AC 100~240V input and DC 5V/1.2A output
- Power over Ethernet (IEEE 802.3af)
- Wall Mount

## SIP-T20P



### Physical Features:

- TI TITAN chipset and TI voice engine
- 3-line LCD consists of an icon line and two 15-character lines
- 2 VoIP accounts, BroadSoft/Avaya/Asterisk validated
- HD Voice: HD Codec, HD Handset, HD Speaker
- 31 keys including 9 function keys
- 1xRJ9 (4P4C) handset port
- 1xRJ9 (4P4C) headset port
- 2xRJ45 10/100M Ethernet ports
- 4 LEDs: 1xpower, 2xline, 1xmessage
- Power adapter: AC 100~240V input and DC 5V/1.2A output
- Power over Ethernet (IEEE 802.3af)
- Wall Mount

## SIPT19P



### Physical Features:

- 132x64 graphic LCD
- Single VoIP account
- 29 keys including 4 soft keys
- 1xRJ9 (4P4C) handset port
- 1xRJ9 (4P4C) headset port
- 2xRJ45 10/100M Ethernet ports
- 1 LED: 1xpower
- Power adapter: AC 100~240V input and DC 5V/800mA output
- Power over Ethernet (IEEE 802.3af)
- Wall Mount

## Key Features of IP Phones

In addition to physical features introduced above, IP phones also support the following key features when running the latest firmware:

- **Phone Features**
  - **Call Options:** emergency call, call waiting, call hold, call mute, call forward, call transfer, call pickup, 3-way local conference.
  - **Basic Features:** DND, phone lock, auto redial, live dialpad, dial plan, hotline, caller identity, auto answer.
  - **Advanced Features:** BLF (not applicable to the SIP-T19P IP phone), server redundancy, distinctive ring tones, remote phone book, SNMP, LDAP (not applicable to the SIP-T19P IP phone), 802.1x authentication.
- **Codecs and Voice Features**
  - Wideband Codec: G.722
  - Narrowband codec: G.711, G.723, G.726, G.729AB, iLBC
  - VAD, CNG, AEC, PLC, AJB, AGC
  - Full-duplex speakerphone with AEC
- **Network Features**
  - SIP v1 (RFC2543), v2 (RFC3261)
  - NAT Traversal: STUN mode
  - DTMF: INBAND, RFC2833, SIP INFO
  - Proxy mode and peer-to-peer SIP link mode
  - IP assignment: Static/DHCP/PPPoE
  - VLAN assignment: LLDP/Static/DHCP
  - Bridge/Router (not applicable to the SIP-T19P IP phone) mode for PC port
  - TFTP/DHCP/PPPoE client
  - HTTP/HTTPS server
  - DNS client
  - NAT/DHCP server
  - IPv6 support
- **Management**
  - FTP/TFTP/HTTP/PnP auto-provision
  - Configuration: browser/phone/auto-provision
  - Direct IP call without SIP proxy
  - Dial number via SIP server
  - Dial URL via SIP server

- TR-069
- **Security**
  - HTTPS (server/client)
  - SRTP (RFC3711)
  - Transport Layer Security (TLS)
  - VLAN (802.1q), QoS
  - Digest authentication using MD5/MD5-sess
  - Secure configuration file via AES encryption
  - Phone lock for personal privacy protection
  - Admin/User configuration mode





# Getting Started

---

This chapter provides basic information and installation instructions of IP phones.

This chapter provides the following sections:

- [Connecting the IP Phones](#)
- [Initialization Process Overview](#)
- [Verifying Startup](#)
- [Configuration Methods](#)
- [Reading Icons](#)
- [Configuring Basic Network Parameters](#)
- [Creating Dial Plan](#)

## Connecting the IP Phones

This section introduces how to install IP phones with components in packaging contents.

1. Attach the stand
2. Connect the handset and optional headset
3. Connect the network and power

**Note** A headset is not included in packaging contents.

1) Attach the stand:

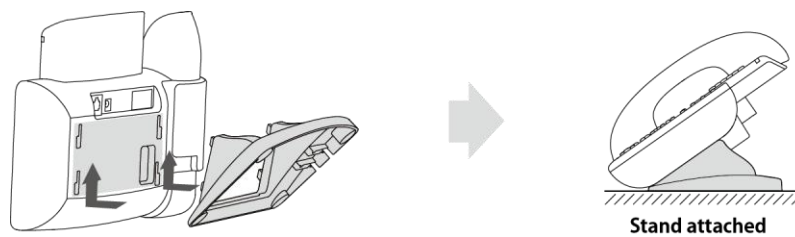

SIP-T28P/T26P

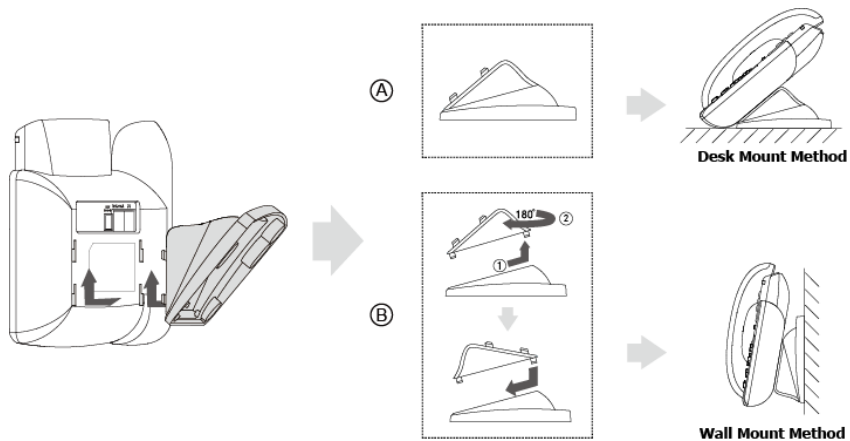

SIP-T22P/T21P/T20P

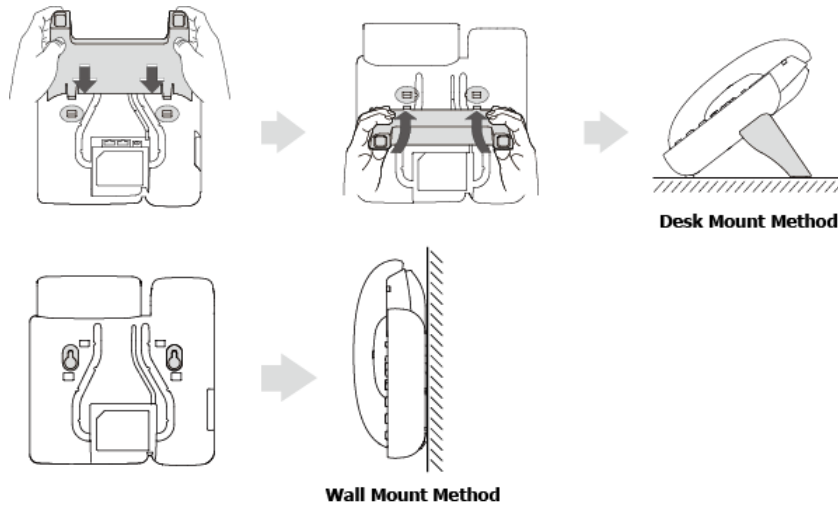

SIP-T19P

2) **Connect the handset and optional headset:**

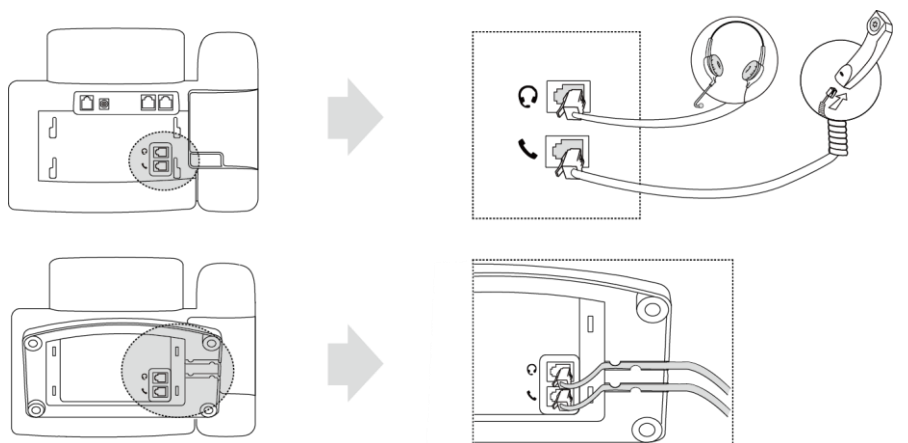

SIP-T28P/T26P

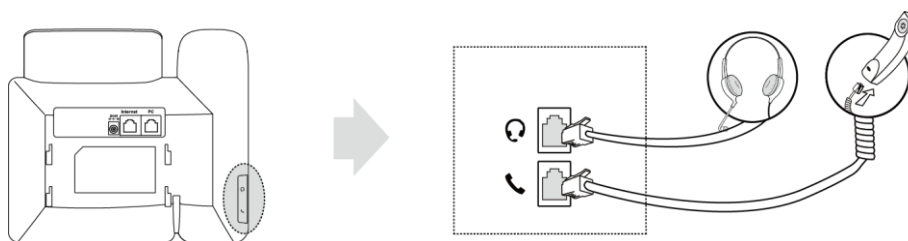

SIP-T22P/T21P/T20P/T19P

3) **Connect the network and power:**

- AC power
- Power over Ethernet (PoE)

**AC Power**

**To connect the AC power and network:**

1. Connect the DC plug of the power adapter to the DC5V port on the IP phone and connect the other end of the power adapter into an electrical power outlet.

2. Connect the included or a standard Ethernet cable between the Internet port on the IP phone and the one on the wall or switch/hub device port.

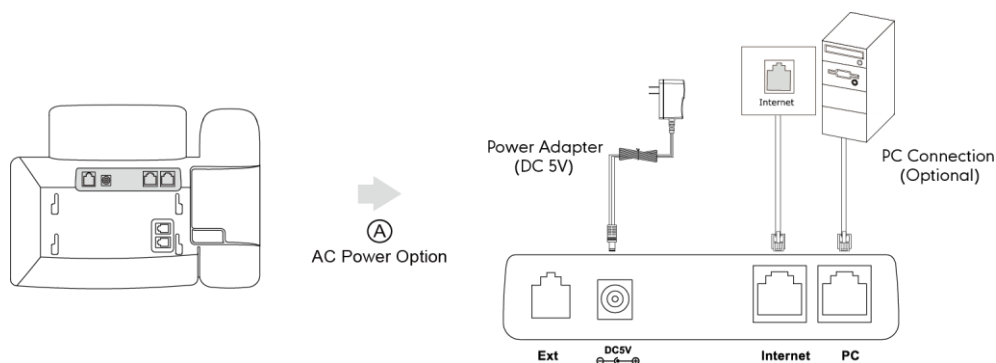

### Power over Ethernet

With the included or a regular Ethernet cable, IP phones can be powered from a PoE-compliant switch or hub.

#### To connect the PoE:

1. Connect the Ethernet cable between the Internet port on the IP phone and an available port on the in-line power switch/hub.

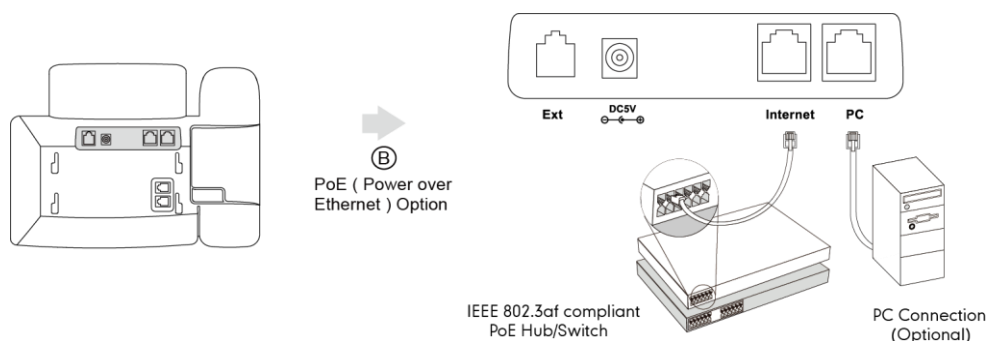

#### Note

If in-line power switch/hub is provided, you don't need to connect the phone to the power adapter. Make sure the switch/hub is PoE-compliant.

The IP phone can also share the network with another network device such as a PC (personal computer). It is an optional connection.

**Important!** Do not unplug or remove power while the IP phone is updating firmware and configurations.

## Initialization Process Overview

The initialization process of the IP phone is responsible for network connectivity and operation of the IP phone in your local network.

Once you connect your IP phone to the network and to an electrical supply, the IP phone begins its initialization process.

During the initialization process, the following events take place:

### **Loading the ROM file**

The ROM file resides in the flash memory of the IP phone. The IP phone come from the factory with a ROM file preloaded. During initialization, the IP phone runs a bootstrap loader that loads and executes the ROM file.

### **Configuring the VLAN**

If the IP phone is connected to a switch, the switch notifies the IP phone of the VLAN information defined on the switch (if using LLDP). The IP phone can then proceed with the DHCP request for its network settings (if using DHCP).

### **Querying the DHCP (Dynamic Host Configuration Protocol) Server**

The IP phone is capable of querying a DHCP server. DHCP is enabled on the IP phone by default. The following network parameters can be obtained from the DHCP server during initialization:

- IP Address
- Subnet Mask
- Gateway
- Primary DNS (Domain Name Server)
- Secondary DNS

You need to configure network parameters of the IP phone manually if any of them is not supplied by the DHCP server. For more information on configuring network parameters manually, refer to [Configuring Network Parameters Manually](#) on page 24.

### **Contacting the provisioning server**

If the IP phone is configured to obtain configurations from the provisioning server, it will connect to the provisioning server and download the configuration file(s) during startup. The IP phone will be able to resolve and update configurations written in the configuration file(s). If the IP phone does not obtain configurations from the provisioning server, the IP phone will use configurations stored in the flash memory.

### **Updating firmware**

If the access URL of firmware is defined in the configuration file, the IP phone will download firmware from the provisioning server. If the MD5 value of the downloaded firmware file differs from that of the image stored in the flash memory, the IP phone performs a firmware update.

### **Downloading the resource files**

In addition to configuration file(s), the IP phone may require resource files before it can deliver service. These resource files are optional, but if some particular features are being deployed, these files are required.

The followings show examples of resource files:

- Language packs
- Ring tones
- Contact files

## Verifying Startup

After connected to the power and network, the IP phone begins the initializing process by cycling through the following steps:

1. The power indicator LED illuminates.
2. The message "Initializing, Please wait" appears on the LCD screen as the IP phone starts up.
3. The main LCD screen displays the following:
  - Time and date
  - Soft key labels (not applicable to the SIP-T20P IP phone)
4. Press the OK key to check the IP phone status, the LCD screen displays the valid IP address, MAC address, firmware version, etc.

If the IP phone has successfully passed through these steps, it starts up properly and is ready for use.

## Configuration Methods

You can use the following methods to set up and configure IP phones:

- [Phone User Interface](#)
- [Web User Interface](#)
- [Configuration Files](#)

The following sections describe how to configure IP phones using each method above.

### Phone User Interface

An administrator or a user can configure and use IP phones via phone user interface. Access to specific features is restricted to the administrator. The default password is "admin"(case-sensitive). Not all features are available on phone user interface.

### Web User Interface

An administrator or a user can configure IP phones via web user interface. The default user name and password for the administrator to log into the web user interface are

both “admin” (case-sensitive). Almost all features are available on web user interface. IP phones support both HTTP and HTTPS protocols for accessing the web user interface. For more information, refer to [Web Server Type](#) on page 115.

## Configuration Files

You can deploy IP phones using configuration files. There are two configuration files both of which are CFG formatted. We call them Common CFG file and MAC-Oriented CFG file. A Common CFG file will be effectual for all IP phones of the same model. However, a MAC-Oriented CFG file will only be effectual for a specific IP phone. The Common CFG file has a fixed name for each IP phone model, while the MAC-Oriented CFG file is named after the MAC address of the IP phone. For example, if the MAC address of a SIP-T22P IP phone is 001565113af8, names of these two configuration files must be: y000000000005.cfg and 001565113af8.cfg.

The name of the Common CFG file for each IP phone model is:

- SIP-T28P: y000000000000.cfg
- SIP-T26P: y000000000004.cfg
- SIP-T22P: y000000000005.cfg
- SIP-T21P: y000000000034.cfg
- SIP-T20P: y000000000007.cfg
- SIP-T19P: y000000000031.cfg

In order to deploy IP phones using the configuration files (<y0000000000xx>.cfg and <MAC>.cfg), you need to use a text-based editing application to edit configuration files, and store configuration files to a provisioning server. IP phones support downloading configuration files using any of the following protocols: FTP, TFTP, HTTP and HTTPS.

IP phones can obtain the address of the provisioning server during startup through one of the following processes: Zero Touch, PnP, DHCP Options and Phone Flash. Then IP phones download configuration files from the provisioning server, resolve and update the configurations written in configuration files. This entire process is called auto provisioning. For more information on auto provisioning, refer to *Yealink SIP-T2 Series/T3 Series/T19P/VP530 IP Phones Auto Provisioning Guide*.

### When modifying parameters, learn the following:

- Parameters in configuration files override those stored in the IP phone’s flash memory.
- The .cfg extension of configuration files must be in lowercase.

- Each line in a configuration file must use the following format and adhere to the following rules:

variable-name = value

- Associate only one value with one variable.
- Separate variable name and value with equal sign.
- Set only one variable per line.
- Put the variable and value on the same line, and do not break the line.
- Comment the variable on a separated line. Use the pound (#) delimiter to distinguish the comments.













































IP phones can accept two sources of configuration data:

- Downloaded from configuration files
- Changed on the phone user interface or the web user interface

















































































The latest values configured on the IP phone take effect finally.

## Reading Icons

Icons associated with different features may appear on the LCD screen. The following table provides a description for each icon on IP phones.

SIP-T28P	SIP-T26P	SIP-T22P	SIP-T21P	SIP-T20P	SIP-T19P	Description
						Network is unavailable
				/		Registered successfully
				/		Registration failed
				/		Registering
						Hands-free speakerphone mode
						Handset mode
						Headset mode
						Voice Mail



SIP-T28P	SIP-T26P	SIP-T22P	SIP-T21P	SIP-T20P	SIPT19P	Description
				/		Text Message
				<b>AA</b>		Auto Answer
				<b>DND</b>		Do Not Disturb
						Call Forward/Forwarded Calls
				/		Call Hold
						Call Mute
				/		Ringer volume is 0
						Phone Lock
						Received Calls
						Placed Calls
						Missed Calls
				/	/	Recording box is full
				/	/	A call cannot be recorded
				/	/	Recording starts successfully
				/	/	Recording cannot be started
				/	/	Recording cannot be stopped

## Configuring Basic Network Parameters

This section describes how to configure basic network parameters for the IP phone.

**Note** This section mainly introduces IPv4 network parameter. IP phones also support IPv6. For more information on IPv6, refer to [IPv6 Support](#) on page 190.

### DHCP

DHCP (Dynamic Host Configuration Protocol) is a network protocol used to dynamically allocate network parameters to network hosts. The automatic allocation of network parameters to hosts eases the administrative burden of maintaining an IP network. IP phones comply with the DHCP specifications documented in RFC 2131. If using DHCP, IP phones connected to the network become operational without having to be manually assigned IP addresses and additional network parameters. DHCP is enabled on IP phones by default.

#### DHCP Option

DHCP provides a framework for passing information to TCP/IP network devices. Network and other control information are carried in tagged data items that are stored in the options field of the DHCP message. The data items themselves are also called options. DHCP can be initiated by simply connecting the IP phone with the network. IP phones broadcast DISCOVER messages to request the network information carried in DHCP options, and the DHCP server responds with specific values in corresponding options.

The following table lists common DHCP options supported by IP phones.

Parameter	DHCP Option	Description
Subnet Mask	1	Specify the client's subnet mask.
Time Offset	2	Specify the offset of the client's subnet in seconds from Coordinated Universal Time (UTC).
Router	3	Specify a list of IP addresses for routers on the client's subnet.
Time Server	4	Specify a list of time servers available to the client.
Domain Name Server	6	Specify a list of domain name servers available to the client.
Log Server	7	Specify a list of MIT-LCS UDP servers available to the client.

Parameter	DHCP Option	Description
Host Name	12	Specify the name of the client.
Domain Server	15	Specify the domain name that client should use when resolving hostnames via DNS.
Broadcast Address	28	Specify the broadcast address in use on the client's subnet.
Network Time Protocol Servers	42	Specify a list of NTP servers available to the client by IP address.
Vendor-Specific Information	43	Identify the vendor-specific information.
Vendor Class Identifier	60	Identify the vendor type.
TFTP Server Name	66	Identify a TFTP server when the 'sname' field in the DHCP header has been used for DHCP options.
Boot file Name	67	Identify a boot file when the 'file' field in the DHCP header has been used for DHCP options.

## Procedure

DHCP can be configured using the configuration files or locally.

<b>Configuration File</b>	<y0000000000xx>.cfg	Configure DHCP on the IP phone. For more information, refer to <a href="#">DHCP</a> on page 246.
<b>Local</b>	Web User Interface	Configure DHCP on the IP phone. <b>Navigate to:</b> http://<phoneIPAddress>/servlet?p=network&q=load
	Phone User Interface	Configure DHCP on the IP phone.

**To configure DHCP via web user interface:**

1. Click on **Network->Basic**.

- In the **IPv4 Config** block, mark the **DHCP** radio box.

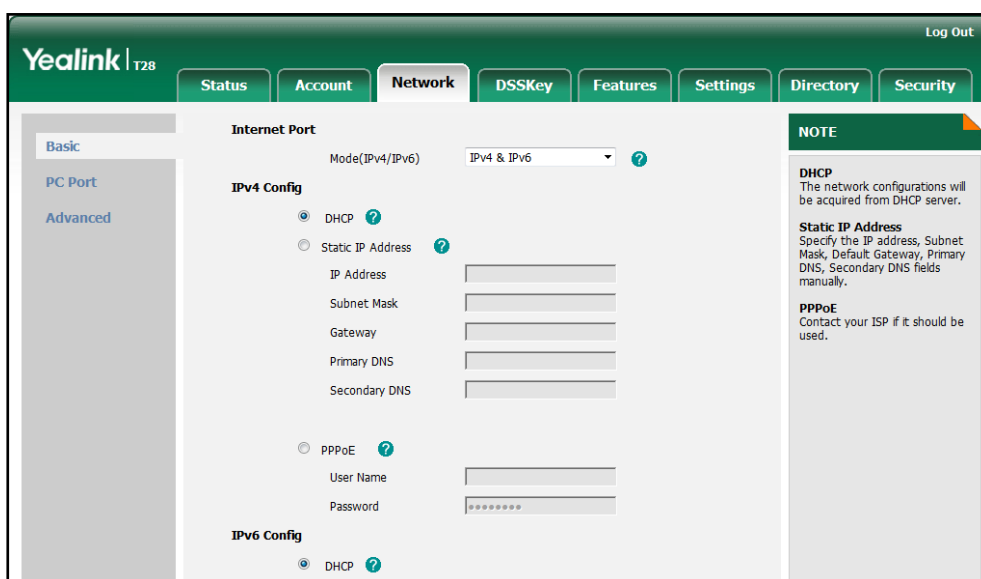

- Click **Confirm** to accept the change.  
A dialog box pops up to prompt that settings will take effect after reboot.
- Click **OK** to reboot the IP phone.

**To configure DHCP via phone user interface:**

- Press **Menu->Settings->Advanced Settings** (password: admin) ->**Network->WAN Port->IPv4**.
- Press **▲** or **▼** to highlight the **DHCP IP Client** field.
- Press the **Save** soft key to accept the change.

The IP phone reboots automatically to make settings effective after a period of time.

## Configuring Network Parameters Manually

If DHCP is disabled or IP phones cannot obtain network parameters from the DHCP server, you need to configure them manually. The following parameters should be configured for IP phones to establish network connectivity:

- IP Address
- Subnet Mask
- Default Gateway
- Primary DNS
- Secondary DNS

## Procedure

Network parameters can be configured manually using the configuration files or locally.

<b>Configuration File</b>	<y0000000000xx>.cfg	Configure network parameters of the IP phone manually. For more information, refer to <a href="#">Static Network Settings</a> on page 247.
<b>Local</b>	Web User Interface	Configure network parameters of the IP phone manually. <b>Navigate to:</b> http://<phoneIPAddress>/servlet?p=network&q=load
	Phone User Interface	Configure network parameters of the IP phone manually.

To configure the IP address mode via web user interface:

1. Click on **Network->Basic**.
2. Select desired value from the pull-down list of **Mode (IPv4/IPv6)**.

The screenshot shows the Yealink T28 web interface. The 'Network' tab is selected, and the 'Basic' sub-tab is active. The 'Internet Port' section is expanded, showing a dropdown menu for 'Mode(IPv4/IPv6)' set to 'IPv4 & IPv6'. Below this, the 'IPv4 Config' section has the 'DHCP' radio button selected. The 'IPv6 Config' section also has the 'DHCP' radio button selected. On the right side, there is a 'NOTE' box with the following text:

**NOTE**

**DHCP**  
The network configurations will be acquired from DHCP server.

**Static IP Address**  
Specify the IP address, Subnet Mask, Default Gateway, Primary DNS, Secondary DNS fields manually.

**PPPoE**  
Contact your ISP if it should be used.

3. Click **Confirm** to accept the change.  
A dialog box pops up to prompt that settings will take effect after reboot.
4. Click **OK** to reboot the IP phone.

To configure a static IPv4 address via web user interface:

1. Click on **Network->Basic**.
2. In the **IPv4 Config** block, mark the **Static IP Address** radio box.

3. Enter the desired values in the **IP Address**, **Subnet Mask**, **Gateway**, **Primary DNS** and **Secondary DNS** fields.

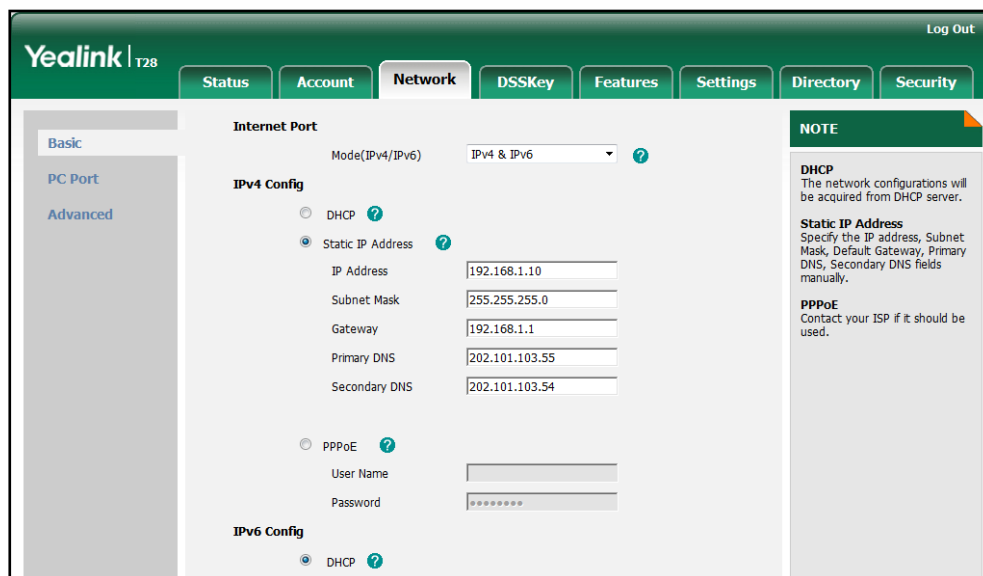

4. Click **Confirm** to accept the change.  
A dialog box pops up to prompt that settings will take effect after reboot.
5. Click **OK** to reboot the IP phone.

**To configure the IP address mode via phone user interface:**

1. Press **Menu->Settings->Advanced Settings** (password: admin) -> **Network->WAN Port**.
2. Press **◀** or **▶** to select **IPv4**, **IPv6** or **IPv4&IPv6** from the **IP Mode** field.
3. Press the **Save** soft key to accept the change.

The IP phone reboots automatically to make settings effective after a period of time.

**To configure a static IPv4 address via phone user interface:**

1. Press **Menu->Settings->Advanced Settings** (password: admin) -> **Network->WAN Port->IPv4->Static IP Client**.
2. Enter the desired values in the **IPv4**, **Subnet Mask**, **Default Gateway**, **Pri DNS** and **Sec DNS** fields.
3. Press the **Save** soft key to accept the change.

The IP phone reboots automatically to make settings effective after a period of time.

**Note**

Using the wrong network parameters may result in inaccessibility of your phone and may also have an impact on your network performance. For more information on these parameters, contact your network administrator.

## PPPoE

PPPoE (Point-to-Point Protocol over Ethernet) is a network protocol used by Internet Service Providers (ISPs) to provide Digital Subscriber Line (DSL) high speed Internet services. PPPoE allows an office or building-full of users to share a common DSL connection to the Internet. PPPoE connection is supported by the IP phone Internet port. Contact your ISP for the PPPoE user name and password.

### Procedure

PPPoE can be configured using the configuration files or locally.

<b>Configuration File</b>	<y0000000000xx>.cfg	Configure PPPoE on the IP phone. For more information, refer to <a href="#">PPPoE</a> on page 250.
<b>Local</b>	Web User Interface	Configure PPPoE on the IP phone. <b>Navigate to:</b> http://<phoneIPAddress>/servlet ?p=network&q=load
	Phone User Interface	Configure PPPoE on the IP phone.

To configure PPPoE via web user interface:

1. Click on **Network->Basic**.
2. In the **IPv4 Config** block, mark the **PPPoE** radio box.
3. Enter the user name and password in corresponding fields.

The screenshot shows the Yealink T28 web interface. The 'Network' tab is active, and the 'Basic' sub-tab is selected. Under 'Internet Port', the 'Mode(IPv4/IPv6)' is set to 'IPv4 & IPv6'. In the 'IPv4 Config' section, the 'PPPoE' radio button is selected. The 'User Name' field is filled with 'Xmy0592123' and the 'Password' field is masked with dots. The 'IPv6 Config' section has 'DHCP' selected. A 'NOTE' box on the right contains the following text:

**NOTE**

**DHCP**  
The network configurations will be acquired from DHCP server.

**Static IP Address**  
Specify the IP address, Subnet Mask, Default Gateway, Primary DNS, Secondary DNS fields manually.

**PPPoE**  
Contact your ISP if it should be used.

4. Click **Confirm** to accept the change.

A dialog box pops up to prompt that settings will take effect after reboot.

5. Click **OK** to reboot the IP phone.

**To configure PPPoE via phone user interface:**

1. Press **Menu->Settings->Advanced Settings** (password: admin) ->**Network->WAN Port->IPv4->PPPoE IP Client**.
2. Enter the user name and password in corresponding fields.
3. Press the **Save** soft key to accept the change.

The IP phone reboots automatically to make settings effective after a period of time.

## Configuring Transmission Methods of the Internet Port and PC

### Port

Two Ethernet ports on the back of the IP phone: Internet port and PC port. Three optional methods of transmission configuration for IP phone Internet or PC Ethernet ports:

- Auto-negotiation
- Half-duplex
- Full-duplex

Auto-negotiation is configured for both Internet and PC ports on the IP phone by default.

#### Auto-negotiation

Auto-negotiation means that two connected devices choose common transmission parameters (e.g., speed and duplex mode) to transmit voice or data over Ethernet. This process entails devices first sharing transmission capabilities and then selecting the highest performance transmission mode supported by both. You can configure the Internet port and PC port on the IP phone to automatically negotiate during the transmission.



## Half-duplex

Half-duplex transmission refers to transmitting voice or data in both directions, but in one direction at a time; this means one device can send data on the line, but not receive data simultaneously. You can configure the half-duplex transmission on both Internet port and PC port for the IP phone to transmit in 10Mbps or 100Mbps.

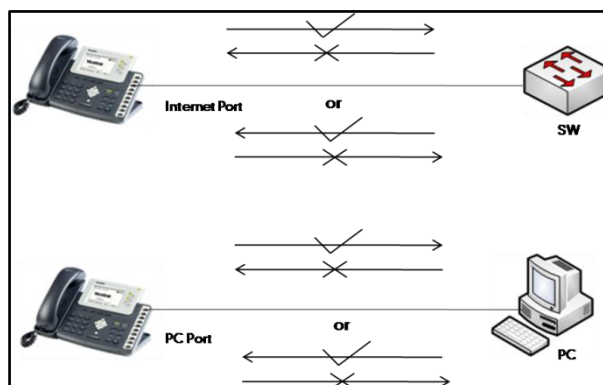

## Full-duplex

Full-duplex transmission refers to transmitting voice or data in both directions at the same time; this means one device can send data on the line while receiving data. You can configure the full-duplex transmission on both Internet port and PC port for the IP phone to transmit in 10Mbps or 100Mbps.

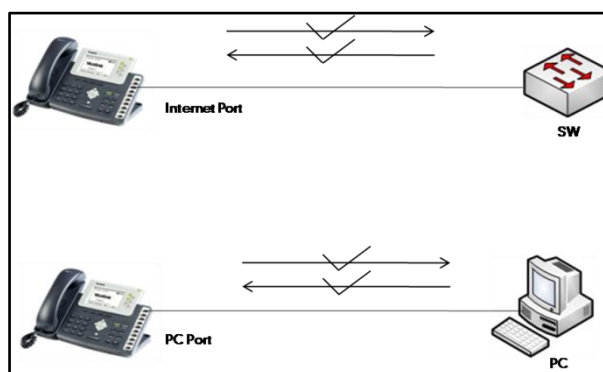

## Procedure

The transmission methods of Ethernet ports can be configured using the configuration files or locally.

<b>Configuration File</b>	<y0000000000xx>.cfg	Configure the transmission methods of Ethernet ports. For more information, refer to <a href="#">Internet and PC Ports Transmission Methods</a> on page 251.
---------------------------	---------------------	---

Local	Web User Interface	<p>Configure the transmission methods of Ethernet ports.</p> <p><b>Navigate to:</b></p> <p>http://&lt;phoneIPAddress&gt;/servlet?p=network-adv&amp;q=load</p>
-------	--------------------	---

To configure the transmission methods of Ethernet ports via web user interface:

1. Click on **Network->Advanced**.
2. Select the desired value from the pull-down list of **WAN Port Link**.
3. Select the desired value from the pull-down list of **PC Port Link**.

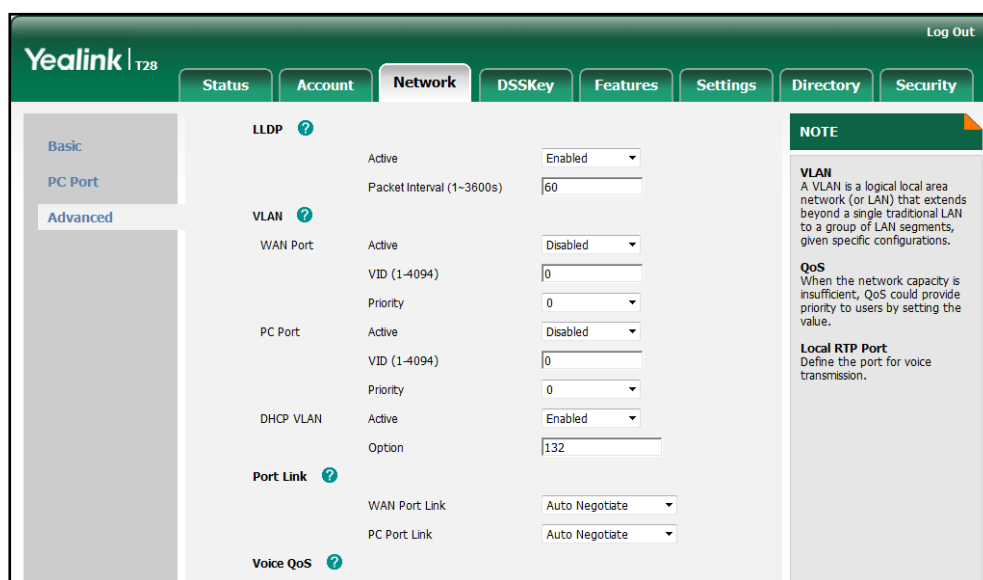

4. Click **Confirm** to accept the change.

## Configuring PC Port Mode

The PC port on the back of the IP phone is used to connect a PC, which can be configured in one of two modes:

- **Bridge:** The IP phone functions as a bridge, and the connected PC appears on the network as a stand-alone device with its own IP address.
- **Router:** The IP phone functions as a router, and provides a DHCP service to connected PC.

### Note

The router mode is not applicable to SIP-T19P and SIP-T21P IP phones.

## Procedure

PC port mode can be configured using the configuration files or locally.

<b>Configuration File</b>	<y0000000000xx>.cfg	Configure the PC port mode. For more information, refer to <a href="#">PC Port Mode</a> on page 252.
<b>Local</b>	Web User Interface	Configure the PC port mode. <b>Navigate to:</b> http://<phoneIPAddress>/servlet ?p=network-pcport&q=load
	Phone User Interface	Configure the PC port mode.

**To configure the PC port mode via web user interface:**

1. Click on **Network->PC Port**.
2. Select the desired value from the pull-down list of **PC Port Active**.
3. Mark the desired radio box.

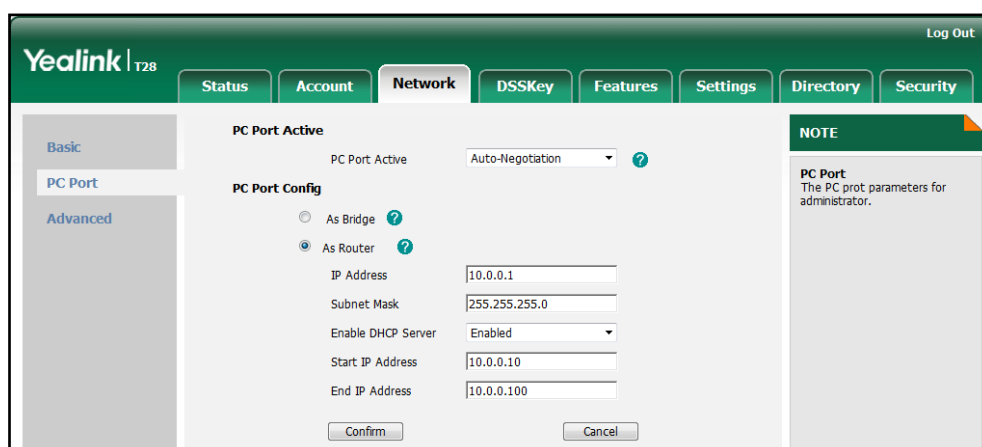

If you mark the **As Router** radio box, you can configure the IP address for the PC port and configure DHCP for the PC attached to the PC port (not applicable to SIP-T19P and SIP-T21P IP phones).

- 1) Enter the IP address in the **IP Address** field.
- 2) Enter subnet mask in the **Subnet Mask** field.
- 3) Select the desired value from the pull-down list of **Enable DHCP Server**.
- 4) Enter the start IP address in the **Start IP Address** field.
- 5) Enter the end IP address in the **End IP Address** field.



4. Click **Confirm** to accept the change.  
A dialog box pops up to prompt that settings will take effect after reboot.
5. Click **OK** to reboot the IP phone.

**To configure the PC port mode via phone user interface:**

1. Press **Menu->Settings->Advanced Settings** (password: admin) ->**Network->PC Port**.
2. Select the desired mode.  
 If you select **Router**, you can configure the IP address for the PC port and configure DHCP for the PC attached to the PC port (not applicable to SIP-T19P and SIP-T21P IP phones).
  - 1) Enter the IP address in the **IPv4** field.
  - 2) Enter the subnet mask in the **Subnet Mask** field.
  - 3) Press  or  to highlight the **DHCP Server** field, and then press the **Enter** soft key.
  - 4) Select the desired value from the **Server Status** field.
  - 5) Enter the start IP address in the **Start IP** field.
  - 6) Enter the end IP address in the **End IP** field.
3. Press the **Save** soft key to accept the change.  
 The IP phone reboots automatically to make settings effective after a period of time.

## Creating Dial Plan

Regular expression, often called a pattern, is an expression that specifies a set of strings. A regular expression provides a concise and flexible means to “match” (specify and recognize) strings of text, such as particular characters, words, or patterns of characters. Regular expression is used by many text editors, utilities, and programming languages to search and manipulate text based on patterns.

Regular expression can be used to define IP phone dial plan. Dial plan is a string of characters that governs the way for IP phones processing the inputs received from the IP phone keypads. IP phones support the following dial plan features:

- [Replace Rule](#)
- [Dial-now](#)
- [Area Code](#)
- [Block Out](#)

You need to know the following basic regular expression syntax when creating dial plan:

.	The dot “.” can be used as a placeholder or multiple placeholders for any string. Example: “12.” would match “123”, “1234”, “12345”, “12abc”, etc.
x	The “x” can be used as a placeholder for any character. Example:

	"12x" would match "121", "122", "123", "12a", etc.
-	The dash "-" can be used to match a range of characters within the brackets. Example: "[5-7]" would match the number "5", "6" or "7".
,	The comma "," can be used as a separator within the bracket. Example: "[2,5,8]" would match the number "2", "5" or "8".
[]	The square bracket "[]" can be used as a placeholder for a single character which matches any of a set of characters. Example: "91[5-7]1234" would match "9151234", "9161234", "9171234".
()	The parenthesis "(" )" can be used to group together patterns, for instance, to logically combine two or more patterns. Example: "([1-9])([2-7])3" would match "923", "153", "673", etc.
\$	The "\$" followed by the sequence number of a parenthesis means the characters placed in the parenthesis. The sequence number stands for the corresponding parenthesis. Example: A replace rule configuration, Prefix: "001(xxx)45(xx)", Replace: "9001\$145\$2". When you dial out "0012354599" on your phone, the IP phone will replace the number with "90012354599". "\$1" means 3 digits in the first parenthesis, that is, "235". "\$2" means 2 digits in the second parenthesis, that is, "99".

## Replace Rule

Replace rule is an alternative string that replaces the numbers entered by the user. IP phones support up to 100 replace rules, which can be created either one by one or in batch using a replace rule template. For more information on the replace rule template, refer to [Replace Rule Template](#) on page 221.

### Procedure

Replace rule can be created using the configuration files or locally.

<b>Configuration File</b>	<y0000000000xx>.cfg	Create the replace rule for the IP phone. For more information, refer to <a href="#">Dial Plan</a> on page 255.
<b>Local</b>	Web User Interface	Create the replace rule for the IP phone. <b>Navigate to:</b> http://<phoneIPAddress>/servlet

		?p=settings-dialplan&q=load
--	--	-----------------------------

To create a replace rule via web user interface:

1. Click on **Settings->Dial Plan->Replace Rule**.
2. Enter the string in the **Prefix** field.
3. Enter the string in the **Replace** field.
4. Enter the desired line ID in the **Account** field or leave it blank.

If you leave this field blank or enter 0, the replace rule applies to all accounts on the IP phone.

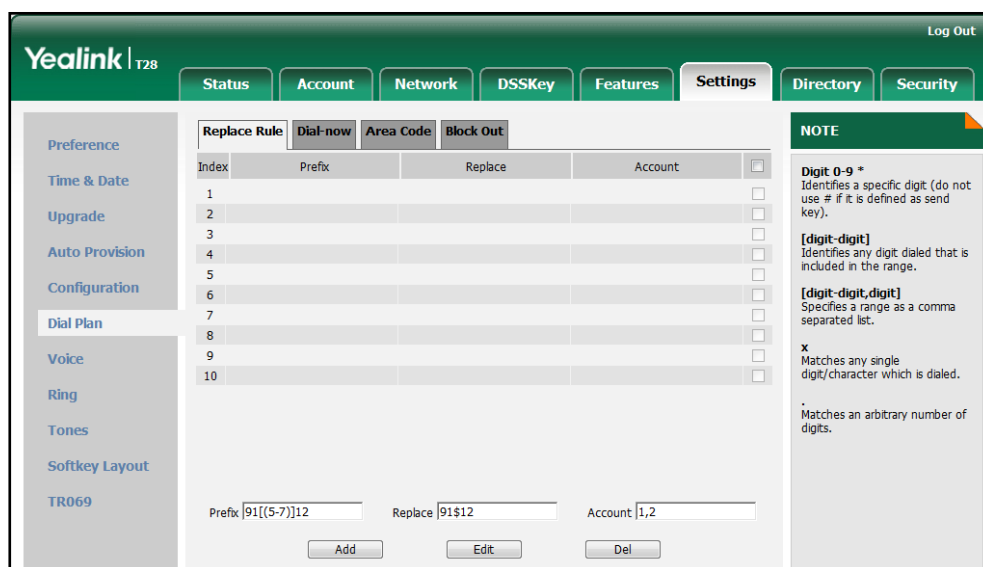

5. Click **Add** to add the replace rule.

## Dial-now

Dial-now is a string used to match numbers entered by the user. When entered numbers match the predefined dial-now rule, the IP phone will automatically dial out the numbers without employing the send key. IP phones support up to 100 dial-now rules, which can be created either one by one or in batch using a dial-now rule template. For more information on the dial-now template, refer to [Dial-now Template](#) on page 222.

### Delay Time for Dial-now Rule

The IP phone will automatically dial out the entered number, which matches the dial-now rule, after a specified period of time.

## Procedure

Dial-now rule can be created using the configuration files or locally.

<b>Configuration File</b>	<y0000000000xx>.cfg	<p>Create the dial-now rule for the IP phone.</p> <p>Configure the delay time for the dial-now rule.</p> <p>For more information, refer to <a href="#">Dial Plan</a> on page 255.</p>
<b>Local</b>	Web User Interface	<p>Create the dial-now rule for the IP phone.</p> <p><b>Navigate to:</b></p> <p>http://&lt;phoneIPAddress&gt;/servlet?p=settings-dialnow&amp;q=load</p> <p>Configure the delay time for the dial-now rule.</p> <p><b>Navigate to:</b></p> <p>http://&lt;phoneIPAddress&gt;/servlet?p=features-general&amp;q=load</p>

**To create a dial-now rule via web user interface:**

1. Click on **Settings->Dial Plan->Dial-now**.
2. Enter the desired value in the **Rule** field.
3. Enter the desired line ID in the **Account** field or leave it blank.

If you leave this field blank or enter 0, the dial-now rule applies to all accounts on the IP phone.

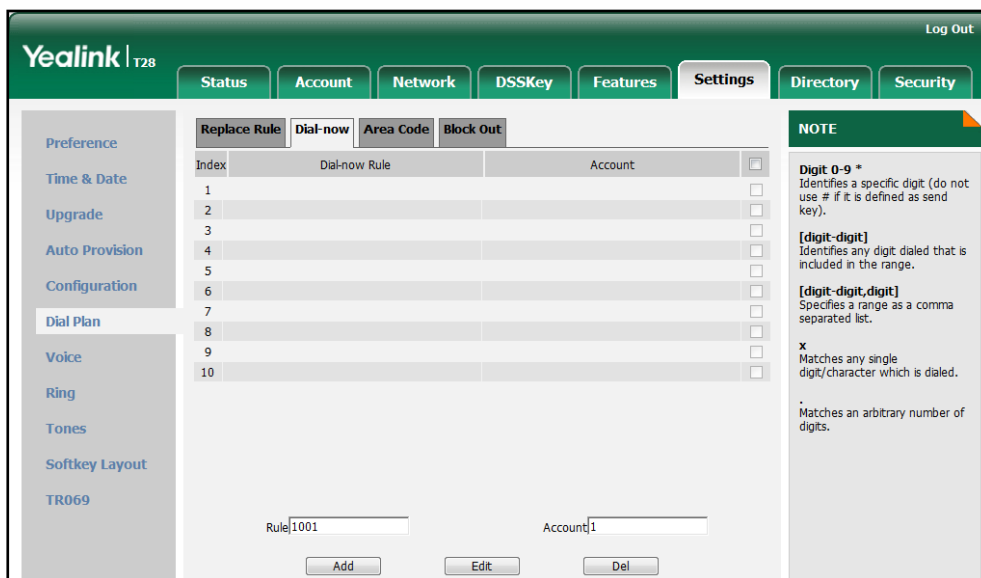

4. Click **Add** to add the dial-now rule.

To configure the delay time for the dial-now rule via web user interface:

1. Click on **Features->General Information**.
2. Enter the desired time within 1-14 (in seconds) in the **Time-Out For Dial-Now Rule** field.

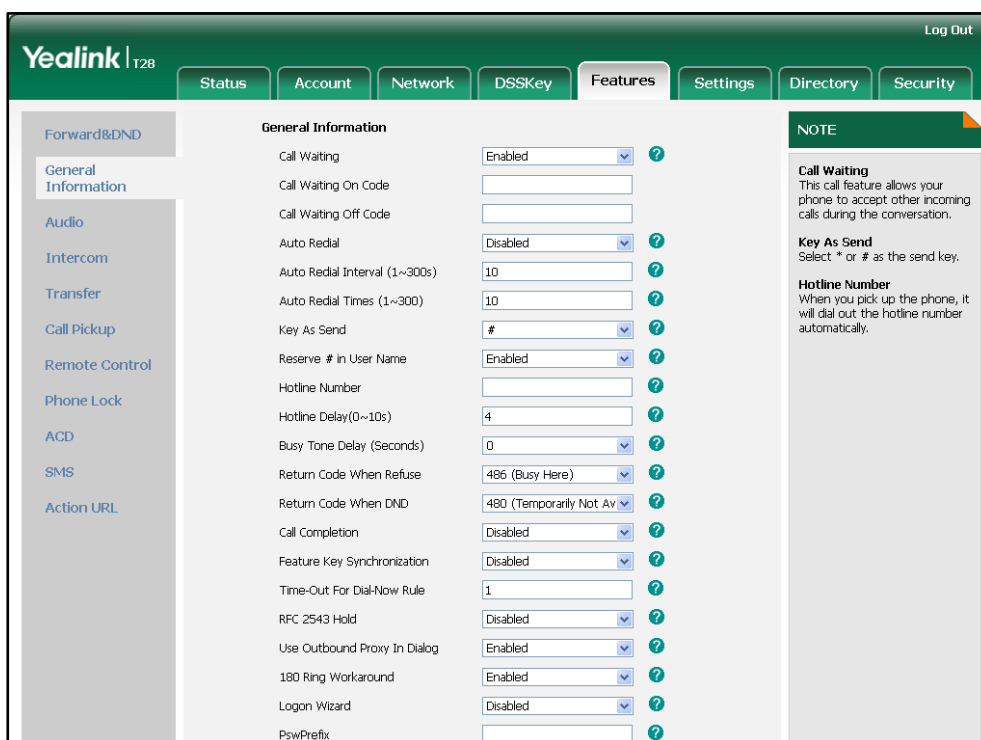

3. Click **Confirm** to accept the change.



## Area Code

Area codes are also known as Numbering Plan Areas (NPAs). They usually indicate geographical areas in one country. When entered numbers match the predefined area code rule, the IP phone will automatically add the area code before the numbers and dial out. IP phones only support one area code rule.

### Procedure

Area code rule can be configured using the configuration files or locally.

<b>Configuration File</b>	<y0000000000xx>.cfg	Create the area code rule and specify the maximum and minimum lengths of entered numbers. For more information, refer to <a href="#">Dial Plan</a> on page 255.
<b>Local</b>	Web User Interface	Create the area code rule and specify the maximum and minimum lengths of entered numbers. <b>Navigate to:</b> http://<phoneIPAddress>/servlet?p=settings-areacode&q=load

**To configure an area code rule via web user interface:**

1. Click on **Settings->Dial Plan->Area Code**.
2. Enter the desired values in the **Code**, **Min Length (1-15)** and **Max Length (1-15)** fields.
3. Enter the desired line ID in the **Account** field or leave it blank.

If you leave this field blank or enter 0, the area code rule applies to all accounts on the IP phone.

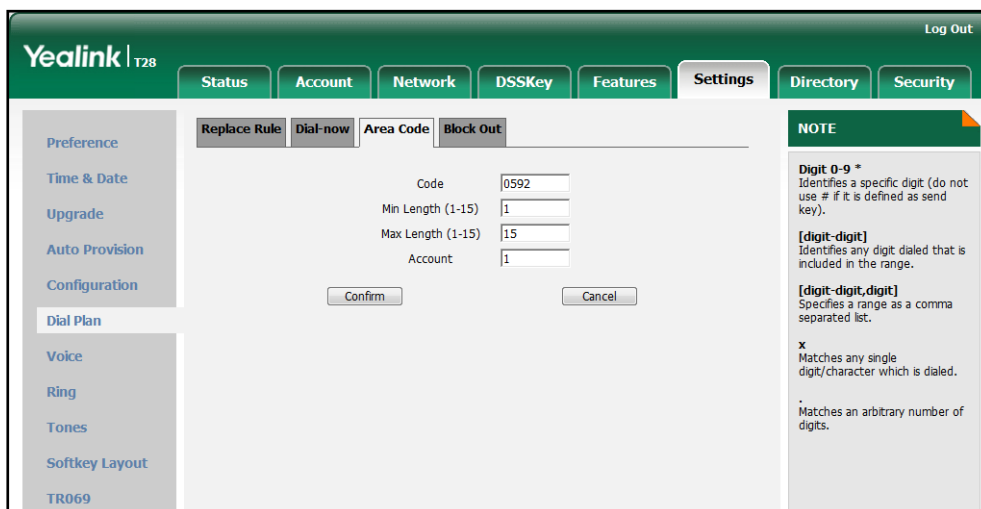

4. Click **Confirm** to accept the change.

## Block Out

Block out rule prevents users from dialing out specific numbers. When entered numbers match the predefined block out rule, the LCD screen prompts "Forbidden Number". IP phones support up to 10 block out rules.

### Procedure

Block out rule can be created using the configuration files or locally.

<b>Configuration File</b>	<y0000000000xx>.cfg	Create the block out rule for the IP phone. For more information, refer to <a href="#">Dial Plan</a> on page 255.
<b>Local</b>	Web User Interface	Create the block out rule for the desired line. <b>Navigate to:</b> http://<phoneIPAddress>/servlet?p=settings-blackout&q=load

**To create a block out rule via web user interface:**

1. Click on **Settings->Dial Plan->Block Out**.
2. Enter the desired value in the **BlockOut Number** field.
3. Enter the desired line ID in the **Account** field or leave it blank.

If you leave this field blank or enter 0, the block out rule applies to all accounts on

the IP phone.

Yealink | T28 Log Out

Status Account Network DSSKey Features **Settings** Directory Security

Preference  
Time & Date  
Upgrade  
Auto Provision  
Configuration  
Dial Plan  
Voice  
Ring  
Tones  
Softkey Layout  
TR069

Replace Rule Dial-now Area Code **Block Out**

BlockOut Number1	<input type="text" value="4321"/>	Account	<input type="text" value="2"/>
BlockOut Number2	<input type="text"/>	Account	<input type="text"/>
BlockOut Number3	<input type="text"/>	Account	<input type="text"/>
BlockOut Number4	<input type="text"/>	Account	<input type="text"/>
BlockOut Number5	<input type="text"/>	Account	<input type="text"/>
BlockOut Number6	<input type="text"/>	Account	<input type="text"/>
BlockOut Number7	<input type="text"/>	Account	<input type="text"/>
BlockOut Number8	<input type="text"/>	Account	<input type="text"/>
BlockOut Number9	<input type="text"/>	Account	<input type="text"/>
BlockOut Number10	<input type="text"/>	Account	<input type="text"/>

**NOTE**

**Digit 0-9 \***  
Identifies a specific digit. (do not use # if it is defined as send key).

**[digit-digit]**  
Identifies any digit dialed that is included in the range.

**[digit-digit,digit]**  
Specifies a range as a comma separated list.

**x**  
Matches any single digit/character which is dialed.

**.**  
Matches an arbitrary number of digits.

4. Click **Confirm** to add the block out rule.



# Configuring Basic Features

---

This chapter provides information for making configuration changes for the following basic features:

- Contrast
- Backlight
- User Password
- Administrator Password
- Phone Lock
- Time and Date
- Language
- Logo Customization
- Softkey Layout
- Key as Send
- Hotline
- Call Log
- Missed Call Log
- Local Directory
- Live Dialpad
- Call Waiting
- Auto Redial
- Auto Answer
- Call Completion
- Anonymous Call
- Anonymous Call Rejection
- Do Not Disturb
- Busy Tone Delay
- Return Code When Refuse
- Early Media
- 180 Ring Workaround
- Use Outbound Proxy in Dialog
- SIP Session Timer
- Session Timer

- [Call Hold](#)
- [Call Forward](#)
- [Call Transfer](#)
- [Network Conference](#)
- [Transfer on Conference Hang Up](#)
- [Directed Call Pickup](#)
- [Group Call Pickup](#)
- [Dialog Info Call Pickup](#)
- [Call Return](#)
- [Call Park](#)
- [Web Server Type](#)
- [Calling Line Identification Presentation](#)
- [Connected Line Identification Presentation](#)
- [DTMF](#)
- [Suppress DTMF Display](#)
- [Transfer via DTMF](#)
- [Intercom](#)

## Contrast

Contrast determines the readability of the texts displayed on the LCD screen. Adjusting the contrast to a comfortable level can optimize the screen viewing experience. When configured properly, contrast allows for easy reading of LCD screen display with minimal eyestrain. The contrast of the LCD screen is applicable to SIP-T19P, SIP-T21P and SIP-T28P IP phones.

### Procedure

Contrast can be configured using the configuration files or locally.

<b>Configuration File</b>	<y000000000xx>.cfg	Configure the contrast of the LCD screen. For more information, refer to <a href="#">Contrast</a> on page 259.
<b>Local</b>	Web User Interface	Configure the contrast of the LCD screen. <b>Navigate to:</b> http://<phoneIPAddress>/servlet?p=settings-preference&q=load

	Phone User Interface	Configure the contrast of the LCD screen.
--	----------------------	---

To configure contrast via web user interface:

1. Click on **Settings->Preference**.
2. Select the desired value from the pull-down list of **Contrast**.

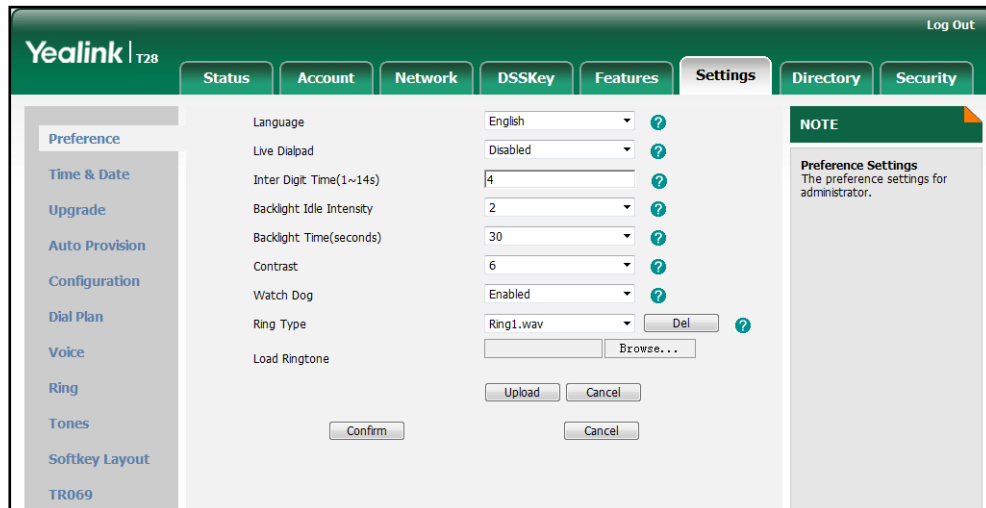

3. Click **Confirm** to accept the change.

To configure contrast via phone user interface (only applicable to the SIP-T28P IP phone):

1. Press **Menu->Settings->Advanced Settings** (password: admin) -> **Phone Settings->Contrast**.
2. Press **◀** or **▶**, or the **Switch** soft key to increase or decrease the intensity of contrast.  
The default contrast level is 6.
3. Press the **Save** soft key to accept the change.

To configure contrast via phone user interface (applicable to SIP-T19P and SIP-T21P IP phones):

1. Press **Menu->Settings->Basic Setting->Contrast**.
2. Press **◀** or **▶**, or the **Switch** soft key to increase or decrease the intensity of contrast.  
The default contrast level is 6.
3. Press the **Save** soft key to accept the change.

## Backlight

Backlight determines the brightness of the LCD screen display, allowing for easy reading in darkened environments. Backlight feature is not applicable to SIP-T19P

SIP-T20P and SIP-T21P IP phones. Backlight time specifies the delay time to turn off the backlight when the IP phone is inactive. Backlight turns off quickly if a short backlight time is configured, this may not give users enough time to read messages. Backlight idle intensity is used to adjust the backlight intensity of the LCD screen. Backlight idle intensity is only applicable to the SIP-T28P IP phone.

You can configure the backlight time as one of the following types:

- **Always Off:** Backlight is turned off permanently.
- **Always On:** Backlight is turned on permanently.
- **15, 30, 60 or 120:** Backlight is turned off when the IP phone is inactive after a preset period of time (in seconds), but it is automatically turned on if the status of the IP phone changes or any key is pressed.

The following table lists available methods and configuration options to configure the backlight of each phone model.

Phone Model	Configuration Methods	Configuration Options
SIP-T28P	Configuration Files Web User Interface Phone User Interface	Backlight Idle Intensity Backlight Time
SIP-T26P	Configuration Files Web User Interface	Backlight Time
SIP-T22P	Configuration Files Web User Interface	Backlight Time

## Procedure

Backlight can be configured using the configuration files or locally.

<b>Configuration File</b>	<y0000000000xx>.cfg	Configure the backlight of the LCD screen. For more information, refer to <a href="#">Backlight</a> on page 259.
<b>Local</b>	Web User Interface	Configure the backlight of the LCD screen. <b>Navigate to:</b> http://<phoneIPAddress>/servlet?p=settings-preference&q=load
	Phone User Interface	Configure the backlight of the LCD screen (only applicable to the SIP-T28P IP phone).



To configure backlight via web user interface:

1. Click on **Settings->Preference**.
2. Select the desired value from the pull-down list of **Backlight Idle Intensity**.  
It is only applicable to the SIP-T28P IP phone.
3. Select the desired value from the pull-down list of **Backlight Time (seconds)**.

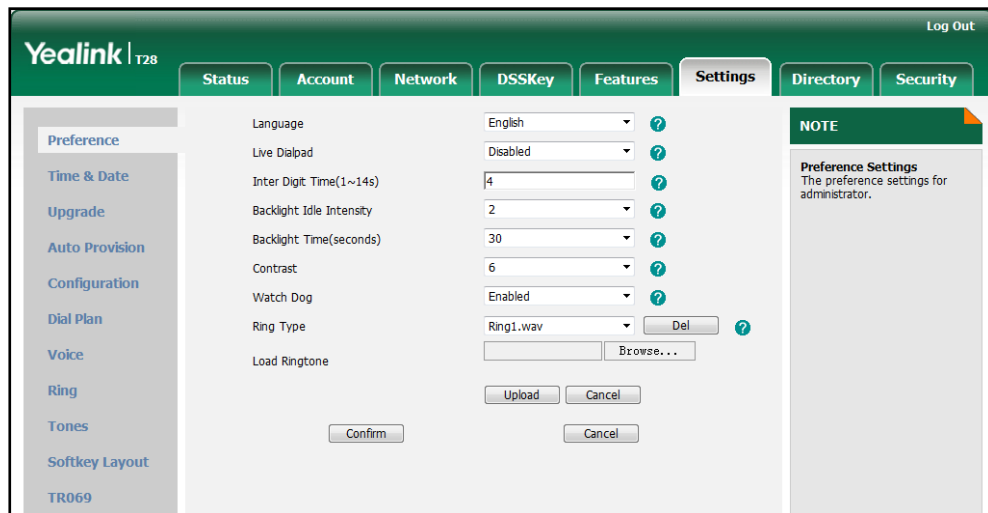

4. Click **Confirm** to accept the change.

To configure backlight via phone user interface (only applicable to the SIP-T28P IP phone):

1. Press **Menu->Settings->Advanced Settings** (password: admin) -> **Phone Settings->Backlight**.
2. Press **◀** or **▶**, or the **Switch** soft key to select the desired level from the **Backlight Intensity** field.
3. Press **◀** or **▶**, or the **Switch** soft key to select the desired type from the **Backlight Time** field.
4. Press the **Save** soft key to accept the change.

## User Password

Some menu options are protected with two privilege levels, user and administrator, each with its own password. When logging into the web user interface, you need to enter the user name and password to access various menu options.

A user or an administrator can change the user password. The default user password is "user". For security reasons, the user or administrator should change the default user password as soon as possible.

## Procedure

User password can be changed using the configuration files or locally.

<b>Configuration File</b>	<y0000000000xx>.cfg	Change the user password of the IP phone. For more information, refer to <a href="#">User Password</a> on page 260.
<b>Local</b>	Web User Interface	Change the user password of the IP phone. <b>Navigate to:</b> http://<phoneIPAddress>/servlet?p=security&q=load

### To change the user password via web user interface:

1. Click on **Security->Password**.
2. Select **user** from the pull-down list of **User Type**.
3. Enter new password in the **New Password** and **Confirm Password** fields.

The new password should be complex and contains at least 6 characters, where at least one character is numeric, and one character is alphabetic. Valid characters contain A-Z, a-z, 0-9, #, !, @, -, ., \*, + and \$.

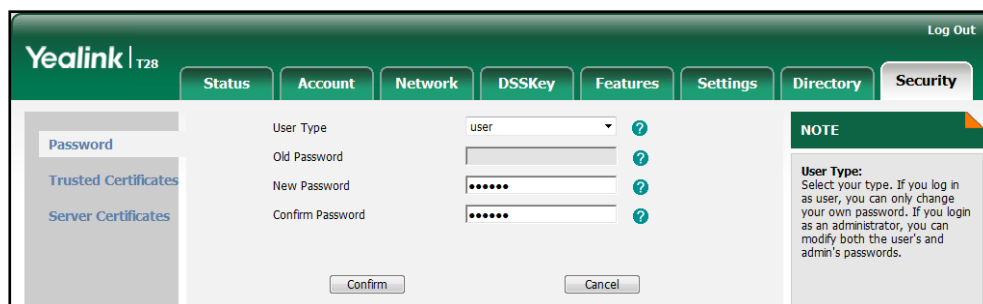

4. Click **Confirm** to accept the change.

**Note** If logging into the web user interface of the phone with the user credential, you need to enter the old user password in the **Old Password** field.

## Administrator Password

Advanced menu options are strictly for use by administrators. Users can configure them only if they have administrator privileges. The administrator password can only be changed by an administrator. The default administrator password is "admin". For security reasons, the administrator should change the default administrator password as soon as possible.

## Procedure

Administrator password can be changed using the configuration files or locally.

<b>Configuration File</b>	<y0000000000xx>.cfg	Change the administrator password. For more information, refer to <a href="#">Administrator Password</a> on page 260.
<b>Local</b>	Web User Interface	Change the administrator password. <b>Navigate to:</b> http://<phoneIPAddress>/servlet?p=security&q=load
	Phone User Interface	Change the administrator password.

**To change the administrator password via web user interface:**

1. Click on **Security->Password**.
2. Select **admin** from the pull-down list of **User Type**.
3. Enter the current administrator password in the **Old Password** field.
4. Enter new password in the **New Password** and **Confirm Password** fields.

The new password should be complex and contains at least 6 characters, where at least one character is numeric, and one character is alphabetic. Valid characters contain A-Z, a-z, 0-9, #, !, @, -, ., \*, + and \$.

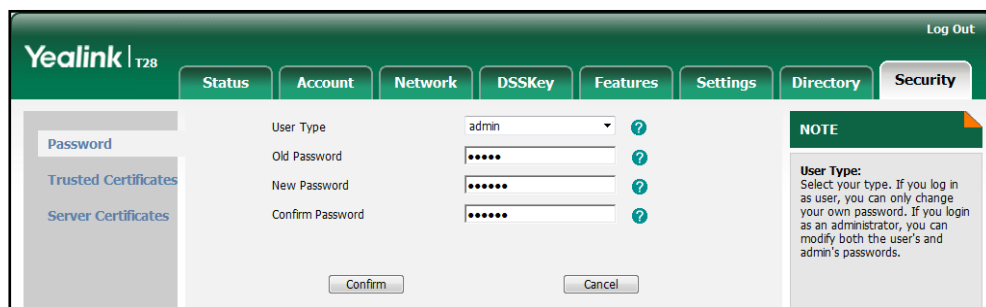

5. Click **Confirm** to accept the change.

**To change the administrator password via phone user interface:**

1. Press **Menu->Settings->Advanced Settings** (password: admin) -> **Set Password**.
2. Enter the current administrator password in the **Current PWD** field.
3. Enter new password in the **New PWD** field and **Confirm PWD** field.
4. Press the **Save** soft key to accept the change.

## Phone Lock

Phone lock is used to lock the IP phone to prevent it from unauthorized use. Once the IP phone is locked, a user must enter the password to unlock it. IP phones offer three types of phone lock: Menu Key, Function Keys and All Keys. The IP phone will not be locked immediately after the phone lock type is configured. One of the following steps is also needed:

- Long press the pound key when the IP phone is idle.
- Press the keypad lock key (if configured) when the IP phone is idle.

In addition to the above steps, you can configure the IP phone to automatically lock the keypad after a period of time.

### Procedure

Phone lock can be configured using the configuration files or locally.

<p><b>Configuration File</b></p>	<p>&lt;y0000000000xx&gt;.cfg</p>	<p>Configure the type of phone lock.</p> <p>Change the unlock PIN.</p> <p>Configure the IP phone to automatically lock the keypad after a time interval.</p> <p>For more information, refer to <a href="#">Phone Lock</a> on page 261.</p> <p>Assign a keypad lock key.</p> <p>For more information, refer to <a href="#">Keypad Lock Key</a> on page 383.</p>
<p><b>Local</b></p>	<p>Web User Interface</p>	<p>Configure the type of phone lock.</p> <p>Change the unlock PIN.</p> <p>Configure the IP phone to automatically lock the keypad after a time interval.</p> <p><b>Navigate to:</b>  <a href="http://&lt;phoneIPAddress&gt;/servlet?&amp;p=features-phonelock&amp;q=load">http://&lt;phoneIPAddress&gt;/servlet?&amp;p=features-phonelock&amp;q=load</a></p> <p>Assign a keypad lock key.</p> <p><b>Navigate to:</b>  <a href="http://&lt;phoneIPAddress&gt;/servlet?&amp;p=dsskey&amp;q=load&amp;model=">http://&lt;phoneIPAddress&gt;/servlet?&amp;p=dsskey&amp;q=load&amp;model=</a></p>

		0
	Phone User Interface	<p>Configure the type of phone lock.</p> <p>Change the unlock password.</p> <p>Assign a keypad lock key.</p>

To configure phone lock via web user interface:

1. Click on **Features->Phone Lock**.
2. Select the desired type from the pull-down list of **Keypad Lock Type**.
3. Enter the unlock PIN in the **Phone Unlock PIN (0~15 Digit)** field.
4. Enter the desired time in the **Phone Lock Time Out (0~3600s)** field.

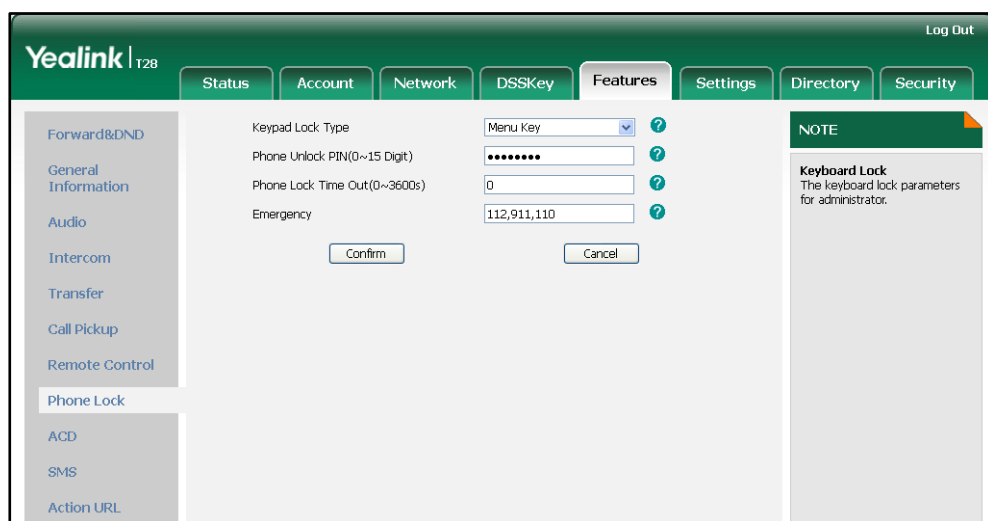

5. Click **Confirm** to accept the change.

To configure a keypad lock key via web user interface:

1. Click on **DSSKey->Memory Key (Line Key or Programable Key)**.

- In the desired DSS key field, select **Keypad Lock** from the pull-down list of **Type**.

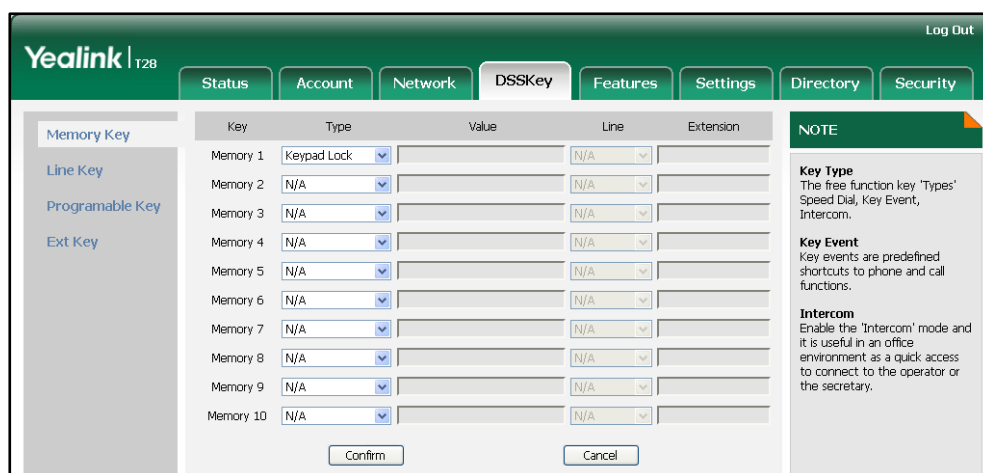

- Click **Confirm** to accept the change.

To configure the type of phone lock via phone user interface:

- Press **Menu->Settings->Advanced Settings** (password: admin) -> **Phone Settings->Keypad Lock**.
- Press **◀** or **▶**, or the **Switch** soft key to select the desired type from the **Keypad Lock** field.
- Press the **Save** soft key to accept the change.

To change the unlock PIN via phone user interface:

- Press **Menu->Settings->Basic Settings->Phone Unlock PIN**.
- Enter the current unlock PIN in the **Current PIN** field.
- Enter the new unlock PIN in the **New PIN** field.
- Press the **Save** soft key to accept the change.

To configure a keypad lock key via phone user interface:

- Press **Menu->Features->DSS Keys->Memory Keys** (or **Line Keys**).
- Select the desired DSS key.
- Press **◀** or **▶**, or the **Switch** soft key to select **Keypad Lock** from the **Type** field.
- Press the **Save** soft key to accept the change.

## Time and Date

IP phones maintain a local clock and calendar. Time and date display on the idle screen of IP phones. Time and date are synced automatically from the NTP server by default. If IP phones cannot obtain the time and date from the NTP server, you need to manually configure them. The time and date display can use one of several different formats.

## Time Zone

A time zone is a region on Earth that has a uniform standard time. It is convenient for areas in close commercial or other communication to keep the same time. When configuring the IP phone to obtain the time and date from the NTP server, you must set the time zone.

## Daylight Saving Time

Daylight Saving Time (DST) is the practice of temporary advancing clocks during the summertime so that evenings have more daylight and mornings have less. Typically clocks are adjusted forward one hour at the start of spring and backward in autumn. Many countries have used the DST at various times, details vary by location. The DST can be adjusted automatically from the time zone configuration. Typically, there is no need to change this setting.

The following table lists available configuration methods for time and date.

Option	Configuration Methods
Time Zone	Configuration Files Web User Interface Phone User Interface
Time	Web User Interface Phone User Interface
Time Format	Configuration Files Web User Interface Phone User Interface
Date	Web User Interface Phone User Interface
Date Format	Configuration Files Web User Interface Phone User Interface
Daylight Saving Time	Configuration Files Web User Interface

## Procedure

Configuration changes can be performed using the configuration files or locally.

<b>Configuration File</b>	<y0000000000xx>.cfg	Configure the NTP server, time zone and DST. Configure the time and date
---------------------------	---------------------	---

		<p>manually.</p> <p>Configure the time and date formats.</p> <p>For more information, refer to <a href="#">Time and Date</a> on page 264.</p>
Local	Web User Interface	<p>Configure the NTP server, time zone and DST.</p> <p>Configure the time and date manually.</p> <p>Configure the time and date formats.</p> <p><b>Navigate to:</b>  <a href="http://&lt;phoneIPAddress&gt;/servlet?p=settings-datetime&amp;q=load">http://&lt;phoneIPAddress&gt;/servlet?p=settings-datetime&amp;q=load</a></p>
	Phone User Interface	<p>Configure the NTP server and time zone.</p> <p>Configure the time and date manually.</p> <p>Configure the time and date formats.</p>

**To configure the NTP server, time zone and DST via web user interface:**

1. Click on **Settings->Time & Date**.
2. Select **Disabled** from the pull-down list of **Manual Time**.
3. Select the desired time zone from the pull-down list of **Time Zone**.
4. Enter the domain names or IP addresses in the **Primary Server** and **Secondary Server** fields respectively.
5. Enter the desired time interval in the **Synchronism (1~86400s)** field.



6. Select the desired value from the pull-down list of **Daylight Saving Time**.

If you select **Enabled**, do one of the following:

- Mark the **DST By Date** radio box in the **Fixed Type** field.  
Enter the start time in the **Start Date** field.  
Enter the end time in the **End Date** field.

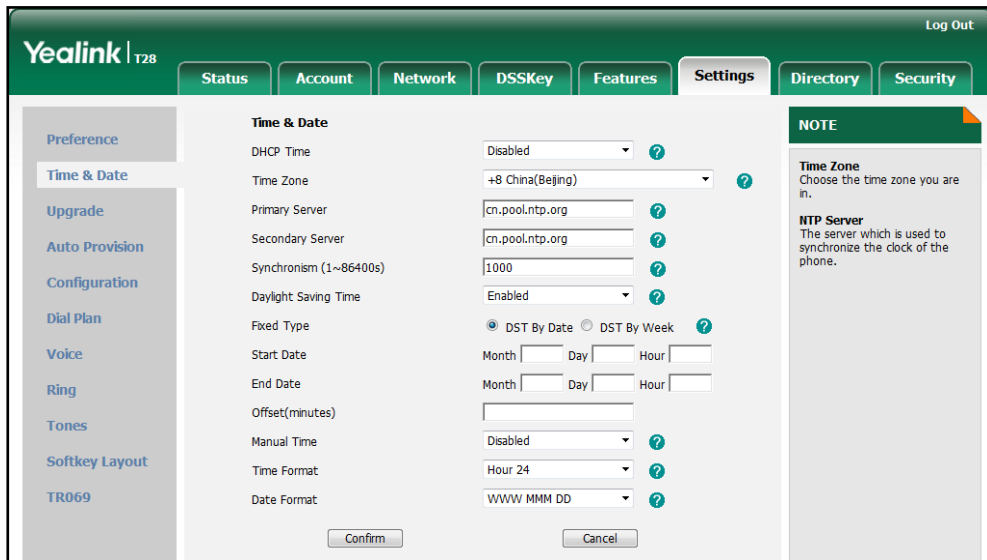

- Mark the **DST By Week** radio box in the **Fixed Type** field.

Select the desired values from the pull-down lists of **DST Start Month**, **DST Start Day of Week**, **DST Start Day of Week Last in Month**, **DST Stop Month**, **DST Stop Day of Week** and **DST Stop Day of Week Last in Month**.

Enter the desired time in the **Start Hour of Day** field.

Enter the desired time in the **End Hour of Day** field.

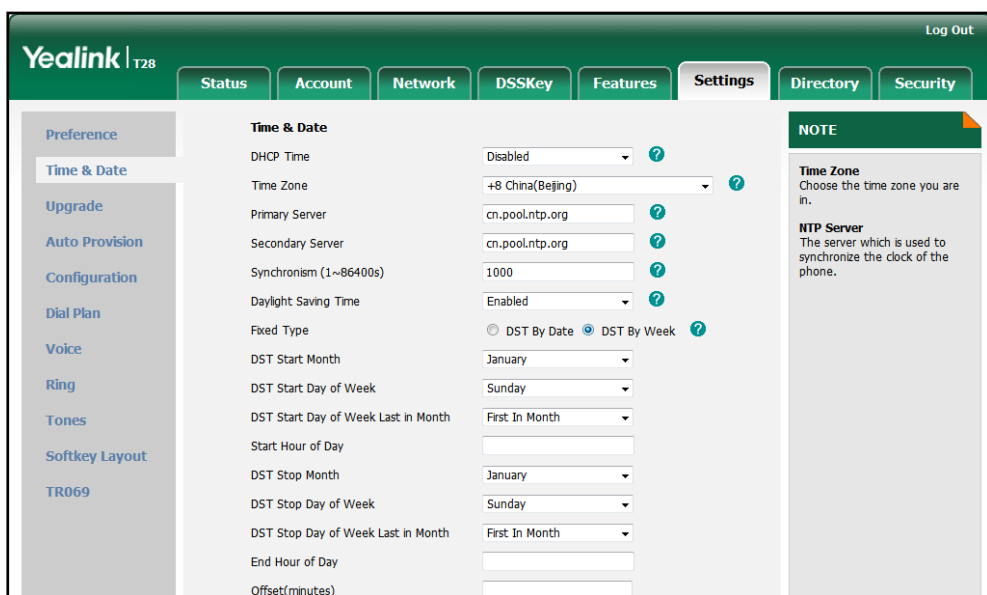

7. Enter the desired offset time in the **Offset (minutes)** field.

8. Click **Confirm** to accept the change.

To configure the time and date manually via web user interface:

1. Click on **Settings->Time & Date**.
2. Select **Enabled** from the pull-down list of **Manual Time**.
3. Enter the time and date in the corresponding fields.

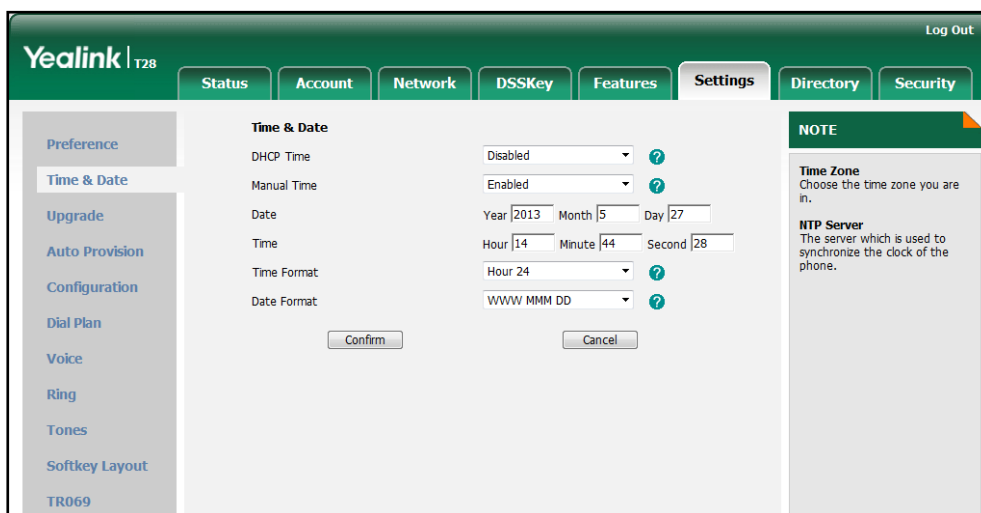

4. Click **Confirm** to accept the change.

To configure the time and data format via web user interface:

1. Click on **Settings->Time & Date**.
2. Select the desired value from the pull-down list of **Time Format**.
3. Select the desired value from the pull-down list of **Date Format**.

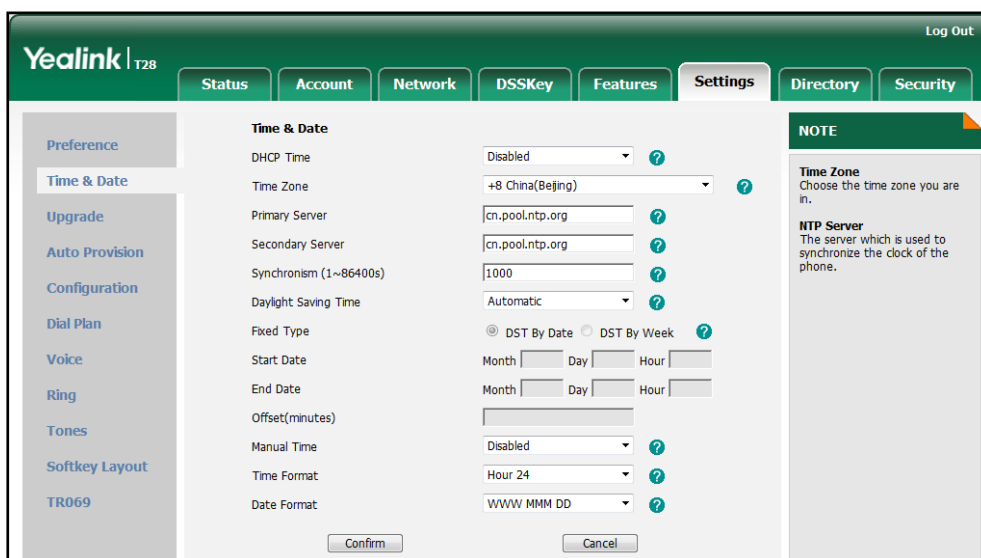

4. Click **Confirm** to accept the change.

**To configure the NTP server and time zone via phone user interface:**

1. Press **Menu->Settings->Basic Settings->Time & Date->SNTP Settings**.
2. Press ◀ or ▶, or the **Switch** soft key to select the time zone that applies to your area from the **Time Zone** field.  
The default time zone is "+8 China(Beijing)".
3. Enter the domain names or IP addresses in the **NTP Server1** and **NTP Server2** fields respectively.
4. Press the **Save** soft key to accept the change.

**To configure the time and date manually via phone user interface:**

1. Press **Menu->Settings->Basic Settings->Time & Date->Manual Settings**.
2. Enter the date in the **Date** field.
3. Enter the time in the **Time** field.
4. Press the **Save** soft key to accept the change.

**To configure the time and date formats via phone user interface:**

1. Press **Menu->Settings->Basic Settings->Time & Date->Time & Date Format**.
2. Press ◀ or ▶, or the **Switch** soft key to select the desired time format from the **Clock** field.
3. Press ◀ or ▶, or the **Switch** soft key to select the desired date format from the **Date Format** field.
4. Press the **Save** soft key to accept the change.

## Language

IP phones support multiple languages. Languages used on the phone user interface and web user interface can be specified respectively as required.

The following table lists languages supported by the phone user interface and the web user interface respectively.

Phone User Interface	Web User Interface
English	English
German	Chinese_S (only applicable to SIP-T19P and SIP-T21P IP phones)
Chinese_S (only applicable to SIP-T19P and SIP-T21P IP phones)	German
Chinese_T (only applicable to SIP-T19P and SIP-T21P IP phones)	French (not applicable to SIP-T19P and SIP-T21P IP phones)
French	Italian
Italian	Portuguese (not applicable to

Phone User Interface	Web User Interface
Portuguese	SIP-T19P and SIP-T21P IP phones)
Polish	Spanish (not applicable to
Spanish	SIP-T19P and SIP-T21P IP phones)
Turkish	Turkish

## Loading Language Packs

Not all of supported languages are available for selection. Languages available for selection depend on language packs currently loaded on the IP phone. You can make languages available for use on the phone user interface by loading language packs to the IP phone. Language packs can only be loaded using configuration files.

The following table lists available languages and associated language packs.

Available Language	Associated Language Pack
English	lang+English.txt
Chinese_S (only applicable to SIP-T19P and SIP-T21P IP phones)	lang-Chinese_S.txt (only applicable to SIP-T19P and SIP-T21P IP phones)
Chinese_T (only applicable to SIP-T19P and SIP-T21P IP phones)	lang-Chinese_T.txt (only applicable to SIP-T19P and SIP-T21P IP phones)
Deutsch	lang-German.txt
French	lang-French.txt
Italian	lang-Italian.txt
Portuguese	lang-Portuguese.txt
Polish	lang-Polish.txt
Spanish	lang-Spanish.txt
Turkish	lang-Turkish.txt

### Procedure

Loading language pack can only be performed using the configuration files.

<b>Configuration File</b>	<y0000000000xx>.cfg	Specify the access URL of the language pack. For more information, refer to <a href="#">Language</a> on page 269.
---------------------------	---------------------	--

## Specifying the Language to Use

The default language used on the phone user interface is English. The default language used on the web user interface depends on the language preferences in the browser (if the language is not supported by the IP phone, the web user interface uses English). You can specify the languages for the phone user interface and web user interface respectively.

### Procedure

Specify the language for the phone user interface or the web user interface using the configuration files or locally.

<b>Configuration File</b>	<y0000000000xx>.cfg	Specify the languages for the phone user interface and the web user interface. For more information, refer to <a href="#">Language</a> on page 269.
<b>Local</b>	Web User Interface	Specify the language for the web user interface. <b>Navigate to:</b> http://<phoneIPAddress>/servlet?&p=settings-preference&q=load
	Phone User Interface	Specify the language for the phone user interface.

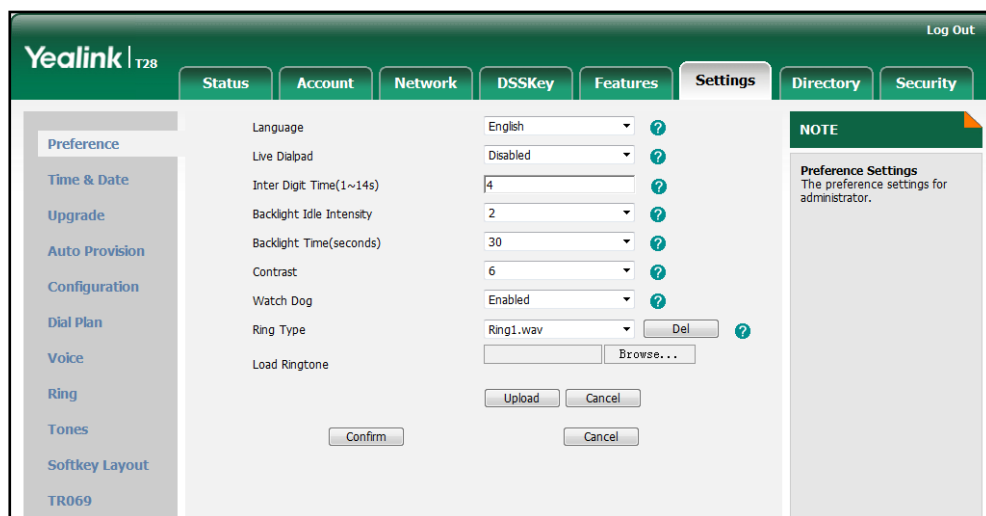

To specify the language for the web user interface via web user interface:

1. Click on **Settings->Preference**.
2. Select the desired language from the pull-down list of **Language**.



3. Click **Confirm** to accept the change.

To specify the language for the phone user interface via phone user interface:

1. Press **Menu->Settings->Basic Settings->Language**.
2. Press  or  to select the desired language.
3. Press the **Save** soft key to accept the change.

## Logo Customization

Logo customization allows unifying the IP phone appearance or displaying a custom image on the idle screen such as a company logo, instead of the default system logo. The SIP-T20P IP phone only supports a text logo.

The following table lists the logo file format and resolution for each phone model.

Phone Model	Logo File Format	Resolution
SIP-T28P	.dob	<b>&lt;=236*82</b> 2 gray scale
SIP-T26P	.dob	<b>&lt;=132*64</b> 2 gray scale
SIP-T22P/T21P/T19P	.dob	<b>&lt;=132*64</b> 2 gray scale

### Note

The format of the logo file must be \*.dob. Before uploading your custom logo to IP phones, ensure your logo file is correctly formatted. For more information on customizing a logo file, refer to *Yealink SIP-T2 Series/T3 Series/T19P/VP530 IP Phones Auto Provisioning Guide*.

## Procedure

The logo shown on the idle screen can be configured using the configuration files or locally.

<b>Configuration File</b>	<y0000000000xx>.cfg	Configure the logo shown on the idle screen. For more information, refer to on <a href="#">Logo Customization</a> on page 271.
<b>Local</b>	Web User Interface	Configure the logo shown on the idle screen. <b>Navigate to:</b> http://<phoneIPAddress>/servlet?p=features-general&q=load

To configure a custom logo via web user interface (not applicable to the SIP-T20P IP phone):

1. Click on **Features->General Information**.
2. Select **Custom logo** from the pull-down list of **Use Logo**.

The screenshot shows the Yealink T28 web interface. The 'Features' tab is active, and the 'General Information' sub-tab is selected. The 'Use Logo' dropdown menu is open, showing 'Custom logo' as the selected option. Below this, there is an 'Upload Logo' section with a file input field, a 'Browse...' button, and 'Upload' and 'Cancel' buttons. Other settings include 'Call Waiting' (Enabled), 'Call Waiting On Code', 'Call Waiting Off Code', 'Auto Redial' (Disabled), 'Auto Redial Interval (1~300s)' (10), 'Allow IP Call' (Enable), 'IP Direct Auto Answer' (Disabled), 'Call List Show Number' (Disabled), 'Voice Mail Tone' (Enable), 'DHCP Hostname' (SIP-T28P), and 'Reboot In Talking' (Disabled). A 'NOTE' section on the right provides information about 'Call Waiting', 'Key As Send', and 'Hotline Number'.

3. Click **Browse** to select the logo file from your local system.
4. Click **Upload** to upload the file.
5. Click **Confirm** to accept the change.

For SIP-T28P IP phone, the custom logo displays on the idle screen. For SIP-T26P/T22P/T21P/T19P IP phone, the custom logo screen and the idle screen alternately display.

To configure a text logo via web user interface (only applicable to the SIP-T20P IP phone):

1. Click on **Features->General Information**.
2. Select the desired value from the pull-down list of **User Logo**.

- Enter the desired texts (0~15 characters) in the **Text Logo** field.

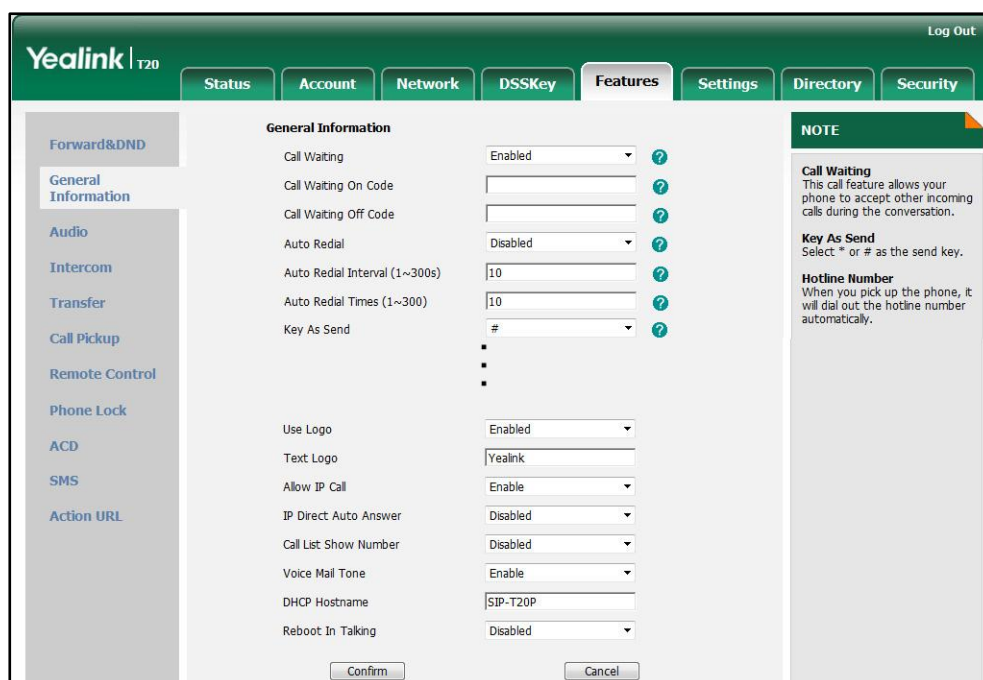

- Click **Confirm** to accept the change.

The registered account and the configured text logo alternately display on the LCD screen.

## Softkey Layout

Softkey layout is used to customize the soft keys at the bottom of the LCD screen to best suit user needs. It can be configured based on call states. In addition to specifying which soft keys to display, you can determine their display order. Softkey layout is not applicable to the SIP-T20P IP phone. You can create softkey layout templates for different call states. For more information on the softkey layout template, refer to [Softkey Layout Template](#) on page 223.

The following table lists soft keys available for IP phones in different call states.

Call State	Default Soft Keys	Optional Soft Keys
CallFailed	NewCall Empty Empty Empty	Empty Switch Cancel
CallIn	Answer Forward Silence	Empty Switch



Call State		Default Soft Keys	Optional Soft Keys
		Reject	
Connecting	Connecting	Empty Empty Empty Cancel	Empty Switch
	SemiAttendTrans	Transfer Empty Empty Cancel	Empty Switch
Dialing		Send IME Delete Cancel	Empty History Switch Line Directory GPickup DPickup
RingBack	RingBack	Empty Empty Empty Cancel	Empty Switch CC
	SemiAttendTransBack	Transfer Empty Empty Cancel	Empty Switch CC
Talking	Talk	Transfer Hold Conference Cancel	Empty Mute SWAP NewCall Switch Answer Reject
	Hold	Transfer Resume NewCall	Empty Switch Answer





Call State		Default Soft Keys	Optional Soft Keys
		Cancel	Reject
	Held	Empty Empty Empty Cancel	Empty Switch Answer Reject NewCall
	PreTrans	Transfer IME Delete Cancel	Empty Directory Switch Send
	InConference	Empty Empty Empty Cancel	Empty Switch
	InConferenceTalk	Empty Empty Conference Cancel	Empty Switch
	Conferenced	Empty Hold Split Cancel	Empty Switch Answer Reject Mute

### Procedure

Softkey layout can be configured using the configuration files or locally.

<b>Configuration File</b>	<y0000000000xx>.cfg	Specify the access URL of the softkey layout template. For more information, refer to <a href="#">Access URL of Softkey Layout</a> on page 371.
<b>Local</b>	Web User Interface	Configure the softkey layout. <b>Navigate to:</b> http://<phoneIPAddress>/servlet?p=settings-softkey&q=load

To configure softkey layout via web user interface:

1. Click on **Settings->Softkey Layout**.
2. Select the desired value from the pull-down list of **Custom Softkey**.
3. Select the desired state from the pull-down list of **Call States**.
4. Select the desired soft key from the **Unselected Softkeys** column and then click  .  
The selected soft key appears in the **Selected Softkeys** column.
5. Repeat the step 4 to add more soft keys to the **Selected Softkeys** column.
6. To remove the soft key from the **Selected Softkeys** column, select the desired soft key and then click  .
7. To adjust the display order of soft keys, select the desired soft key and then click  or  .

The LCD screen displays the soft keys in the adjusted order.

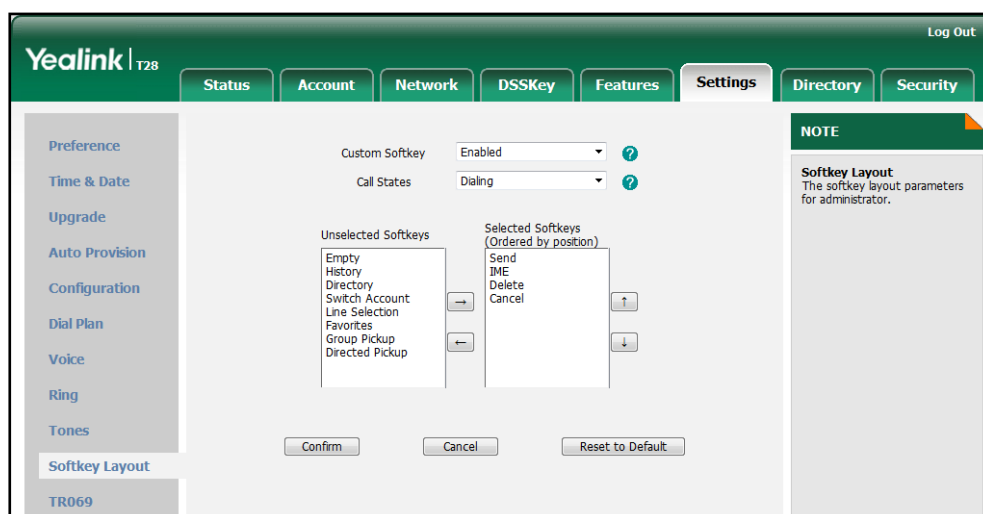

8. Click **Confirm** to accept the change.

## Key as Send

Key as send allows assigning the pound key or the star key as a send key. Send sound allows the IP phone to play a key tone when the send key is pressed. Send sound works only if key as send feature is enabled.

## Procedure

Key as send can be configured using the configuration files or locally.

<b>Configuration File</b>	<y0000000000xx>.cfg	Configure the send key. Configure send sound. For more information, refer to <a href="#">Key as Send</a> on page 272.
<b>Local</b>	Web User Interface	Configure the send key. <b>Navigate to:</b> http://<phoneIPAddress>/servlet ?p=features-general&q=load Configure send sound. <b>Navigate to:</b> http://<phoneIPAddress>/servlet ?p=features-audio&q=load
	Phone User Interface	Configure the send key.

To configure send key via web user interface:

1. Click on **Features->General Information**.
2. Select the desired value from the pull-down list of **Key As Send**.

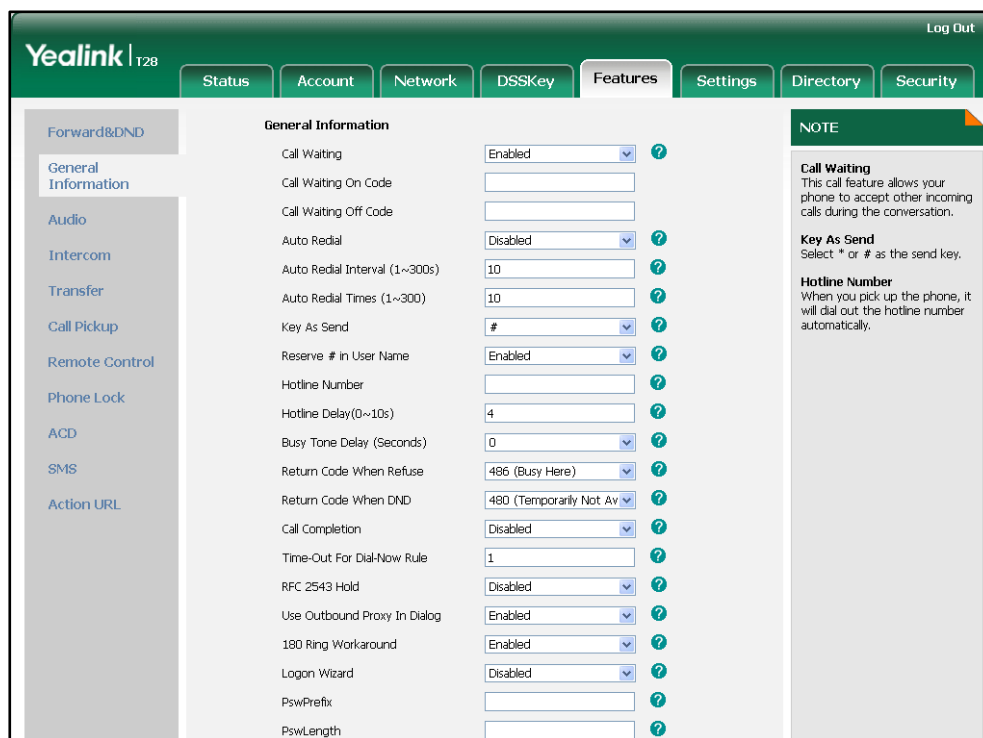

3. Click **Confirm** to accept the change.

To configure send sound via web user interface:

1. Click on **Features->Audio**.
2. Select the desired value from the pull-down list of **Send Sound**.

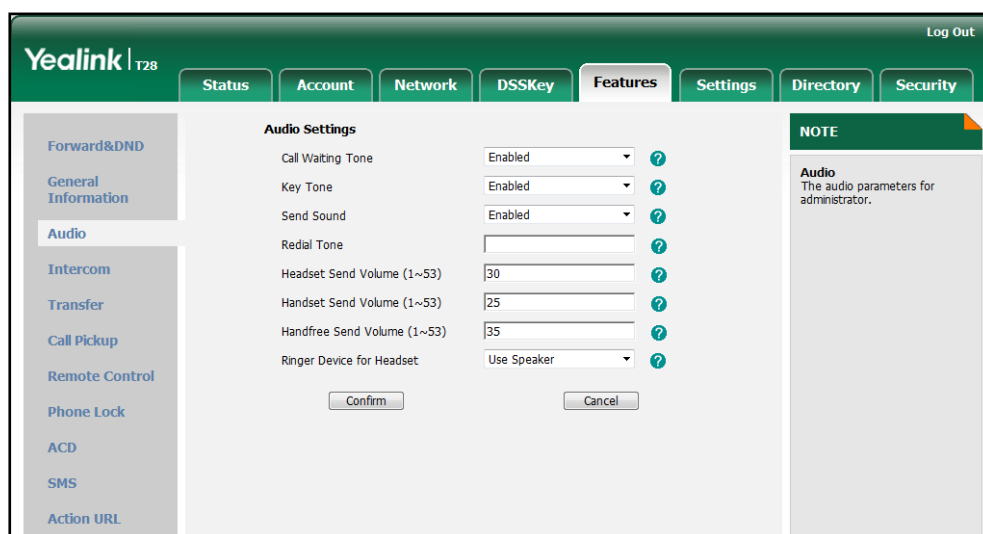

3. Click **Confirm** to accept the change.

To configure send key via phone user interface:

1. Press **Menu->Features->Key as Send**.
2. Press **◀** or **▶** , or the **Switch** soft key to select **#** or **\*** from the **Key as Send** field, or select **Disable** to disable this feature.
3. Press the **Save** soft key to accept the change.

## Hotline

Hotline is a point-to-point communication link in which a call is automatically directed to the preset hotline number. The IP phone automatically dials out the hotline number using the first available line after a specified time interval when off-hook. IP phones only support one hotline number.

### Procedure

Hotline can be configured using the configuration files or locally.

<p><b>Configuration File</b></p>	<p>&lt;y0000000000xx&gt;.cfg</p>	<p>Configure the hotline number. Specify the time (in seconds) the IP phone waits before automatically dialing out the hotline number. For more information, refer to <a href="#">Hotline</a> on page 273.</p>
----------------------------------	----------------------------------	--

<b>Local</b>	Web User Interface	<p>Configure the hotline number.</p> <p>Specify the time (in seconds) the IP phone waits before automatically dial out the hotline number.</p> <p><b>Navigate to:</b>  <a href="http://&lt;phoneIPAddress&gt;/servlet?p=features-general&amp;q=load">http://&lt;phoneIPAddress&gt;/servlet?p=features-general&amp;q=load</a></p>
	Phone User Interface	<p>Configure the hotline number.</p> <p>Specify the time (in seconds) the IP phone waits before automatically dialing out the hotline number.</p>

**To configure hotline via web user interface:**

1. Click on **Features->General Information**.
2. Enter the hotline number in the **Hotline Number** field.
3. Enter the delay time in the **Hotline Delay (0~10s)** field.

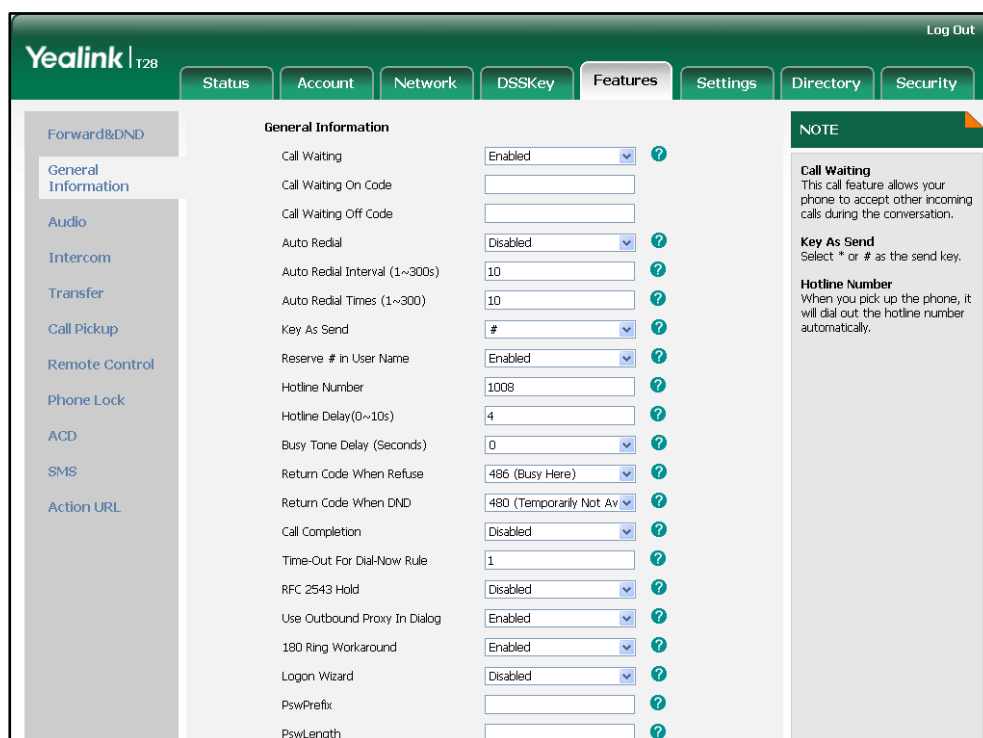

4. Click **Confirm** to accept the change.

**To configure hotline via phone user interface:**

1. Press **Menu->Features->Hot Line**.
2. Enter the hotline number in the **Hot Number** field.

3. Enter the waiting time (in seconds) in the **HotLine Delay** field.
4. Press the **Save** soft key to accept the change.

## Call Log

Call log contains call information such as remote party identification, time and date, and call duration. IP phones maintain a local call log. Call log consists of four lists: Placed Calls, Received Calls, Missed Calls and Forwarded Calls. Call log lists support 100 entries in all. To store call information, you must enable save call calllog feature in advance.

### Procedure

Call log can be configured using the configuration files or locally.

<b>Configuration File</b>	<y0000000000xx>.cfg	Configure call log feature. For more information, refer to <a href="#">Call Log</a> on page 274.
<b>Local</b>	Web User Interface	Configure call log feature. <b>Navigate to:</b> http://<phoneIPAddress>/servlet ?p=features-general&q=load
	Phone User Interface	Configure the call log.

**To configure call log feature via web user interface:**

1. Click on **Features->General Information**.

2. Select the desired value from the pull-down list of **Save Call Callog**.

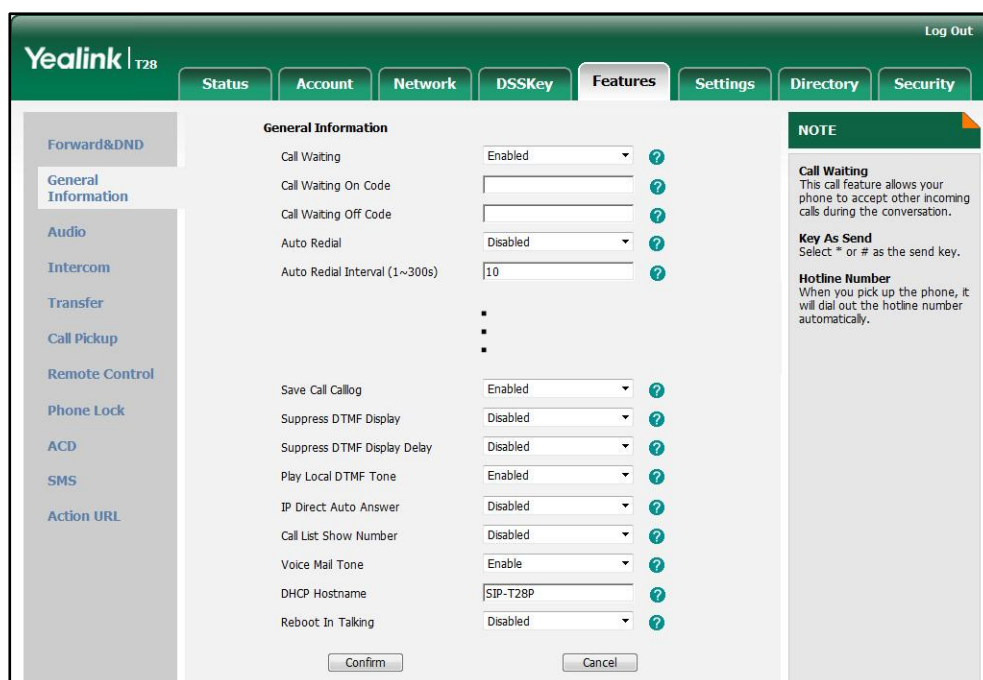

3. Click **Confirm** to accept the change.

To configure call log feature via phone user interface:

1. Press **Menu->Features->History Setting**.
2. Press **◀** or **▶**, or the **Switch** soft key to select the desired value from the **History Record** field.
3. Press the **Save** soft key to accept the change.

## Missed Call Log

Missed call log allows the IP phone to display the number of missed calls with an indicator icon on the idle screen, and to log missed calls in the Missed Calls list when the IP phone misses calls. It is configurable on a per-line basis. Once the user accesses the Missed Calls list, the prompt message and indicator icon on the idle screen disappear.

### Procedure

Missed call log can be configured using the configuration files or locally.

<b>Configuration File</b>	<MAC>.cfg	Configure missed call log feature. For more information, refer to <a href="#">Missed Call Log</a> on page 275.
<b>Local</b>	Web User Interface	Configure missed call log feature. <b>Navigate to:</b>



		http://<phoneIPAddress>/servlet ?p=account-basic&q=load&acc =0
--	--	--

To configure missed call log via web user interface:

1. Click on **Account**.
2. Select the desired account from the pull-down list of **Account**.
3. Click on **Basic**.
4. Select the desired value from the pull-down list of **Missed Call Log**.

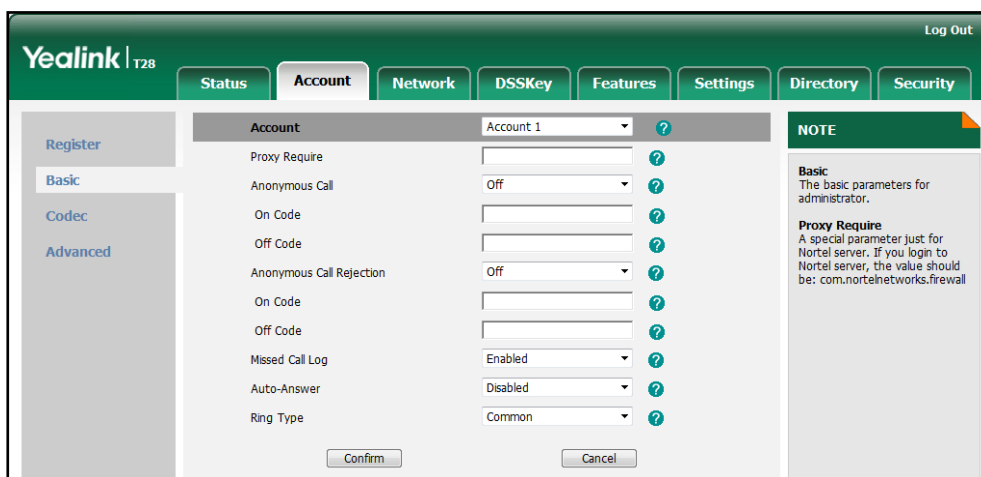

5. Click **Confirm** to accept the change.

## Local Directory

IP phones maintain a local directory. The local directory can store up to 1000 contacts and 7 groups (including the default All Contacts and Blacklist). When adding a contact to the local directory, in addition to name and phone numbers, you can also specify the account, ring tone and group for the contact. Contacts and groups can be added either one by one or in batch using a local contact file. For more information on the contact file, refer to [Local Contact File](#) on page 225.

### Procedure

Configuration changes can be performed using the configuration files or locally.

<b>Configuration File</b>	<y0000000000xx>.cfg	Specify the access URL of the local contact file. For more information, refer to <a href="#">Access URL of Local Contact File</a> on page 374.
<b>Local</b>	Web User Interface	Add a group and a contact to the

		local directory. <b>Navigate to:</b> http://<phoneIPAddress>/servlet ?p=contactsbasic&q=load&num =1&group=
	Phone User Interface	Add a group and a contact to the local directory.

**To add a group to the local directory via web user interface:**

1. Click on **Directory->Local Directory**.
2. In the **Group Setting** block, enter the desired group name in the **Group** field.
3. Select the desired ring tone from the pull-down list of **Ring** field.

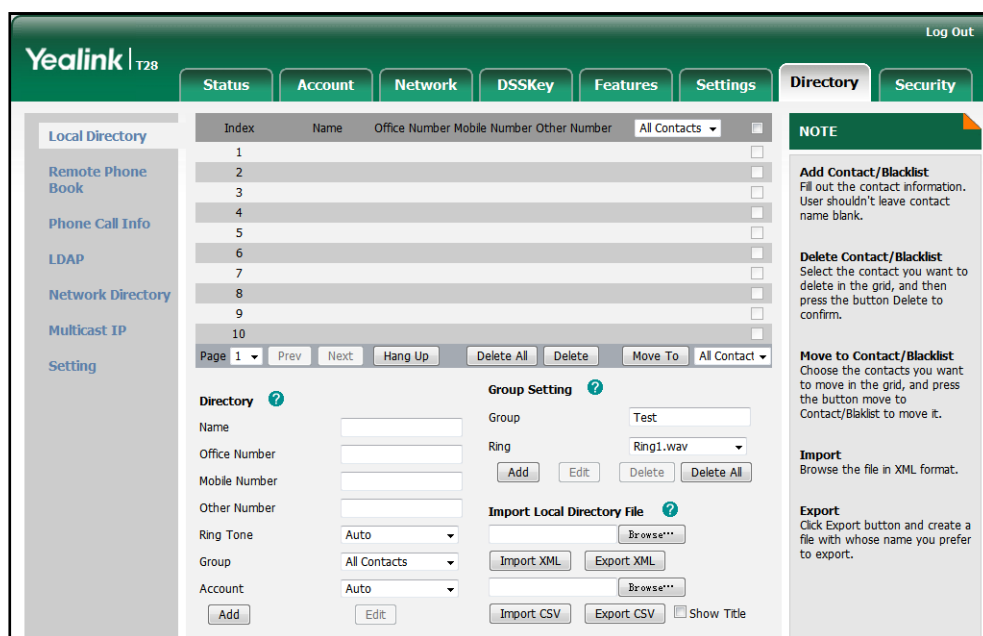

4. Click **Add** to add the group.

**To add a contact to the local directory via web user interface:**

1. Click on **Directory->Local Directory**.
2. In the **Directory** block, enter the name and the office, mobile or other numbers in the corresponding fields.
3. Select the desired ring tone from the pull-down list of **Ring Tone**.
4. Select the desired group from the pull-down list of **Group**.
5. Select the desired account from the pull-down list of **Account**.

If **Auto** is selected, the IP phone will use the first available account when placing calls to the contact from the local directory.

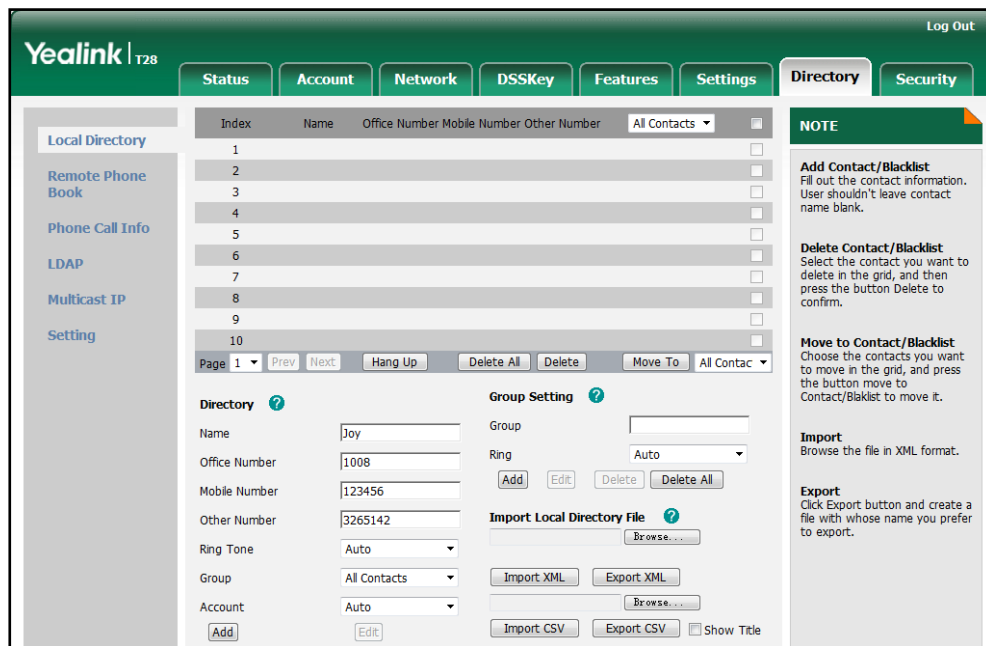

6. Click **Add** to add the contact.

#### To add a group to the local directory via phone user interface:

1. Press **Menu->Directory->Local Directory**.
2. Press the **AddGrp** soft key.
3. Enter the desired group name in the **Name** field.
4. Press **◀** or **▶**, or the **Switch** soft key to select the desired group ring tone from the **Ring Tones** field.
5. Press the **Add** soft key to accept the change.

#### To add a contact to the local directory via phone user interface:

1. Press **Menu->Directory->Local Directory**.
2. Select the desired contact group.
3. Press the **Add** soft key.
4. Enter the name and the office, mobile or other numbers in the corresponding fields.
5. Press **◀** or **▶**, or the **Switch** soft key to select the desired account from the **Account** field.

If **Auto** is selected, the IP phone will use the first available account when placing calls to the contact from the local directory.

6. Press **◀** or **▶**, or the **Switch** soft key to select the desired ring tone from the **Ring Tones** field.
7. Press the **Save** soft key to accept the change.

## Live Dialpad

Live dialpad allows IP phones to automatically dial out the entered phone number after a specified period of time.

### Procedure

Live dialpad can be configured using the configuration files or locally.

<b>Configuration File</b>	<y0000000000xx>.cfg	Configure live dialpad. For more information, refer to <a href="#">Live Dialpad</a> on page 275.
<b>Local</b>	Web User Interface	Configure live dialpad. <b>Navigate to:</b> http://<phoneIPAddress>/servlet ?p=settings-preference&q=load

To configure live dialpad via web user interface:

1. Click on **Settings->Preference**.
2. Select the desired value from the pull-down list of **Live Dialpad**.
3. Enter the desired delay time in the **Inter Digit Time (1~14s)** field.

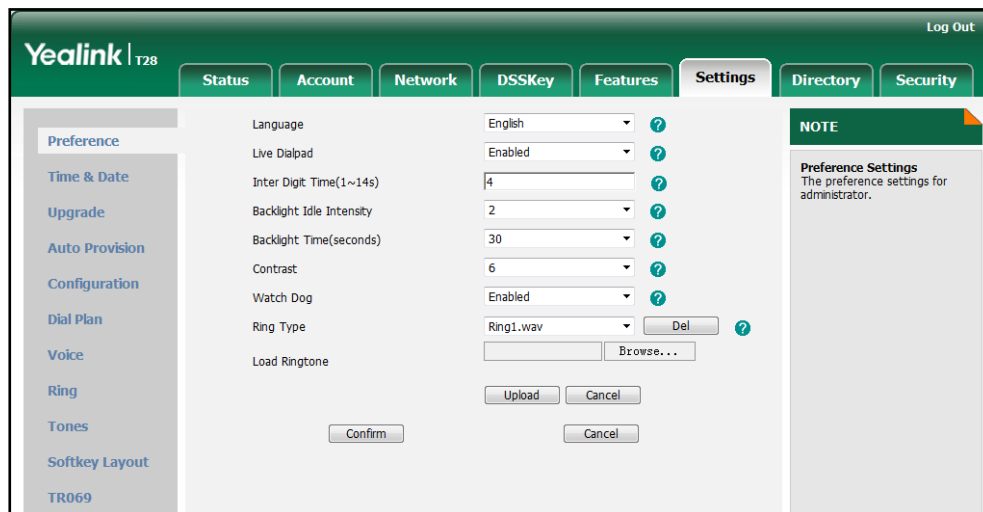

4. Click **Confirm** to accept the change.

## Call Waiting

Call waiting allows IP phones to receive a new call when there is already an active call. The new incoming call is presented to the user visually on the LCD screen. Call waiting tone allows the phone to play a short tone, to remind the user audibly of a new incoming call during conversation. Call waiting tone works only if call waiting is

enabled.

### Procedure

Call waiting and call waiting tone can be configured using the configuration files or locally.

<b>Configuration File</b>	<y0000000000xx>.cfg	Configure call waiting and call waiting tone. For more information, refer to <a href="#">Call Waiting</a> on page 276.
<b>Local</b>	Web User Interface	Configure call waiting. <b>Navigate to:</b> http://<phoneIPAddress>/servlet?p=features-general&q=load Configure call waiting tone. <b>Navigate to:</b> http://<phoneIPAddress>/servlet?p=features-audio&q=load
	Phone User Interface	Configure call waiting and call waiting tone.

**To configure call waiting via web user interface:**

1. Click on **Features->General Information**.
2. Select the desired value from the pull-down list of **Call Waiting**.
3. (Optional.) Enter the call waiting on code in the **Call Waiting On Code** field.

- (Optional.) Enter the call waiting off code in the **Call Waiting Off Code** field.

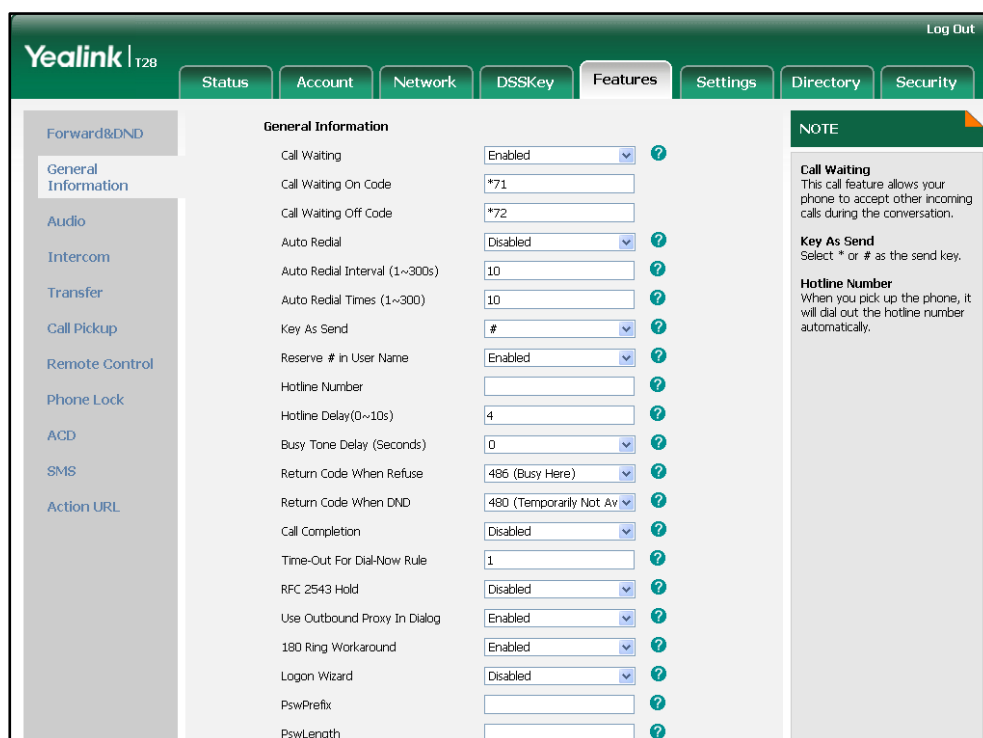

- Click **Confirm** to accept the change.

To configure call waiting tone via web user interface:

- Click on **Features->Audio**.
- Select the desired value from the pull-down list of **Call Waiting Tone**.

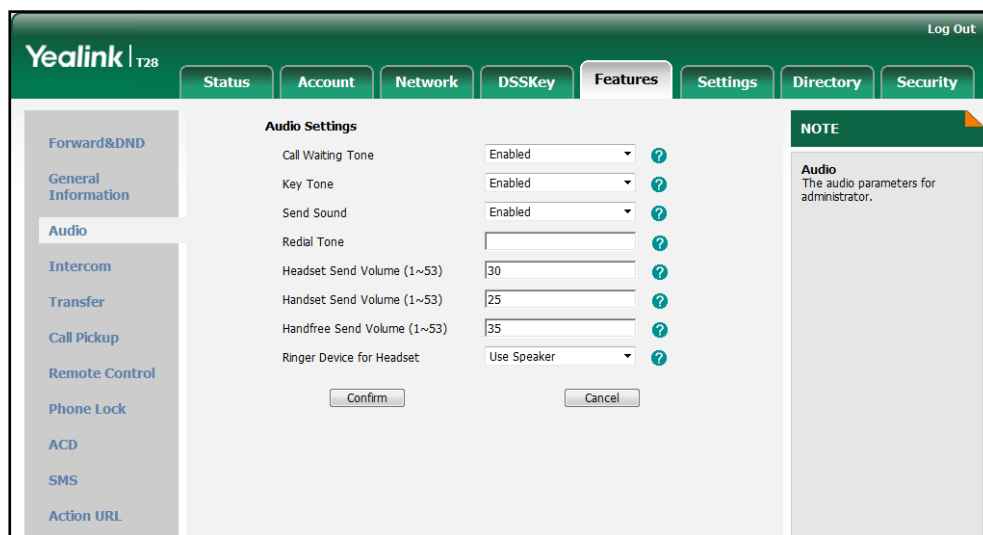

- Click **Confirm** to accept the change.

To configure call waiting and call waiting tone via phone user interface:

- Press **Menu->Features->Call Waiting**.
- Press **◀** or **▶** , or the **Switch** soft key to select the desired value from the **Call**

**Waiting** field.

3. Press ◀ or ▶, or the **Switch** soft key to select the desired value from the **Play Tone** field.
4. (Optional.) Enter the call waiting on code in the **CW On Code** field.
5. (Optional.) Enter the call waiting off code in the **CW Off Code** field.
6. Press the **Save** soft key to accept the change.

## Auto Redial

Auto redial allows IP phones to redial a busy number after the first attempt. Both the number of attempts and waiting time between redials are configurable.

### Procedure

Auto redial can be configured using the configuration files or locally.

<b>Configuration File</b>	<y0000000000xx>.cfg	Configure auto redial feature. For more information, refer to <a href="#">Auto Redial</a> on page 277.
<b>Local</b>	Web User Interface	Configure auto redial feature. <b>Navigate to:</b> http://<phoneIPAddress>/servlet ?p=features-general&q=load
	Phone User Interface	Configure auto redial feature.

**To configure auto redial via web user interface:**

1. Click on **Features->General Information**.
2. Select the desired value from the pull-down list of **Auto Redial**.
3. Enter the waiting time in the **Auto Redial Interval (1~300s)** field.

The default waiting time is 10s.

4. Enter the desired times in the **Auto Redial Times (1~300)** field.

The default value is 10.

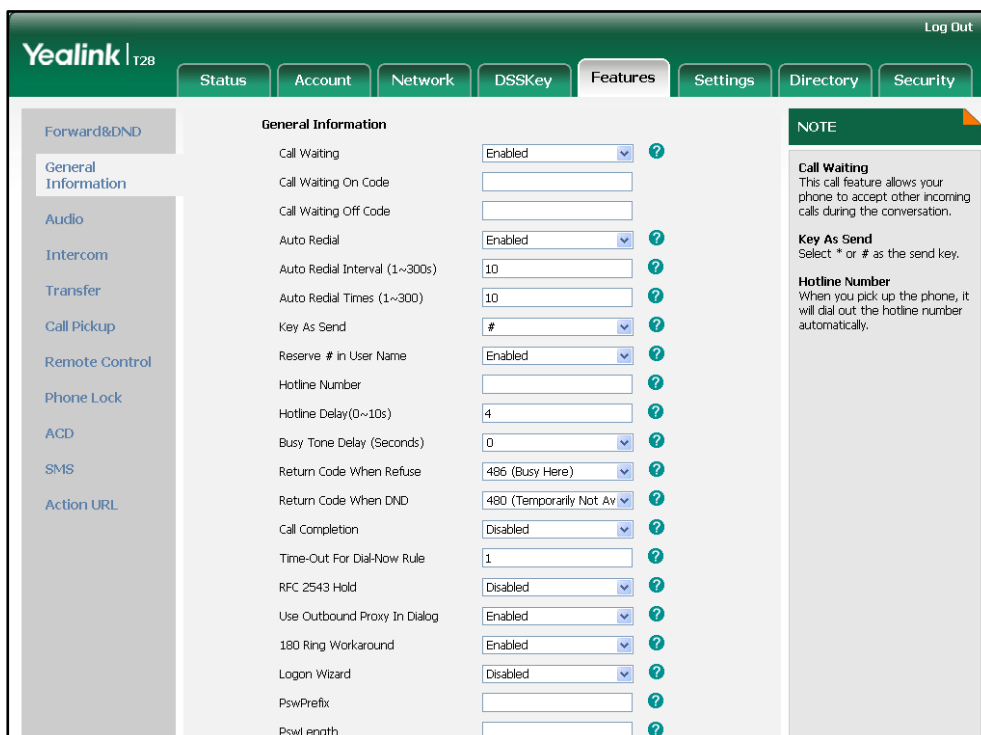

5. Click **Confirm** to accept the change.

To configure auto redial via phone user interface:

1. Press **Menu->Features->Auto Redial**.
2. Press **◀** or **▶** , or the **Switch** soft key to select the desired value from the **Auto Redial** field.
3. Enter the waiting time (in seconds) in the **Redial Interval** field.
4. Enter the desired times in the **Redial Times** field.
5. Press the **Save** soft key to accept the change.

## Auto Answer

Auto answer allows IP phones to automatically answer an incoming call. IP phones will not automatically answer the incoming call during a call even if auto answer is enabled. Auto answer is configurable on a per-line basis.

### Procedure

Auto answer can be configured using the configuration files or locally.

<b>Configuration File</b>	<MAC>.cfg	Configure auto answer. For more information, refer to <a href="#">Auto Answer</a> on page 278.
---------------------------	-----------	---



<b>Local</b>	Web User Interface	Configure auto answer. <b>Navigate to:</b> http://<phoneIPAddress>/servlet ?p=account-basic&q=load&acc =0
	Phone User Interface	Configure auto answer.

To configure auto answer via web user interface:

1. Click on **Account**.
2. Select the desired account from the pull-down list of **Account**.
3. Click on **Basic**.
4. Select the desired value from the pull-down list of **Auto-Answer**.

The screenshot shows the Yealink T28 web interface. The top navigation bar includes 'Status', 'Account', 'Network', 'DSSKey', 'Features', 'Settings', 'Directory', and 'Security'. The 'Account' tab is selected, and the 'Basic' sub-tab is active. The 'Account' dropdown is set to 'Account 1'. The 'Auto-Answer' field is set to 'Enabled'. Other fields include Proxy Require, Anonymous Call, On Code, Off Code, Anonymous Call Rejection, Missed Call Log, and Ring Type. A 'NOTE' box on the right explains the 'Basic' and 'Proxy Require' parameters.

5. Click **Confirm** to accept the change.

To configure auto answer via phone user interface:

1. Press **Menu->Settings->Advanced Settings** (password: admin) ->**Accounts**.
2. Select the desired account and then press the **Enter** soft key.
3. Press **◀** or **▶** , or the **Switch** soft key to select the desired value from the **Auto Answer** field.
4. Press the **Save** soft key to accept the change.

## Call Completion

Call completion allows users to monitor the busy party and establish a call when the busy party becomes available to receive a call. Two factors commonly prevent a call from connecting successfully:

- Callee does not answer
- Callee actively rejects the incoming call before answering

IP phones support call completion using the SUBSCRIBE/NOTIFY method, which is specified in draft-poetzi-sipping-call-completion-00, to subscribe to the busy party and receive notifications of their status changes.

## Procedure

Call completion can be configured using the configuration files or locally.

<b>Configuration File</b>	<y0000000000xx>.cfg	Configure call completion. For more information, refer to <a href="#">Call Completion</a> on page 279.
<b>Local</b>	Web User Interface	Configure call completion. <b>Navigate to:</b> http://<phoneIPAddress>/servlet ?p=features-general&q=load
	Phone User Interface	Configure call completion.

To configure call completion via web user interface:

1. Click on **Features->General Information**.
2. Select the desired value from the pull-down list of **Call Completion**.

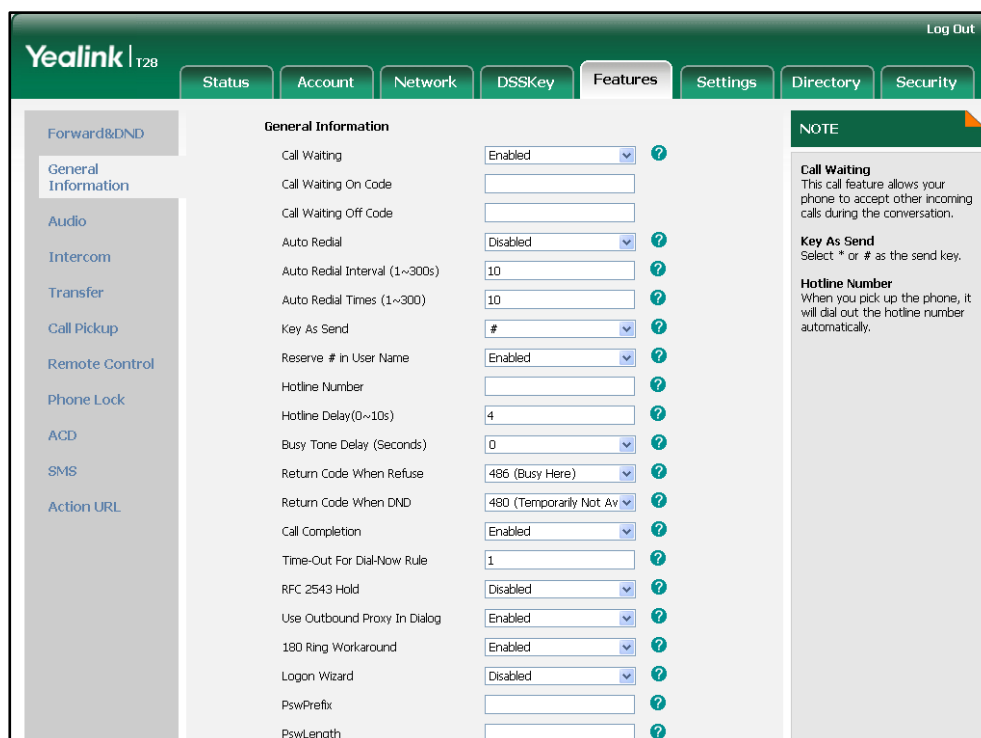

3. Click **Confirm** to accept the change.

To configure call completion via phone user interface:

1. Press **Menu->Features->Call Completion**.
2. Press **◀** or **▶** , or the **Switch** soft key to select the desired value from the **Call**

**Completion** field.

3. Press the **Save** soft key to accept the change.

## Anonymous Call

Anonymous call allows the caller to conceal the identity from the callee. The callee’s phone LCD screen prompts an incoming call from anonymity. Anonymous call is configurable on a per-line basis.

Example of anonymous SIP header:

```
Via: SIP/2.0/UDP 10.2.8.183:5063;branch=z9hG4bK1535948896
From: "Anonymous" <sip:anonymous@anonymous.invalid>;tag=128043702
To: <sip:1011@10.2.1.199>
Call-ID: 1773251036@10.2.8.183
CSeq: 1 INVITE
Contact: <sip:1012@10.2.8.183:5063>
Content-Type: application/sdp
Allow: INVITE, INFO, PRACK, ACK, BYE, CANCEL, OPTIONS, NOTIFY, REGISTER, SUBSCRIBE, REFER, PUBLISH, UPDATE, MESSAGE
Max-Forwards: 70
User-Agent: Yealink SIPT28P 2.71.0.110
Privacy: id
Supported: replaces
Allow-Events: talk,hold,conference,refer,check-sync
P-Preferred-Identity: <sip:1012@10.2.1.199>
Content-Length: 302
```

The anonymous call on code and anonymous call off code configured on IP phones are used to activate/deactivate the server-side anonymous call feature. They may vary on different servers.

### Procedure

Anonymous call can be configured using the configuration files or locally.

<b>Configuration File</b>	<MAC>.cfg	Configure anonymous call. For more information, refer to <a href="#">Anonymous Call</a> on page 279.
<b>Local</b>	Web User Interface	Configure anonymous call. <b>Navigate to:</b> http://<phoneIPAddress>/servlet ?p=account-basic&q=load&acc=0
	Phone User Interface	Configure anonymous call.

**To configure anonymous call via web user interface:**

1. Click on **Account**.
2. Select the desired account from the pull-down list of **Account**.
3. Click on **Basic**.
4. Select the desired value from the pull-down list of **Anonymous Call**.
5. (Optional.) Enter the anonymous call on code in the **On Code** field.
6. (Optional.) Enter the anonymous call off code in the **Off Code** field.

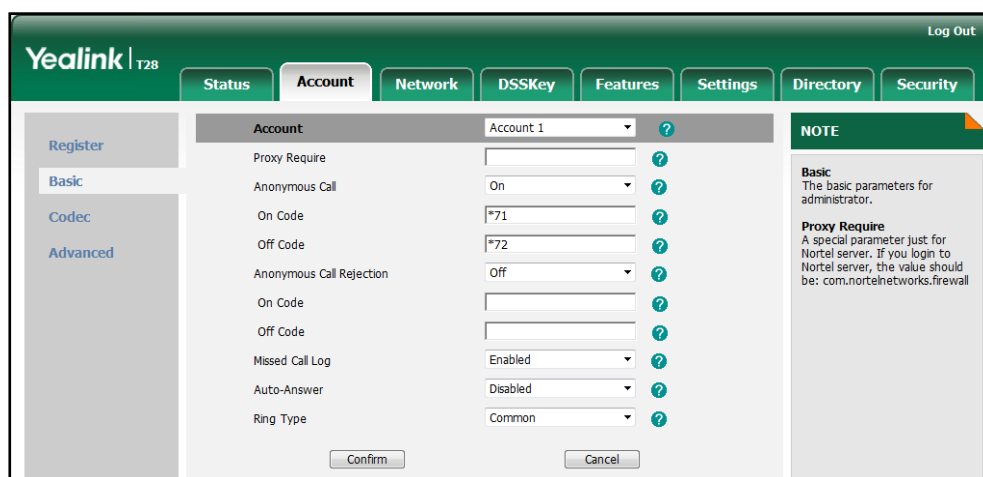

7. Click **Confirm** to accept the change.

**To configure the anonymous call via phone user interface:**

1. Press **Menu->Features->Anonymous Call**.
2. Press **◀** or **▶**, or the **Switch** soft key to select the desired line from the **Line ID** field.
3. Press **◀** or **▶**, or the **Switch** soft key to select the desired value from the **Anonymous Call** field.
4. (Optional.) Enter the anonymous call on code in the **Call On Code** field.
5. (Optional.) Enter the anonymous call off code in the **Call Off Code** field.
6. Press the **Save** soft key to accept the change.

## Anonymous Call Rejection

Anonymous call rejection allows IP phones to automatically reject incoming calls from callers whose identity has been deliberately concealed. The anonymous caller's phone LCD screen presents "Anonymity Disallowed". Anonymous call rejection is configurable on a per-line basis.

The anonymous call rejection on code and anonymous call rejection off code configured on IP phones are used to activate/deactivate the server-side anonymous call rejection feature. They may vary on different servers.

## Procedure

Anonymous call rejection can be configured using the configuration files or locally.

<b>Configuration File</b>	<MAC>.cfg	Configure anonymous call rejection. For more information, refer to <a href="#">Anonymous Call Rejection</a> on page 281.
<b>Local</b>	Web User Interface	Configure anonymous call rejection. <b>Navigate to:</b> http://<phoneIPAddress>/servlet?p=account-basic&q=load&acc=0
	Phone User Interface	Configure anonymous call rejection.

To configure anonymous call rejection via web user interface:



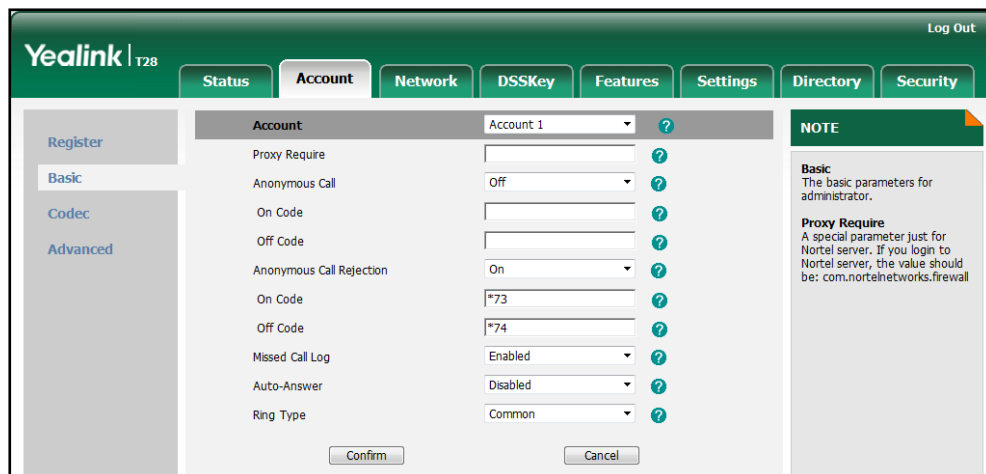

1. Click on **Account**.
2. Select the desired account from the pull-down list of **Account**.
3. Click on **Basic**.
4. Select the desired value from the pull-down list of **Anonymous Call Rejection**.
5. (Optional.) Enter the anonymous call rejection on code in the **On Code** field.
6. (Optional.) Enter the anonymous call rejection off code in the **Off Code** field.



7. Click **Confirm** to accept the change.

To configure anonymous call rejection via phone user interface:

1. Press **Menu->Features->Anonymous Call**.

2. Press  or  , or the **Switch** soft key to select the desired line from the **Line ID** field.
3. Press  or  , or the **Switch** soft key to select the desired value from the **Anonymous Rejection** field.
4. (Optional.) Enter the anonymous call rejection on code in the **Reject On Code** field.
5. (Optional.) Enter the anonymous call rejection off code in the **Reject Off Code** field.
6. Press the **Save** soft key to accept the change.

## Do Not Disturb

Do Not Disturb (DND) allows IP phones to ignore incoming calls. DND feature can be configured on a phone or a per-line basis depending on the DND mode. Two DND modes:

- **Phone** (default): DND feature is effective for the IP phone.
- **Custom**: DND feature can be configured for each or all accounts.

A user can activate or deactivate DND using the DND soft key (not applicable to the SIPT20P IP phone) or DND key. DND activated on the IP phone disables the local call forward settings. The DND configurations on IP phones may be overridden by the server settings.

The DND on code and DND off code configured on IP phones are used to activate/deactivate the server-side DND feature. They may vary on different servers.

### Return Message When DND

This feature defines the return code and the reason of the SIP response message for the rejected incoming call when DND is enabled on the IP phone. The caller’s phone LCD screen displays the received return code.

### Procedure

DND can be configured using the configuration files or locally.

<b>Configuration File</b>	<MAC>.cfg	Configure DND in the custom mode. For more information, refer to <a href="#">Do Not Disturb</a> on page 282.
	<y0000000000xx>.cfg	Assign a DND key. For more information, refer to <a href="#">DND Key</a> on page 384. Configure the DND mode. Configure DND in the phone mode.

		Specify the return code and the reason of the SIP response message when DND is enabled. For more information, refer to <a href="#">Do Not Disturb</a> on page 282.
Local	Web User Interface	Assign a DND key. <b>Navigate to:</b> http://<phoneIPAddress>/servlet?p=dsskey&q=load&model=0 Configure DND. <b>Navigate to:</b> http://<phoneIPAddress>/servlet?p=features-forward&q=load Specify the return code and the reason of the SIP response message when DND is enabled. <b>Navigate to:</b> http://<phoneIPAddress>/servlet?p=features-general&q=load
	Phone User Interface	Assign a DND key. Configure DND.

**To configure a DND key via web user interface:**

1. Click on **DSSKey->Memory Key (Line Key or Programable Key)**.
2. In the desired DSS key field, select **DND** from the pull-down list of **Type**.

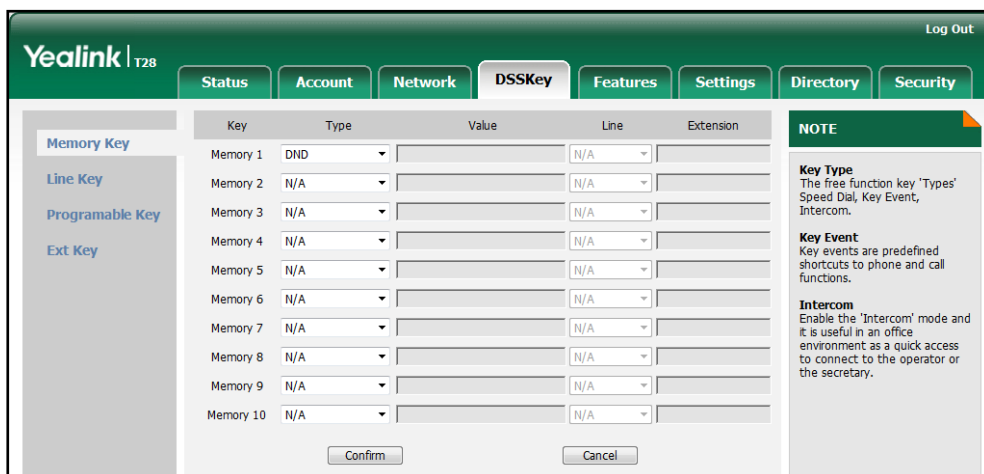

3. Click **Confirm** to accept the change.

**To configure DND feature via web user interface:**

1. Click on **Features->Forward & DND**.
2. In the **DND** block, mark the desired radio box in the **Mode** field.
  - a) If you mark the **Phone** radio box:
    - 1) Mark the desired radio box in the **DND Status** field.
    - 2) (Optional.) Enter the DND on code in the **DND On Code** field.
    - 3) (Optional.) Enter the DND off code in the **DND Off Code** field.

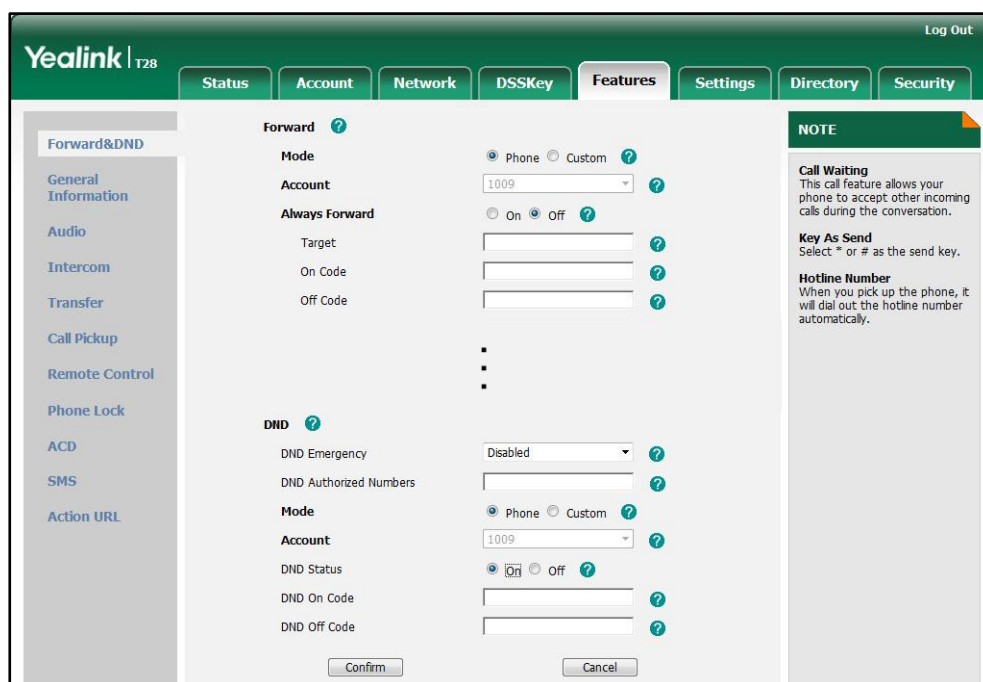

- b) If you mark the **Custom** radio box:
  - 1) Select the desired account from the pull-down list of **Account**.
  - 2) Mark the desired radio box in the **DND Status** field.
  - 3) (Optional.) Enter the DND on code in the **DND On Code** field.



4) (Optional.) Enter the DND off code in the **DND Off Code** field.

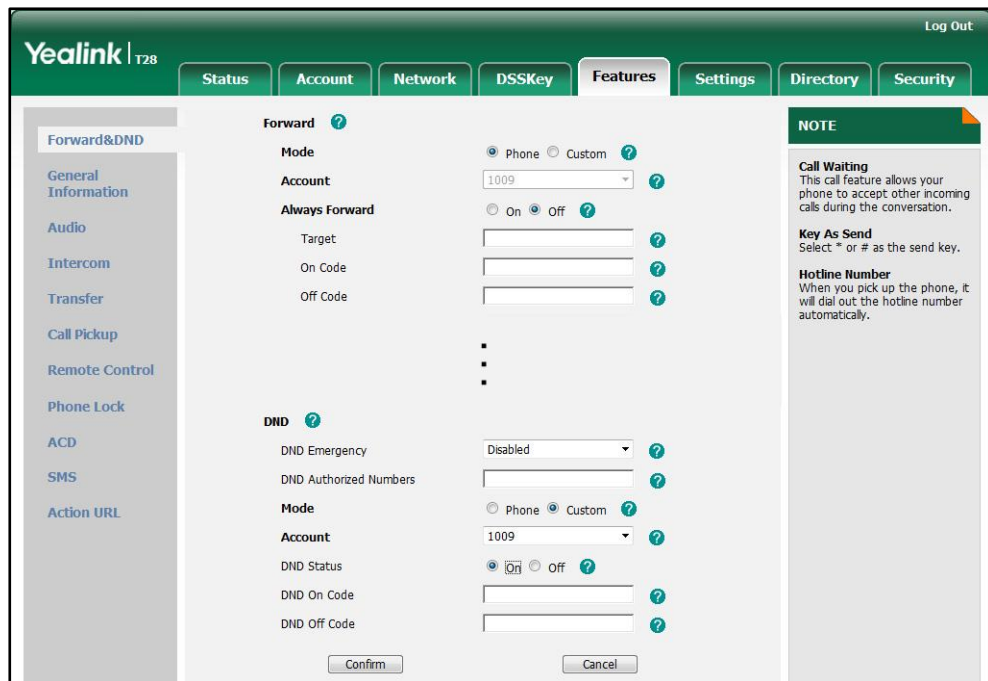

3. Click **Confirm** to accept the change.

To specify the return code and the reason when DND is enabled via web user interface:

1. Click on **Features->General Information**.
2. Select the desired type from the pull-down list of **Return Code When DND**.

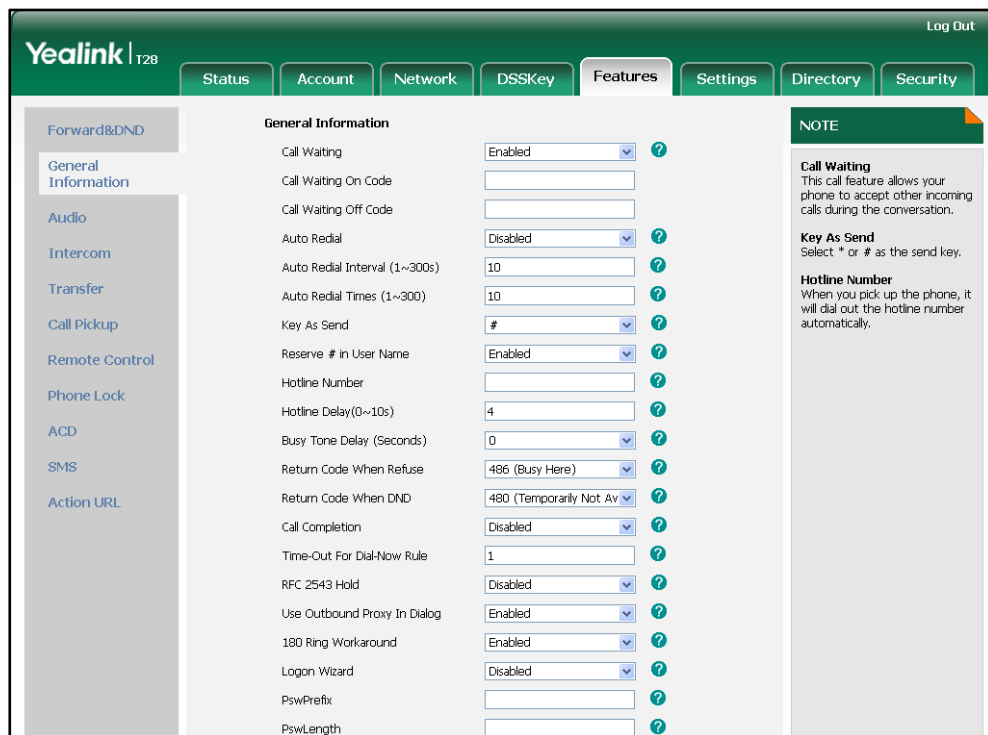

3. Click **Confirm** to accept the change.

**To configure a DND key via phone user interface:**

1. Press **Menu->Features->DSS Keys->Memory Keys** (or **Line Keys**).
2. Select the desired DSS key.
3. Press **◀** or **▶** , or the **Switch** soft key to select **Key Event** from the **Type** field.
4. Press **◀** or **▶** , or the **Switch** soft key to select **DND** from the **Key Type** field.
5. Press the **Save** soft key to accept the change.

**To configure DND in the phone mode via phone user interface:**

1. Press the **DND** soft key or the DND key when the IP phone is idle.

**To configure DND in the custom mode for a specific account via phone user interface:**

1. Press the **DND** soft key or the DND key when the IP phone is idle.  
The LCD screen displays a list of accounts registered on the IP phone.
2. Press **▲** or **▼** to select the desired account.
3. Press **◀** or **▶** soft key to select **On** to activate DND.  
You can configure DND in the custom mode for all accounts by pressing the **All On** soft key.
4. Press the **Save** soft key to accept the change.

## Busy Tone Delay

Busy tone is audible to the other party, indicating that the call connection has been broken when one party releases a call. Busy tone delay can define a period of time during which the busy tone is audible.

### Procedure

Busy tone delay can be configured using the configuration files or locally.

<b>Configuration File</b>	<y0000000000xx>.cfg	Configure busy tone delay. For more information, refer to <a href="#">Busy Tone Delay</a> on page 285.
<b>Local</b>	Web User Interface	Configure busy tone delay. <b>Navigate to:</b> http://<phoneIPAddress>/servlet ?p=features-general&q=load

**To configure busy tone delay via web user interface:**

1. Click on **Features->General Information**.

- Select the desired value from the pull-down list of **Busy Tone Delay (Seconds)**.

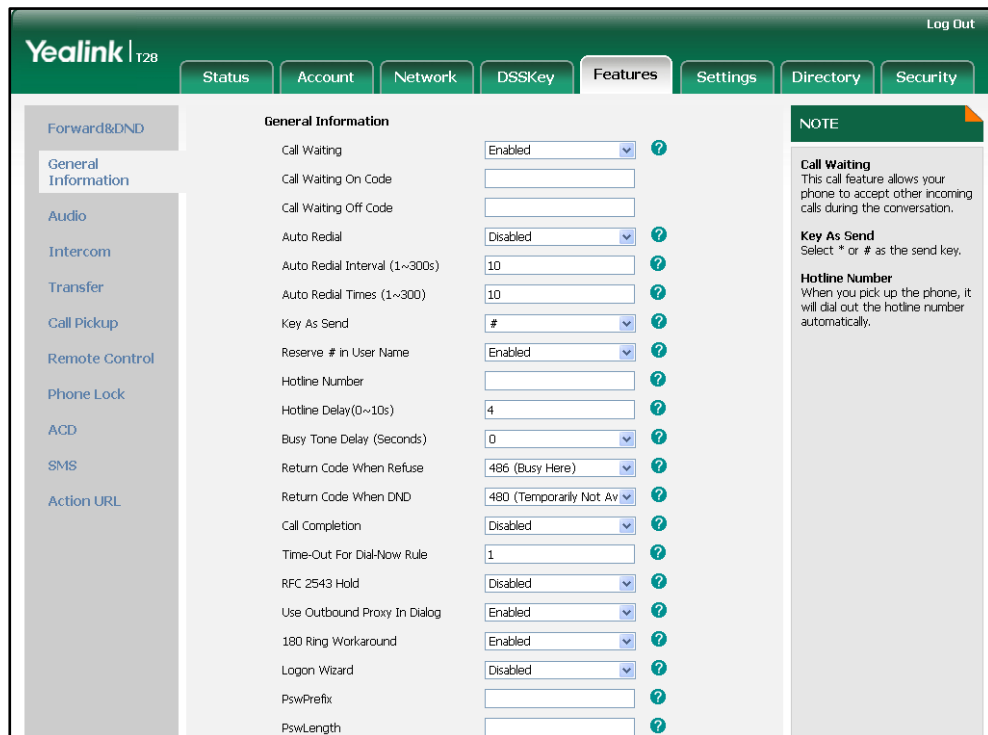

- Click **Confirm** to accept the change.

## Return Code When Refuse

Return code when refuse defines the return code and reason of the SIP response message for the refused call. The caller's LCD phone screen displays the reason according to the received return code. Available return codes and reasons are:

- 404 (Not found)
- 480 (Temporarily not available)
- 486 (Busy here)

### Procedure

Return code for refused call can be configured using the configuration files or locally.

<b>Configuration File</b>	<y0000000000xx>.cfg	Specify the return code and the reason of the SIP response message when refusing a call. For more information, refer to <a href="#">Return Code When Refuse</a> on page 285.
<b>Local</b>	Web User Interface	Specify the return code and the reason of the SIP response

		<p>message when refusing a call.</p> <p><b>Navigate to:</b>  <a href="http://&lt;phoneIPAddress&gt;/servlet?p=features-general&amp;q=load">http://&lt;phoneIPAddress&gt;/servlet?p=features-general&amp;q=load</a></p>
--	--	--

To specify the return code and the reason when refusing a call via web user interface:

1. Click on **Features->General Information**.
2. Select the desired value from the pull-down list of **Return Code When Refuse**.

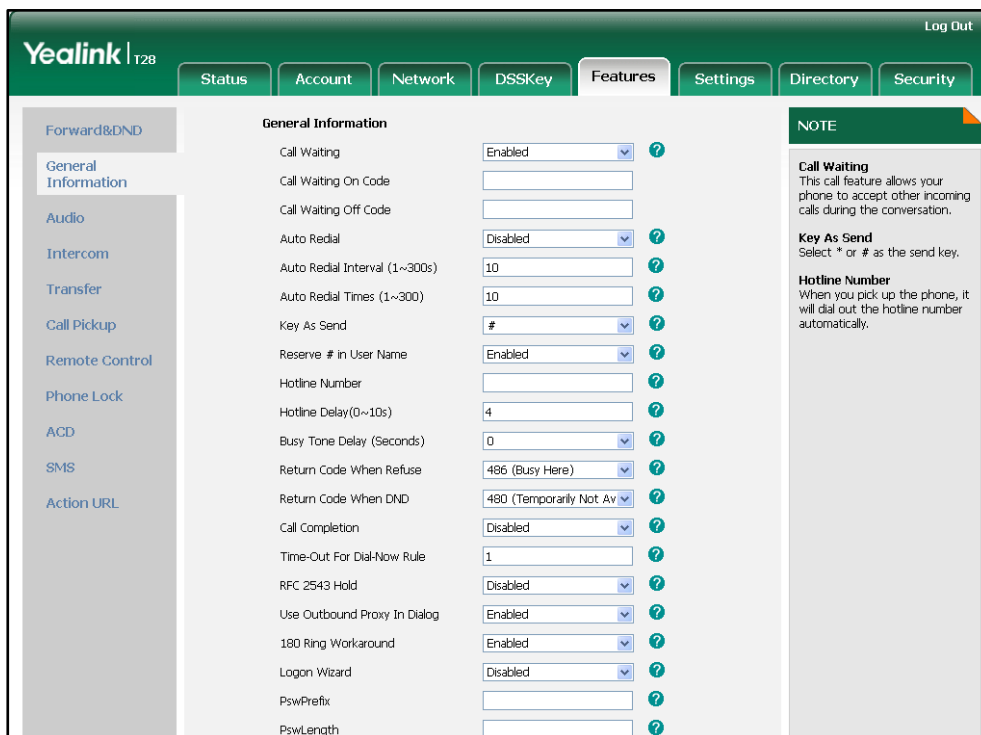

3. Click **Confirm** to accept the change.

## Early Media

Early media refers to media (e.g., audio and video) played to the caller before a SIP call is actually established. Current implementation supports early media through the 183 message. When the caller receives a 183 message with SDP before the call is established, a media channel is established. This channel is used to provide the early media stream to the caller.

## 180 Ring Workaround

180 ring workaround defines whether to deal with the 180 message received after the 183 message. When the caller receives a 183 message, it suppresses any local ringback tone and begins to play the media received. 180 ring workaround allows IP phones to resume and play the local ringback tone upon a subsequent 180 message received.

## Procedure

180 ring workaround can be configured using the configuration files or locally.

<b>Configuration File</b>	<y0000000000xx>.cfg	Configure 180 ring workaround. For more information, refer to <a href="#">180 Ring Workaround</a> on page 286.
<b>Local</b>	Web User Interface	Configur 180 ring workaround. <b>Navigate to:</b> http://<phoneIPAddress>/servlet ?p=features-general&q=load

To configure 180 ring workaround via web user interface:

1. Click on **Features->General Information**.
2. Select the desired value from the pull-down list of **180 Ring Workaround**.

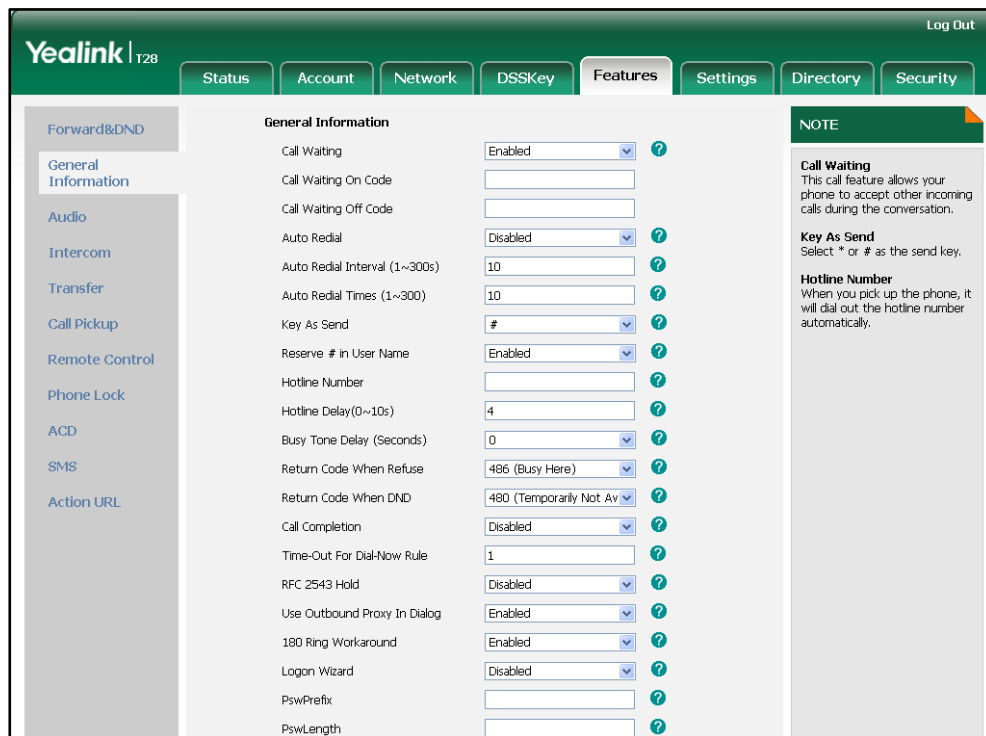

3. Click **Confirm** to accept the change.

## Use Outbound Proxy in Dialog

An outbound proxy server can receive all initiating request messages and route them to the designated destination. If the IP phone is configured to use an outbound proxy server within a dialog, all SIP request messages from the IP phone will be forced to send to the outbound proxy server.

**Note** To use this feature, make sure the outbound server have been correctly configured on the IP phone.

### Procedure

Use outbound proxy in dialog can be configured using the configuration files or locally.

<b>Configuration File</b>	<y0000000000xx>.cfg	Specify whether to use outbound proxy in a dialog. For more information, refer to <a href="#">Use Outbound Proxy in Dialog</a> on page 286.
<b>Local</b>	Web User Interface	Specify whether to use outbound proxy in a dialog. <b>Navigate to:</b> http://<phoneIPAddress>/servlet?p=features-general&q=load

To specify whether to use outbound proxy server in a dialog via web user interface:

1. Click on **Features->General Information**.

- Select the desired value from the pull-down list of **Use Outbound Proxy In Dialog**.

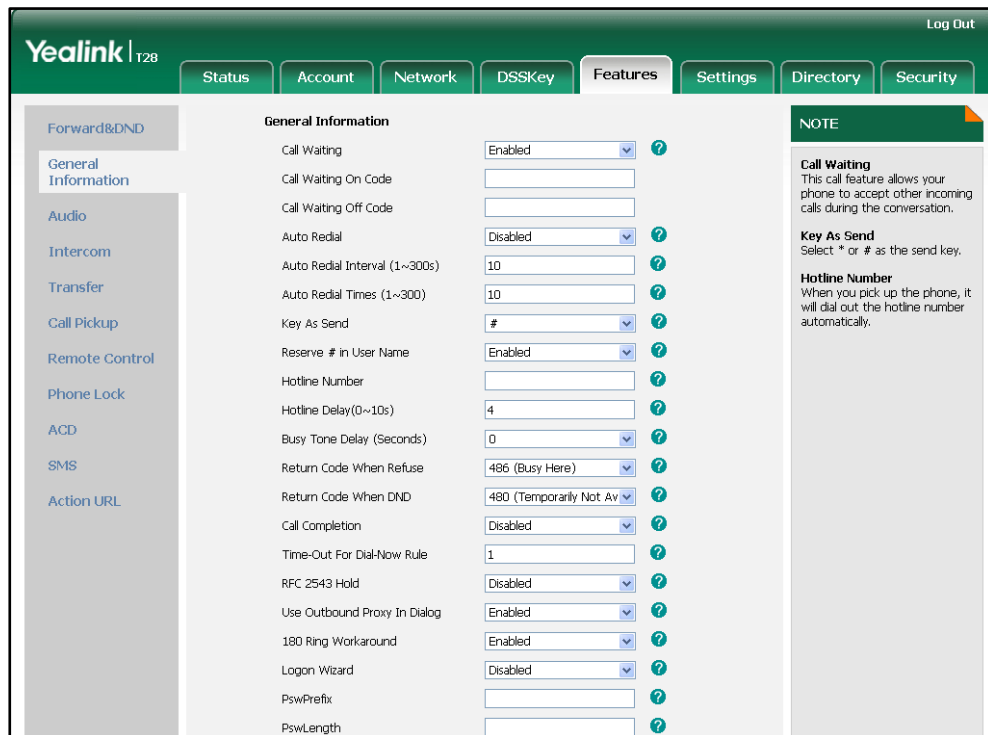

- Click **Confirm** to accept the change.

## SIP Session Timer

SIP session timers T1, T2 and T4 are SIP transaction layer timers defined in RFC 3261. Timer T1 is an estimate of the Round Trip Time (RTT) of transactions between a SIP client and SIP server. Timer T2 represents the maximum retransmitting time of any SIP request message. The retransmitting and doubling of T1 will continue until the retransmitting time reaches the T2 value. Timer T4 represents the time the network will take to clear messages between the SIP client and server. These session timers are configurable on IP phones.

### Procedure

SIP session timer can be configured using the configuration files or locally.

<b>Configuration File</b>	<MAC>.cfg	Configure SIP session timer. For more information, refer to <a href="#">SIP Session Timer</a> on page 287.
<b>Local</b>	Web User Interface	Configure SIP session timer. <b>Navigate to:</b> http://<phoneIPAddress>/servlet ?p=account-adv&q=load&acc=0

**To configure session timer via web user interface:**

1. Click on **Account**.
2. Select the desired account from the pull-down list of **Account**.
3. Click on **Advanced**.
4. Enter the desired value in the **SIP Session Timer T1 (0.5~10s)** field.  
The default value is 0.5s.
5. Enter the desired value in the **SIP Session Timer T2 (2~40s)** field.  
The default value is 4s.
6. Enter the desired value in the **SIP Session Timer T4 (2.5~60s)** field.  
The default value is 5s.

Parameter	Value
Account	Account 1
Keep Alive Type	Default
Keep Alive Interval ( Seconds )	30
Local SIP Port	5060
RPort	Disabled
SIP Session Timer T1 (0.5~10s)	0.5
SIP Session Timer T2 (2~40s)	4
SIP Session Timer T4 (2.5~60s)	5
Subscribe Period ( Seconds )	1800
DTMF Type	RFC2833
DTMF Info Type	DTMF-Relay
DTMF Payload Type(96~255)	101
Retransmission	Disabled
Subscribe for MWI	Disabled
MWI Subscription Period(Seconds)	3600
Subscribe MWI To Voice Mail	Disabled
Voice Mail	
Caller ID Source	FROM
Session Timer	Disabled
Session Expires(30~7200s)	1800
Session Refresher	UAC
Send user=phone	Disabled

7. Click **Confirm** to accept the change.

## Session Timer

Session timer allows for a periodic refresh of SIP sessions through a re-INVITE request, to determine whether a SIP session is still active. Session timer is specified in RFC 4028. IP phones support two refresher modes: UAC and UAS. The UAC mode means refreshing the session from the client, while the UAS mode means refreshing the session from the server. The session expiration and session refresher are negotiated via the Session-Expires header in the INVITE message. The negotiated refresher will send a re-INVITE/UPDATE request at or before the negotiated session expiration.



## Procedure

Session timer can be configured using the configuration files or locally.

<b>Configuration File</b>	<MAC>.cfg	Configure session timer. For more information, refer to <a href="#">Session Timer</a> on page 288.
<b>Local</b>	Web User Interface	Configure session timer. <b>Navigate to:</b> http://<phoneIPAddress>/servlet ?p=account-adv&q=load&acc= 0

To configure session timer via web user interface:

1. Click on **Account**.
2. Select the desired account from the pull-down list of **Account**.
3. Click on **Advanced**.
4. Select the desired value from the pull-down list of **Session Timer**.
5. Enter the desired time interval in the **Session Expires (30~7200s)** field.
6. Select the desired refresher from the pull-down list of **Session Refresher**.

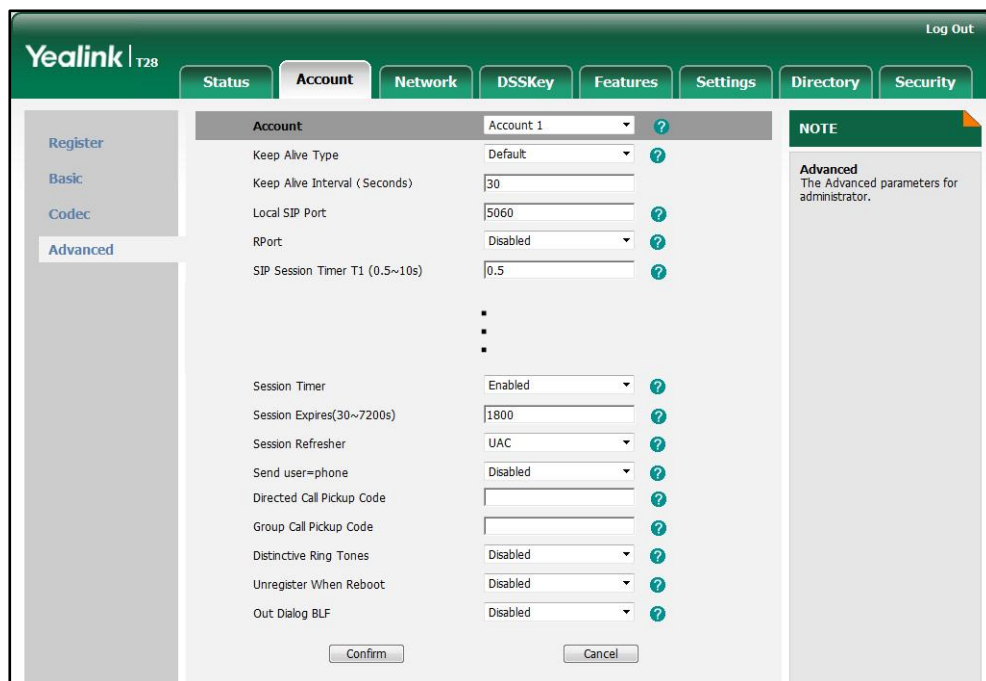

7. Click **Confirm** to accept the change.

## Call Hold

Call hold provides a service of placing an active call on hold. When a call is placed on hold, the IP phone sends an INVITE request with a HOLD SDP to the server. IP phones support two call hold methods, one is RFC 3264, which sets the "a" (media attribute) in the SDP to sendonly, recvonly or inactive (e.g., a=sendonly). The other is RFC 2543, which sets the "c" (connection addresses for the media streams) in the SDP to zero (e.g., c=0.0.0.0). Call hold tone allows IP phones to play a hold tone at regular intervals when there is a call on hold.

### Procedure

Call hold can be configured using the configuration files or locally.

<p><b>Configuration File</b></p>	<p>&lt;y0000000000xx&gt;.cfg</p>	<p>Configure the call hold tone and call hold tone delay.</p> <p>Specify whether RFC 2543 (c=0.0.0.0) outgoing hold signaling is used.</p> <p>For more information, refer to <a href="#">Call Hold</a> on page 289.</p>
<p><b>Local</b></p>	<p>Web User Interface</p>	<p>Configure the call hold tone and call hold tone delay.</p> <p>Specify whether RFC 2543 (c=0.0.0.0) outgoing hold signaling is used.</p> <p><b>Navigate to:</b></p> <p>http://&lt;phoneIPAddress&gt;/servlet?p=features-general&amp;q=load</p>

**To configure call hold method via web user interface:**

1. Click on **Features->General Information**.

2. Select the desired value from the pull-down list of **RFC 2543 Hold**.

The screenshot shows the Yealink T28 web interface. The 'Features' tab is selected, and the 'General Information' section is active. The 'RFC 2543 Hold' field is currently set to 'Disabled'. Other fields include 'Call Waiting' (Enabled), 'Auto Redial' (Disabled), and 'Key As Send' (#). A 'NOTE' box on the right explains 'Call Waiting', 'Key As Send', and 'Hotline Number'.

3. Click **Confirm** to accept the change.

To configure call hold tone and call hold tone delay via web user interface:

1. Click on **Features->General Information**.
2. Select the desired value from the pull-down list of **Play Hold Tone**.
3. Enter the desired time in the **Play Hold Tone Delay** field.

The screenshot shows the Yealink T28 web interface. The 'Features' tab is selected, and the 'General Information' section is active. The 'Play Hold Tone' field is now set to 'Enabled' and the 'Play Hold Tone Delay' field is set to '30'. The 'RFC 2543 Hold' field remains 'Disabled'. A 'Confirm' button is visible at the bottom of the form.

4. Click **Confirm** to accept the change.

## Call Forward

Call forward allows users to redirect an incoming call to a third party. IP phones redirect an incoming INVITE message by responding with a 302 Moved Temporarily message, which contains a Contact header with a new URI that should be tried. Three types of call forward:

- **Always Forward** -- Forward the incoming call immediately.
- **Busy Forward** -- Forward the incoming call when the callee is busy.
- **No Answer Forward** -- Forward the incoming call after a period of ring time.

Call forward can be configured on a phone or a per-line basis depending on the call forward mode. The following describes the call forward modes:

- **Phone** (default): Call forward feature is effective for the IP phone.
- **Custom**: Call forward feature can be configured for each or all accounts.

The call forward on code and call forward off code configured on IP phones are used to activate/deactivate the server-side call forward feature. They may vary on different servers.

### Forward International

Forward international allows users to forward an incoming call to an international telephone number. This feature is enabled by default.

### Procedure

Call forward can be configured using the configuration files or locally.

<b>Configuration File</b>	<MAC>.cfg	<p>Configure call forward in custom mode.</p> <p>For more information, refer to <a href="#">Call Forward</a> on page 291.</p>
	<y0000000000xx>.cfg	<p>Configure the call forward mode.</p> <p>Configure call forward in phone mode.</p> <p>Configure forward international.</p> <p>For more information, refer to <a href="#">Call Forward</a> on page 291.</p>

<b>Local</b>	Web User Interface	<p>Configure call forward.</p> <p><b>Navigate to:</b></p> <p>http://&lt;phoneIPAddress&gt;/servlet?p=features-forward&amp;q=load</p> <p>Configure forward international.</p> <p><b>Navigate to:</b></p> <p>http://&lt;phoneIPAddress&gt;/servlet?p=features-general&amp;q=load</p>
	Phone User Interface	Configure call forward.

**To configure call forward via web user interface:**

1. Click on **Features->Forward & DND**.
2. In the **Forward** block, mark the desired radio box in the **Mode** field.
  - a) If you mark the **Phone** radio box:
    - 1) Mark the desired radio box in the **Always/Busy/No Answer Forward** field.
    - 2) Enter the destination number you want to forward in the **Target** field.
    - 3) (Optional.) Enter the on code and off code in the **On Code** and **Off Code** fields.
    - 4) Select the ring time to wait before forwarding from the pull-down list of **After Ring Times** (only for the no answer forward).

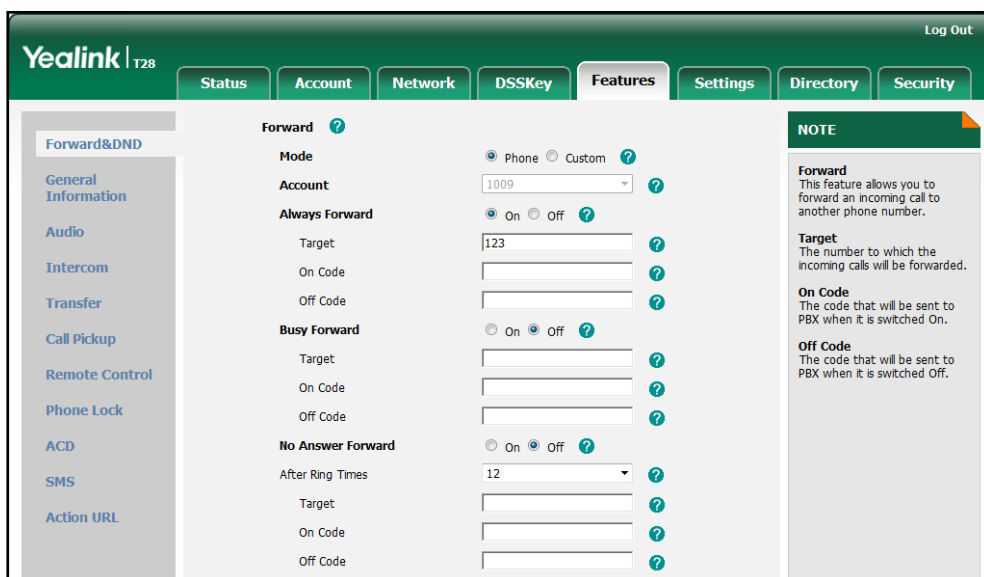

- b) If you mark the **Custom** radio box:
  - 1) Select the desired account from the pull-down list of **Account**.
  - 2) Mark the desired radio box in the **Always/Busy/No Answer Forward** field.

- 2) Enter the destination number you want to forward in the **Target** field.
- 3) Enter the on code and off code in the **On Code** and **Off Code** fields.
- 4) Select the ring time to wait before forwarding from the pull-down list of **After Ring Times** (only for the no answer forward).

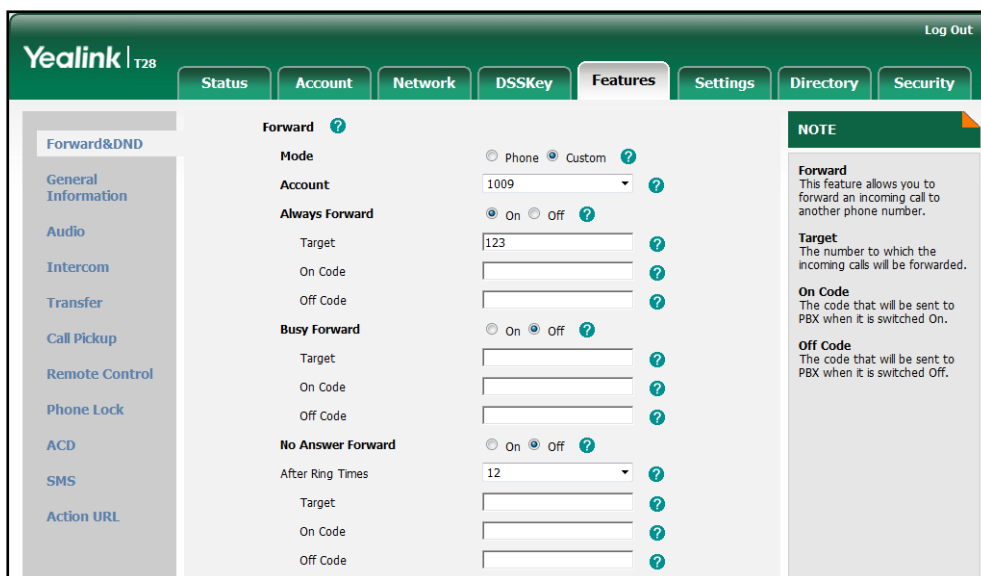

3. Click **Confirm** to accept the change.





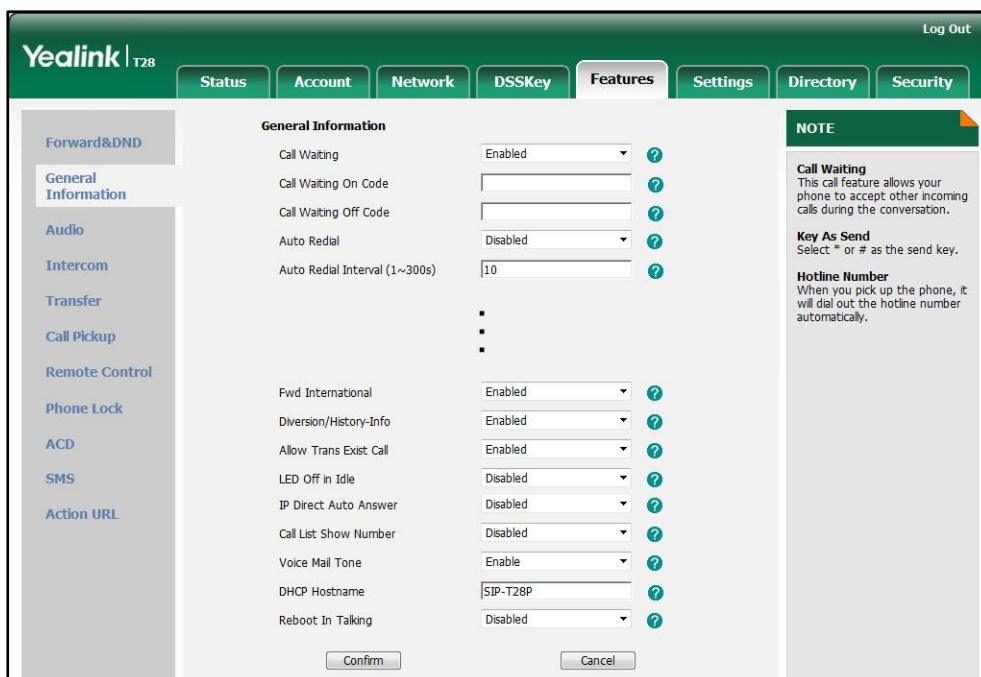





To configure forward international via web user interface:

1. Click on **Features->General Information**.
2. Select the desired value from the pull-down list of **Fwd International**.









3. Click **Confirm** to accept the change.

**To configure call forward in phone mode via phone user interface:**

1. Press **Menu->Features->Call Forward**.
2. Press  or  to select the desired forwarding type, and then press the **Enter** soft key.
3. Depending on your selection:
  - a) If you select **Always Forward**:
    - 1) Press  or  , or the **Switch** soft key to select the desired value from the **Always** field.
    - 2) Enter the destination number you want to forward all incoming calls to in the **Forward To** field.
    - 3) (Optional.) Enter the always forward on code and off code respectively in the **On Code** and **Off Code** fields.
  - b) If you select **Busy Forward**:
    - 1) Press  or  , or the **Switch** soft key to select the desired value from the **Busy** field.
    - 2) Enter the destination number you want to forward all incoming calls to when the IP phone is busy in the **Forward To** field.
    - 3) (Optional.) Enter the busy forward on code and off code respectively in the **On Code** and **Off Code** fields.
  - c) If you select **No Answer Forward**:
    - 1) Press  or  , or the **Switch** soft key to select the desired value from the **No Answer** field.
    - 2) Enter the destination number you want to forward all unanswered incoming calls to in the **Forward To** field.
    - 3) Press  or  , or the **Switch** soft key to select the ring time to wait before forwarding from the **After Ring Time** field.  
The default ring time is 12 seconds.
    - 4) (Optional.) Enter the no answer forward on code and off code respectively in the **On Code** and **Off Code** fields.
4. Press the **Save** soft key to accept the change.



**To configure call forward in custom mode via phone user interface:**

1. Press **Menu->Features->Call Forward**.
2. Press  or  to select the desired account, and then press the **Enter** soft key.
3. Press  or  to select the desired forwarding type, and then press the **Enter** soft key.
4. Depending on your selection:
  - a) If you select **Always Forward**, you can configure it for a specific account.
    - 1) Press  or  , or the **Switch** soft key to select the desired value from the



**Always** field.

- 2) Enter the destination number you want to forward all incoming calls to in the **Forward To** field.
- 3) (Optional.) Enter the always forward on code and off code respectively in the **On Code** and **Off Code** fields.



You can also configure the always forward for all accounts. After the always forward was configured for a specific account, do the following:

- 1) Press  or  to highlight the **Always** field.
- 2) Press the **All Lines** soft key.





The LCD screen prompts "Copy to All Lines?".

- 3) Press the **OK** soft key to accept the change.
- b) If you select **Busy Forward**, you can configure it for a specific account.
- 1) Press  or  , or the **Switch** soft key to select the desired value from the **Busy** field.
  - 2) Enter the destination number you want to forward all incoming calls to when the IP phone is busy in the **Forward To** field.
  - 3) (Optional.) Enter the busy forward on code and off code respectively in the **On Code** and **Off Code** fields.



You can also configure the busy forward for all accounts. After the busy forward was configured for a specific account, do the following:

- 1) Press  or  to highlight the **Busy** field.
- 2) Press the **All Lines** soft key.

The LCD screen prompts "Copy to All Lines?".

- 3) Press the **OK** soft key to accept the change.
- c) If you select **No Answer Forward**, you can configure it for a specific account.
- 1) Press  or  , or the **Switch** soft key to select the desired value from the **No Answer** field.
  - 2) Enter the destination number you want to forward all unanswered incoming calls to in the **Forward To** field.
  - 3) Press  or  , or the **Switch** soft key to select the ring time to wait before forwarding from the **After Ring Time** field  
The default ring time is 12 seconds.
  - 4) (Optional.) Enter the no answer forward on code and off code respectively in the **On Code** and **Off Code** fields.

You can also configure the no answer forward for all accounts. After the no answer forward was configured for a specific account, do the following:

- 1) Press  or  to highlight the **No Answer** field.
- 2) Press the **All Lines** soft key.

The LCD screen prompts "Copy to All Lines?".



- 3) Press the **OK** soft key to accept the change.
5. Press the **Save** soft key to accept the change.

## Call Transfer

Call transfer enables IP phones to transfer an existing call to another party. IP phones support call transfer using the REFER method specified in RFC 3515 and offer three types of transfer:

- **Blind Transfer** -- Transfer a call directly to another party without consulting. Blind transfer is implemented by a simple REFER method without Replaces in the Refer-To header.
- **Semi-attended Transfer** -- Transfer a call after hearing the ringback tone. Semi-attended transfer is implemented by a REFER method with Replaces in the Refer-To header.
- **Attended Transfer** -- Transfer a call with prior consulting. Attended transfer is implemented by a REFER method with Replaces in the Refer-To header.

Normally, call transfer is completed by pressing the transfer key. Blind transfer on hook and semi-attended transfer on hook features allow the IP phone to complete the transfer through on-hook.

When a user performs a semi-attended transfer, semi-attended transfer feature determines whether to display the prompt "**n New Missed Call(s)**" ("n" indicates the number of the missed calls) on the destination party's phone LCD screen.

### Procedure

Call transfer can be configured using the configuration files or locally.

<b>Configuration File</b>	<y0000000000xx>.cfg	Specify whether to complete the transfer through on-hook. Configure semi-attended transfer feature. For more information, refer to <a href="#">Call Transfer</a> on page 300.
<b>Local</b>	Web User Interface	Specify whether to complete the transfer through on-hook. Configure semi-attended transfer feature. <b>Navigate to:</b> http://<phoneIPAddress>/servlet?p=features-transfer&q=load

To configure call transfer via web user interface:

1. Click on **Features**->**Transfer**.
2. Select the desired values from the pull-down lists of **Semi-Attend Transfer**, **Blind Transfer On Hook** and **Semi Attend Transfer On Hook**.

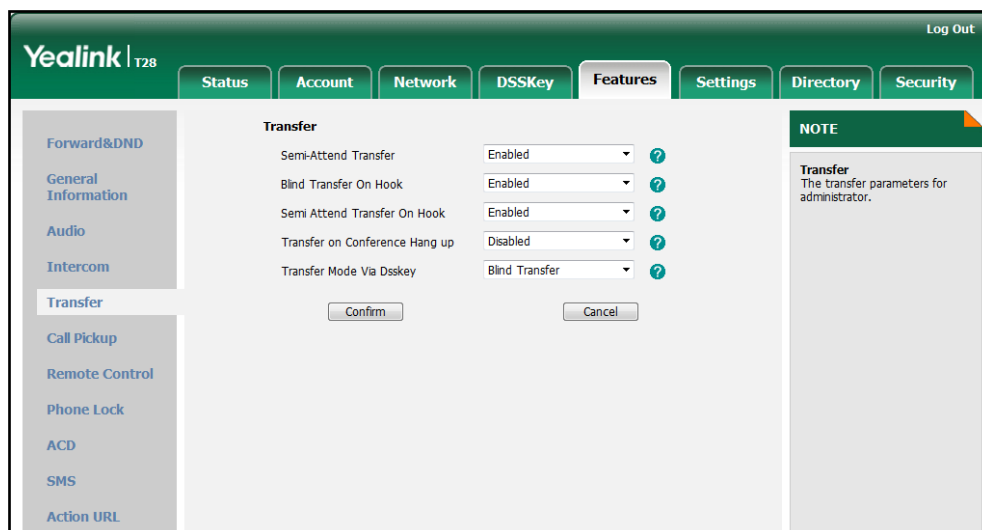

3. Click **Confirm** to accept the change.

## Network Conference

Network conference, also known as centralized conference, provides users with flexibility of call with multiple participants (more than three). IP phones implement network conference using the REFER method specified in RFC 4579. This feature depends on support from a SIP server.

### Procedure

Network conference can be configured using the configuration files or locally.

<b>Configuration File</b>	<MAC>.cfg	Configure network conference. For more information, refer to <a href="#">Network Conference</a> on page 301.
<b>Local</b>	Web User Interface	Configure network conference. <b>Navigate to:</b> http://<phoneIPAddress>/servlet?p=account-adv&q=load&acc=0

To configure the network conference via web user interface:

1. Click on **Account**.

2. Select the desired account from the pull-down list of **Account**.
3. Click on **Advanced**.
4. Select **Network Conference** from the pull-down list of **Conference Type**.
5. Enter the conference URI in the **Conference URI** field.

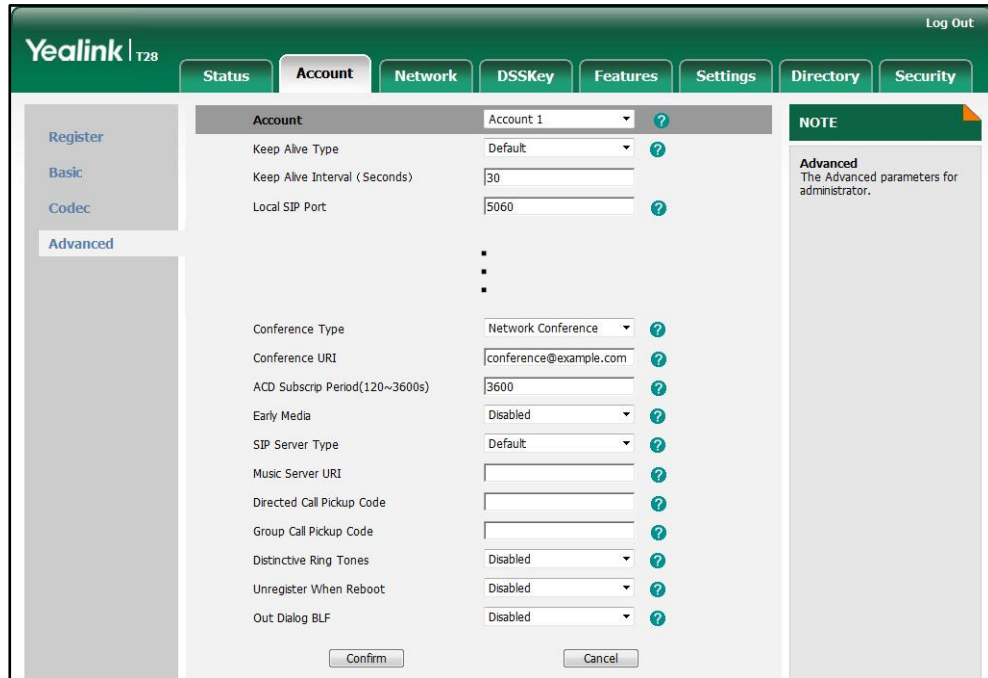

6. Click **Confirm** to accept the change.

## Transfer on Conference Hang Up

For local conference, all parties drop the call when the conference initiator drops the conference call. Transfer on conference hang up allows the other two parties remain connected when the conference initiator drops the conference call.

### Procedure

Transfer on conference hang up can be configured using the configuration files or locally.

<b>Configuration File</b>	<y0000000000xx>.cfg	Configure the transfer on conference hang up. For more information, refer to <a href="#">Transfer on Conference Hang Up</a> on page 302.
<b>Local</b>	Web User Interface	Configure the transfer on conference hang up. <b>Navigate to:</b>

		http://<phoneIPAddress>/servlet ?p=features-transfer&q=load
--	--	--

To configure Transfer on Conference Hang up via web user interface:

1. Click on **Features->Transfer**.
2. Select the desired value from the pull-down list of **Transfer on Conference Hang up**.

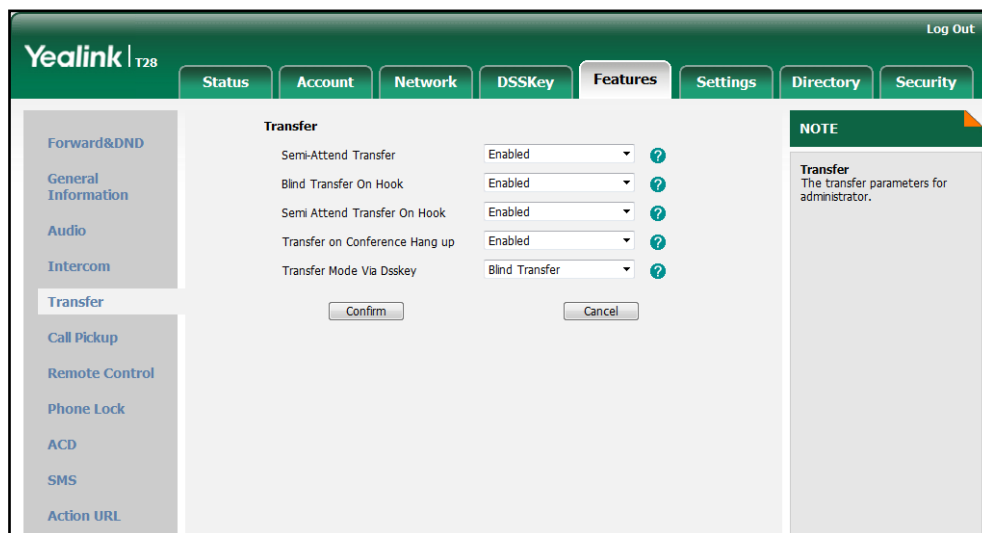

3. Click **Confirm** to accept the change.

## Directed Call Pickup

Directed call pickup is used for picking up an incoming call on a specific extension. A user can pick up the incoming call using a directed pickup key or the DPickup soft key (not applicable to the SIP-T20P IP phone). This feature depends on support from a SIP server. For many SIP servers, directed call pickup requires a directed pickup code, which can be configured on a phone or a per-line basis.

**Note** It is recommended not to configure the directed call pickup key and the DPickup soft key simultaneously. If you do, the directed call pickup key will not be used correctly.

### Procedure

Directed call pickup can be configured using the configuration files or locally.

<b>Configuration File</b>	<MAC>.cfg	Configure the directed call pickup code on a per-line basis. For more information, refer to <a href="#">Directed Call Pickup</a> on page 302.
---------------------------	-----------	---

	<y0000000000xx>.cfg	<p>Assign a directed call pickup key.</p> <p>For more information, refer to <a href="#">Directed Call Pickup Key</a> on page 384.</p> <p>Configure directed call pickup feature on a phone basis.</p> <p>For more information, refer to <a href="#">Directed Call Pickup</a> on page 302.</p>
Local	Web User Interface	<p>Assign a directed call pickup key.</p> <p><b>Navigate to:</b>  <a href="http://&lt;phoneIPAddress&gt;/servlet?p=dsskey&amp;q=load&amp;model=0">http://&lt;phoneIPAddress&gt;/servlet?p=dsskey&amp;q=load&amp;model=0</a></p> <p>Configure directed call pickup feature on a phone basis.</p> <p><b>Navigate to:</b>  <a href="http://&lt;phoneIPAddress&gt;/servlet?p=features-callpickup&amp;q=load">http://&lt;phoneIPAddress&gt;/servlet?p=features-callpickup&amp;q=load</a></p> <p>Configure directed call pickup code on a per-line basis.</p> <p><b>Navigate to:</b>  <a href="http://&lt;phoneIPAddress&gt;/servlet?p=account-adv&amp;q=load&amp;acc=0">http://&lt;phoneIPAddress&gt;/servlet?p=account-adv&amp;q=load&amp;acc=0</a></p>
	Phone User Interface	<p>Assign a directed call pickup key.</p>

**To configure a directed call pickup key via web user interface:**

1. Click on **DSSKey->Memory Key (Line Key or Programable Key)**.
2. In the desired DSS key field, select **Directed Pickup** from the pull-down list of **Type**.
3. Enter the directed call pickup code followed by the specific extension in the **Value** field.

4. Select the desired line from the pull-down list of **Line**.

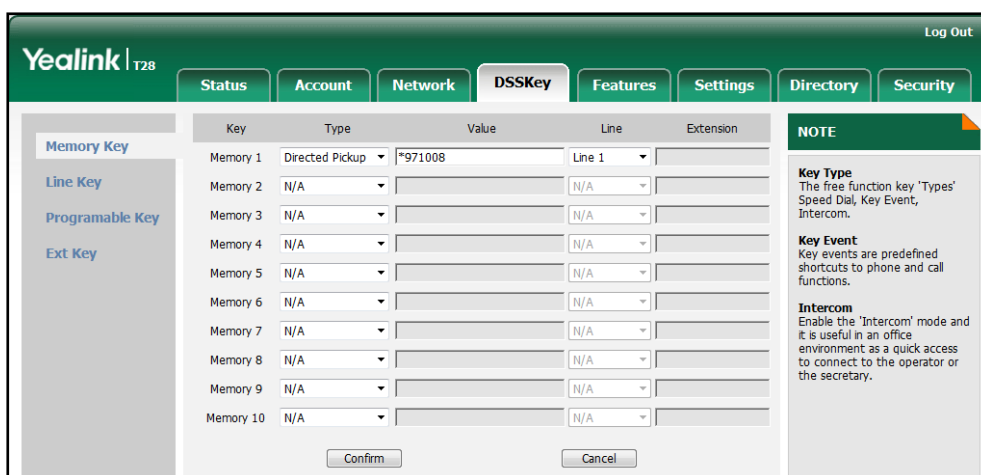

5. Click **Confirm** to accept the change.

To configure directed call pickup feature on a phone basis via web user interface (not applicable to the SIP-T20P IP phone):

1. Click on **Features->Call Pickup**.
2. Select the desired value from the pull-down list of **Directed Call Pickup**.
3. Enter the directed call pickup code in the **Directed Call Pickup Code** field.

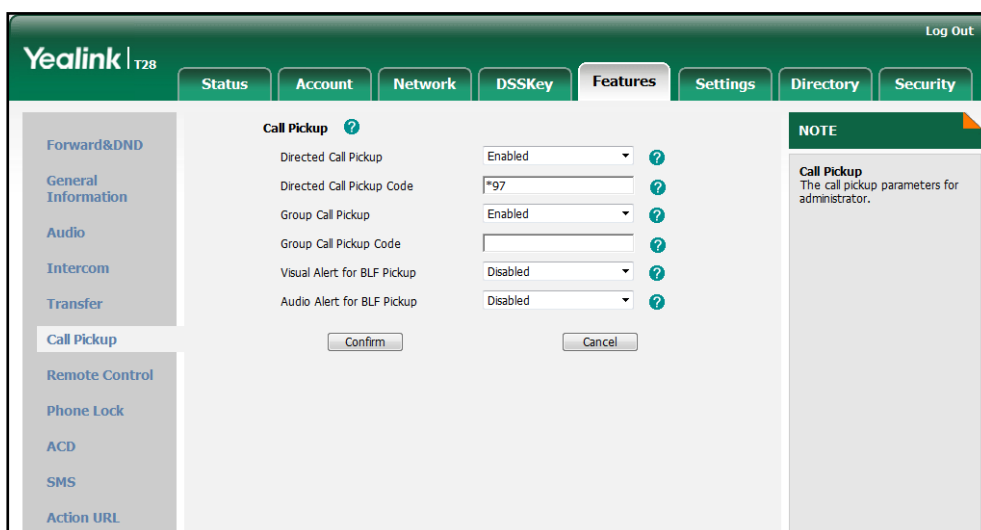

4. Click **Confirm** to accept the change.

To configure the directed call pickup code on a per-line basis via web user interface (not applicable to the SIP-T20P IP phone):

1. Click on **Account**.
2. Select the desired account from the pull-down list of **Account**.
3. Click on **Advanced**.

- Enter the directed call pickup code in the **Directed Call Pickup Code** field.

The screenshot shows the Yealink T28 web interface with the 'Account' tab selected. The 'Advanced' sub-tab is active. The 'Directed Call Pickup Code' field is set to '\*97'. Other configuration options include 'Keep Alive Type' (Default), 'Keep Alive Interval (Seconds)' (30), 'Local SIP Port' (5060), 'RPort' (Disabled), 'SIP Session Timer T1 (0.5~10s)' (0.5), 'SIP Session Timer T2 (2~40s)' (4), 'SIP Session Timer T4 (2.5~60s)' (5), and 'Subscribe Period (Seconds)' (1800). There are also fields for 'Music Server URI', 'Group Call Pickup Code', 'Distinctive Ring Tones', 'Unregister When Reboot', and 'Out Dialog BLF', all currently set to 'Disabled'. A 'NOTE' box on the right states: 'Advanced: The Advanced parameters for administrator.' Buttons for 'Confirm' and 'Cancel' are at the bottom.

- Click **Confirm** to accept the change.

To configure a directed pickup key via phone user interface:

- Press **Menu->Features->DSS Keys->Memory Keys (or Line Keys)**.
- Select the desired DSS key.
- Press **◀** or **▶**, or the **Switch** soft key to select **Key Event** from the **Type** field.
- Press **◀** or **▶**, or the **Switch** soft key to select **Direct Pickup** from the **Key Type** field.
- Press **◀** or **▶**, or the **Switch** soft key to select the desired line from the **Account ID** field.
- Enter the directed call pickup code followed by the specific extension in the **Value** field.
- Press the **Save** soft key to accept the change.

## Group Call Pickup

Group call pickup is used for picking up incoming calls within a pre-defined group. If the group receives many incoming calls at once, the user will pick up the first incoming call, using a group pickup key or the GPickup soft key (not applicable to the SIP-T20P IP phone). This feature depends on support from a SIP server. For many SIP servers, group call pickup requires a group pickup code, which can be configured on a phone or a per-line basis.

## Procedure

Group call pickup can be configured using the configuration files or locally.

<b>Configuration File</b>	<MAC>.cfg	<p>Configure the group call pickup code on a per-line basis.</p> <p>For more information, refer to <a href="#">Group Call Pickup</a> on page 304.</p>
	<y0000000000xx>.cfg	<p>Assign a group call pickup key.</p> <p>For more information, refer to <a href="#">Group Call Pickup Key</a> on page 386.</p> <p>Configure group call pickup feature on a phone basis.</p> <p>For more information, refer to <a href="#">Group Call Pickup</a> on page 304.</p>
<b>Local</b>	Web User Interface	<p>Assign a group call pickup key.</p> <p><b>Navigate to:</b></p> <p>http://&lt;phoneIPAddress&gt;/servlet?p=dsskey&amp;q=load&amp;model=0</p> <p>Configure group call pickup feature on a phone basis.</p> <p><b>Navigate to:</b></p> <p>http://&lt;phoneIPAddress&gt;/servlet?p=features-callpickup&amp;q=load</p> <p>Configure the group call pickup code on a per-line basis.</p> <p><b>Navigate to:</b></p> <p>http://&lt;phoneIPAddress&gt;/servlet?p=account-adv&amp;q=load&amp;acc=0</p>
	Phone User Interface	<p>Assign a group call pickup key.</p>

**To configure a group call pickup key via web user interface:**

1. Click on **DSSKey->Memory Key (Line Key or Programable Key)**.
2. In the desired DSS key field, select **Group Pickup** from the pull-down list of **Type**.
3. Enter the group call pickup code in the **Value** field.



4. Select the desired line from the pull-down list of **Line**.

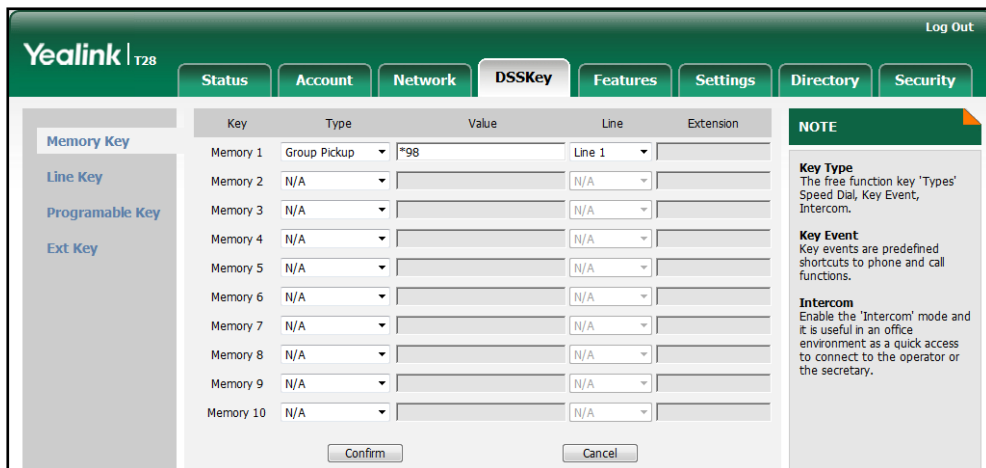

5. Click **Confirm** to accept the change.

To configure group call pickup feature on a phone basis via web user interface (not applicable to the SIP-T20P IP phone):

1. Click on **Features->Call Pickup**.
2. Select the desired value from the pull-down list of **Group Call Pickup**.
3. Enter the group call pickup code in the **Group Call Pickup Code** field.

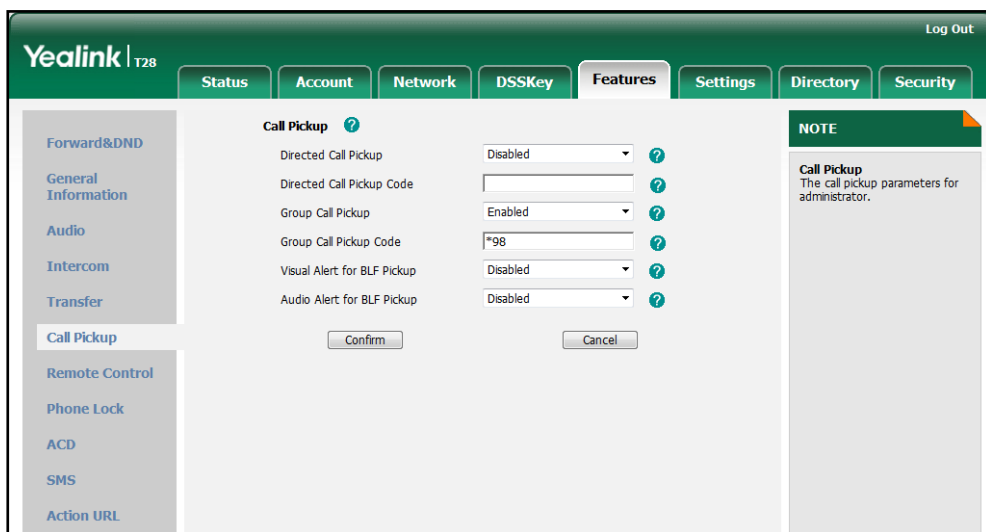

4. Click **Confirm** to accept the change.

To configure the group call pickup code on a per-line basis via web user interface (not applicable to the SIP-T20P IP phone):

1. Click on **Account**.
2. Select the desired account from the pull-down list of **Account**.
3. Click on **Advanced**.

4. Enter the group call pickup code in the **Group Call Pickup Code** field.

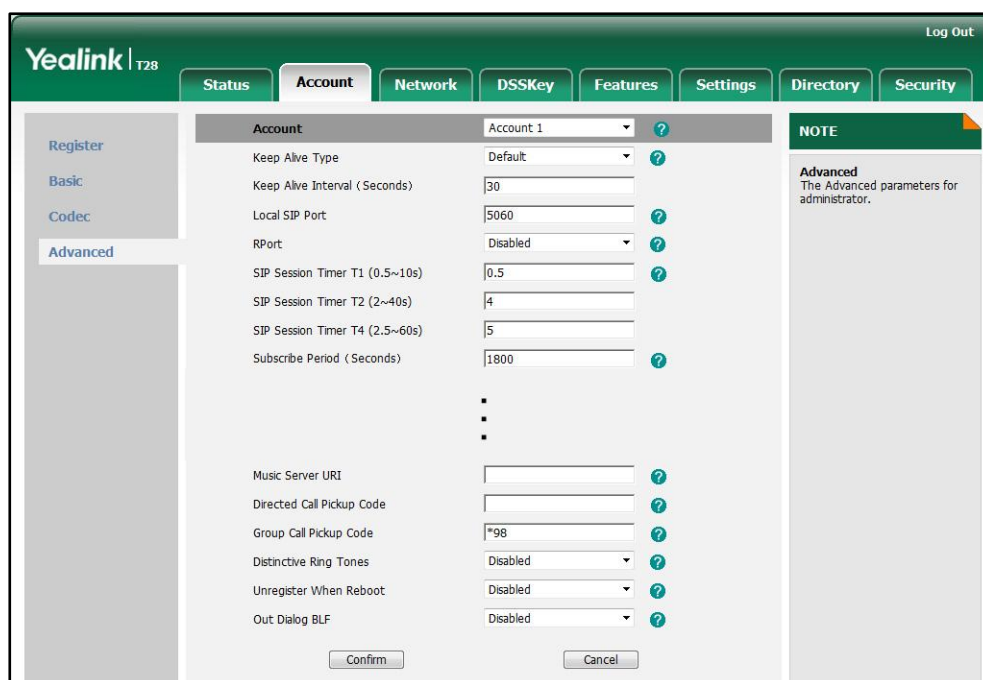

5. Click **Confirm** to accept the change.

To configure a group pickup key via phone user interface:

1. Press **Menu->Features->DSS Keys->Memory Keys** (or **Line Keys**).
2. Select the desired DSS key.
3. Press **◀** or **▶**, or the **Switch** soft key to select **Key Event** from the **Type** field.
4. Press **◀** or **▶**, or the **Switch** soft key to select **Group Pickup** from the **Key Type** field.
5. Press **◀** or **▶**, or the **Switch** soft key to select the desired line from the **Account ID** field.
6. Enter the group call pickup code in the **Value** field.
7. Press the **Save** soft key to accept the change.

## Dialog Info Call Pickup

Call pickup is implemented through SIP signals on some specific servers. IP phones support to pick up incoming calls via a NOTIFY message with dialog-info event. A user can pick up an incoming call by pressing the DSS key used to monitor a specific extension (such as the BLF key). This feature is not applicable to the SIP-T19P IP phone.

Example of the dialog-info message carried in NOTIFY message:

```
<?xml version="1.0"?>
<dialog-info xmlns="urn:ietf:params:xml:ns:dialog-info" version="6" state="full"
entity="sip:1013@10.2.1.199">
<dialog id="706655206@10.2.8.213" call-id="706655206@10.2.8.213" local-tag="827932784"
remote-tag="1887460740" direction="recipient">
<state>early</state>
<local>
<identity>sip:1013@10.2.1.199</identity>
<target uri="sip:1013@10.2.1.199">
</target>
</local>
<remote>
<identity>sip:1011@10.2.1.199</identity>
<target uri="sip:1011@10.2.8.213:5063">
</target>
</remote>
</dialog>
</dialog-info>
```

### Procedure

Dialog info call pickup can be configured using the configuration files or locally.

<b>Configuration File</b>	<MAC>.cfg	Configure dialog info call pickup. For more information, refer to <a href="#">Dialog Info Call Pickup</a> on page 305.
<b>Local</b>	Web User Interface	Configure dialog info call pickup. <b>Navigate to:</b> http://<phoneIPAddress>/servl et?p=account-adv&q=load&ac c=0

To configure dialog info call pickup via web user interface:

1. Click on **Account**.
2. Select the desired account from the pull-down list of **Account**.
3. Click on **Advanced**.

4. Select the desired value from the pull-down list of **Dialog Info Call Pickup**.

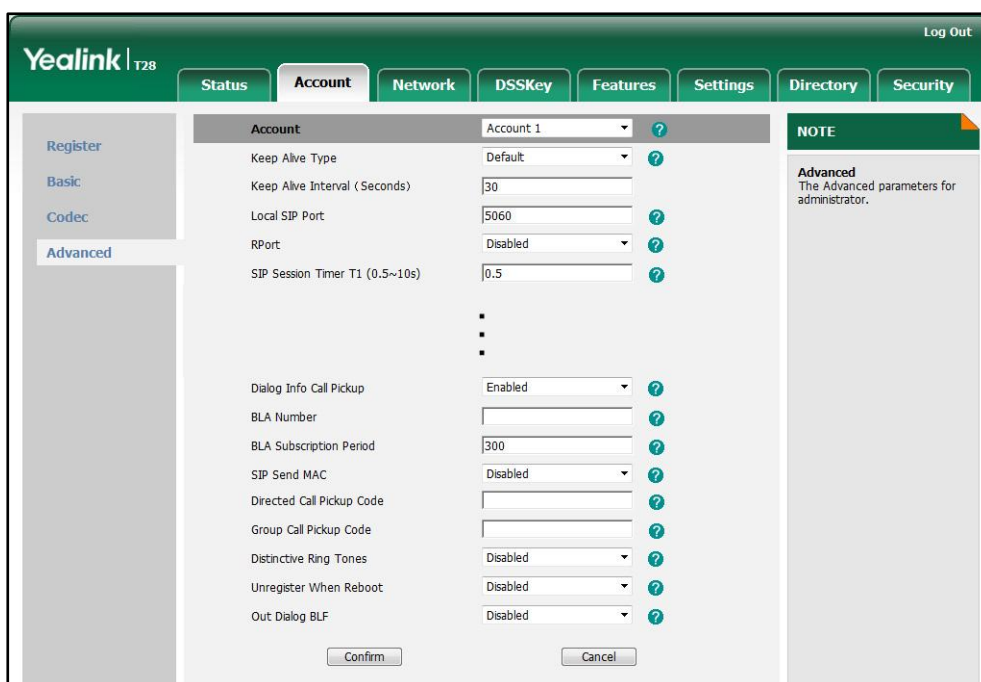

5. Click **Confirm** to accept the change.

## Call Return

Call return, also known as last call return, allows users to place a call back to the last caller. Call return is implemented on IP phones using a call return key.

### Procedure

Call return key can be configured using the configuration files or locally.

<b>Configuration File</b>	<y0000000000xx>.cfg	Assign a call return key. For more information, refer to <a href="#">Call Return Key</a> on page 388.
<b>Local</b>	Web User Interface	Assign a call return key. <b>Navigate to:</b> http://<phoneIPAddress>/servlet ?p=dsskey&q=load&model=0
	Phone User Interface	Assign a call return key.

**To configure a call return key via web user interface:**

1. Click on **DSSKey->Memory Key (Line Key or Programmable Key)**.

- In the desired DSS key field, select **Call Return** from the pull-down list of **Type**.

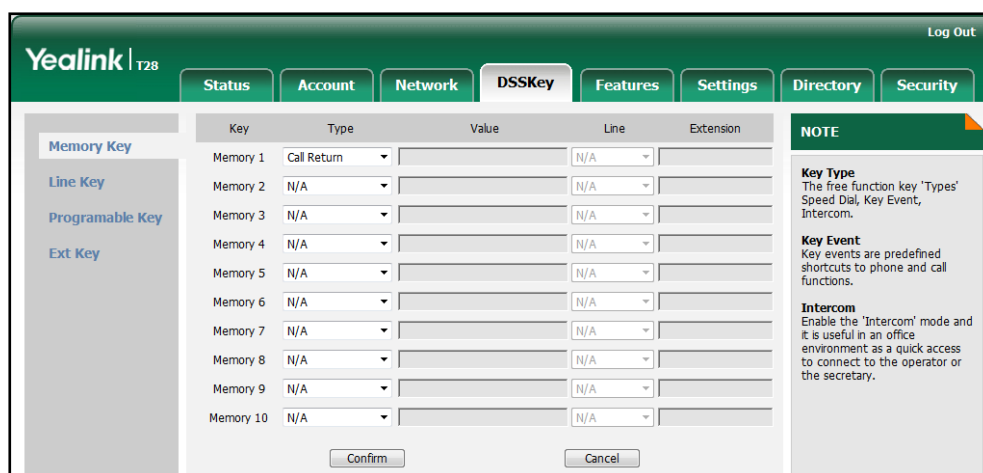

- Click **Confirm** to accept the change.

To configure a call return key via phone user interface:

- Press **Menu->Features->DSS Keys->Memory Keys** (or **Line Keys**).
- Select the desired DSS key.
- Press **◀** or **▶**, or the **Switch** soft key to select **Key Event** from the **Type** field.
- Press **◀** or **▶**, or the **Switch** soft key to select **Call Return** from the **Key Type** field.
- Press the **Save** soft key to accept the change.

## Call Park

Call park allows users to park a call on a special extension and then retrieve it on any other phone in the system. Users can park calls on the extension, known as call park orbit, by pressing a call park key. The current call is placed on hold and can be retrieved on another IP phone. This feature depends on support from a SIP server.

### Note

The SIP-T19P IP phone supports call park feature for BroadSoft server only. For more information, refer to *Yealink IP Phones Deployment Guide for BroadWorks Environments*.

### Procedure

Call park key can be configured using the configuration files or locally.

<b>Configuration File</b>	<y0000000000xx>.cfg	Assign a call park key. For more information, refer to <a href="#">Call Park Key</a> on page 388.
---------------------------	---------------------	--

<b>Local</b>	Web User Interface	Assign a call park key.  <b>Navigate to:</b> http://<phoneIPAddress>/servlet?p=dsskey&q=load&model=0
	Phone User Interface	Assign a call park key.

**To configure a call park key via web user interface:**

1. Click on **DSSKey->Memory Key (or Line Key)**.
2. In the desired memory key (or line key) field, select **Call Park** from the pull-down list of **Type**.
3. Enter the desired value (e.g., call park feature code) in the **Value** field.
4. Select the desired line from the pull-down list of **Line**.

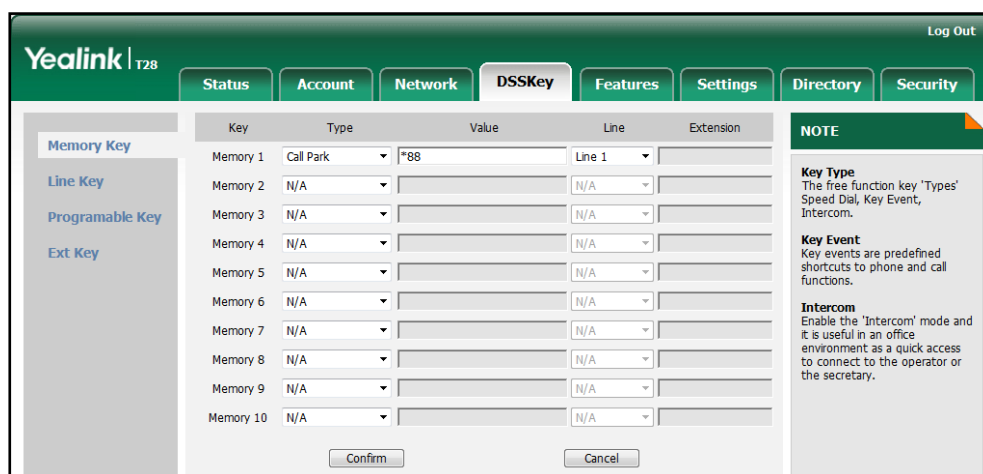

5. Click **Confirm** to accept the change.

**To configure a call park key via phone user interface:**

1. Press **Menu->Features->DSS Keys->Memory Keys (or Line Keys)**.
2. Select the desired DSS key.
3. Press **←** or **→**, or the **Switch** soft key to select **Key Event** from the **Type** field.
4. Press **←** or **→**, or the **Switch** soft key to select **Call Park** from the **Key Type** field.
5. Press **←** or **→**, or the **Switch** soft key to select the desired line from the **Account ID** field.
6. Enter the desired value (e.g., call park feature code) in the **Value** field.
7. Press the **Save** soft key to accept the change.

## Web Server Type

Web server type determines access protocol of the IP phone's web user interface. IP phones support both HTTP and HTTPS protocols for accessing the web user interface. HTTP is an application protocol that runs on top of the TCP/IP suite of protocols. HTTPS is a web protocol that encrypts and decrypts user page requests as well as pages returned by the web server. Both the HTTP and HTTPS port numbers are configurable.

### Procedure

Web server type can be configured using the configuration files or locally.

<b>Configuration File</b>	<y0000000000xx>.cfg	Configure the web access type, HTTP port and HTTPS port. For more information, refer to <a href="#">Web Server Type</a> on page 305.
<b>Local</b>	Web User Interface	Configure the web access type, HTTP port and HTTPS port. <b>Navigate to:</b> http://<phoneIPAddress>/servlet?p=network-adv&q=load
	Phone User Interface	Configure the web access type, HTTP port and HTTPS port.

**To configure web server type via web user interface:**

1. Click on **Network->Advanced**.
2. Select the desired value from the pull-down list of **HTTP**.
3. Enter the HTTP port number in the **HTTP Port (1~65535)** field.  
The default HTTP port number is 80.
4. Select the desired value from the pull-down list of **HTTPS**.

5. Enter the HTTPS port number in the **HTTPS Port (1~65535)** field.

The default HTTPS port number is 443.

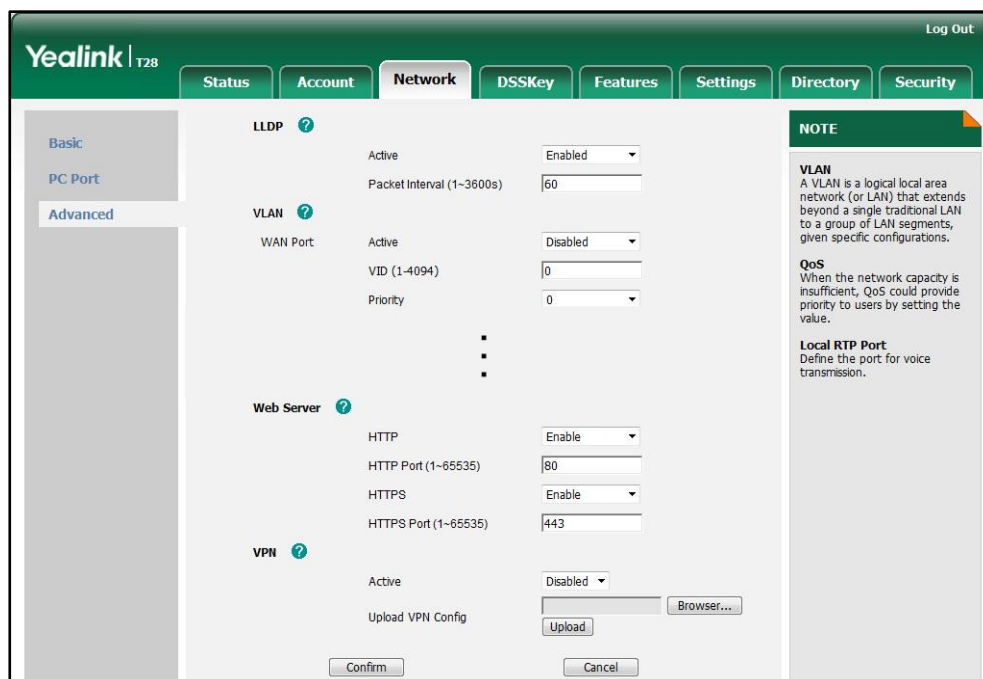

6. Click **Confirm** to accept the change.

A dialog box pops up to prompt that settings will take effect after reboot.

7. Click **OK** to reboot the IP phone.

**To configure web server type via phone user interface:**

1. Press **Menu->Settings->Advanced Settings** (password: admin) **->Network->Webserver Type**.
2. Press **◀** or **▶**, or the **Switch** soft key to select the desired value from the **Http Status** field.
3. Enter the HTTP port number in the **Http Port** field.
4. Press **◀** or **▶**, or the **Switch** soft key to select the desired value from the **Https Status** field.
5. Enter the HTTPS port number in the **Https Port** field.
6. Press the **Save** soft key to accept the change.

The IP phone reboots automatically to make settings effective after a period of time.

## Calling Line Identification Presentation

Calling line identification presentation (CLIP) allows IP phones to display the caller identity, derived from a SIP header contained in the INVITE message when receiving an incoming call. IP phones support deriving caller identity from three types of SIP header: From, P-Asserted-Identity and Remote-Party-ID. Identity presentation is based on the



identity in the relevant SIP header.

If the caller has existed in the local directory, the local name assigned to the caller should be preferentially displayed.

### Procedure

CLIP can be configured using the configuration files or locally.

<b>Configuration File</b>	<MAC>.cfg	Configure the presentation of the caller identity. For more information, refer to <a href="#">Calling Line Identification Presentation</a> on page 307.
<b>Local</b>	Web User Interface	Configure the presentation of the caller identity. <b>Navigate to:</b> http://<phoneIPAddress>/servlet?p=account-adv&q=load&acc=0

To configure the presentation of the caller identity via web user interface:

1. Click on **Account**.
2. Select the desired account from the pull-down list of **Account**.
3. Click on **Advanced**.
4. Select the desired value from the pull-down list of the **Caller ID Source**.

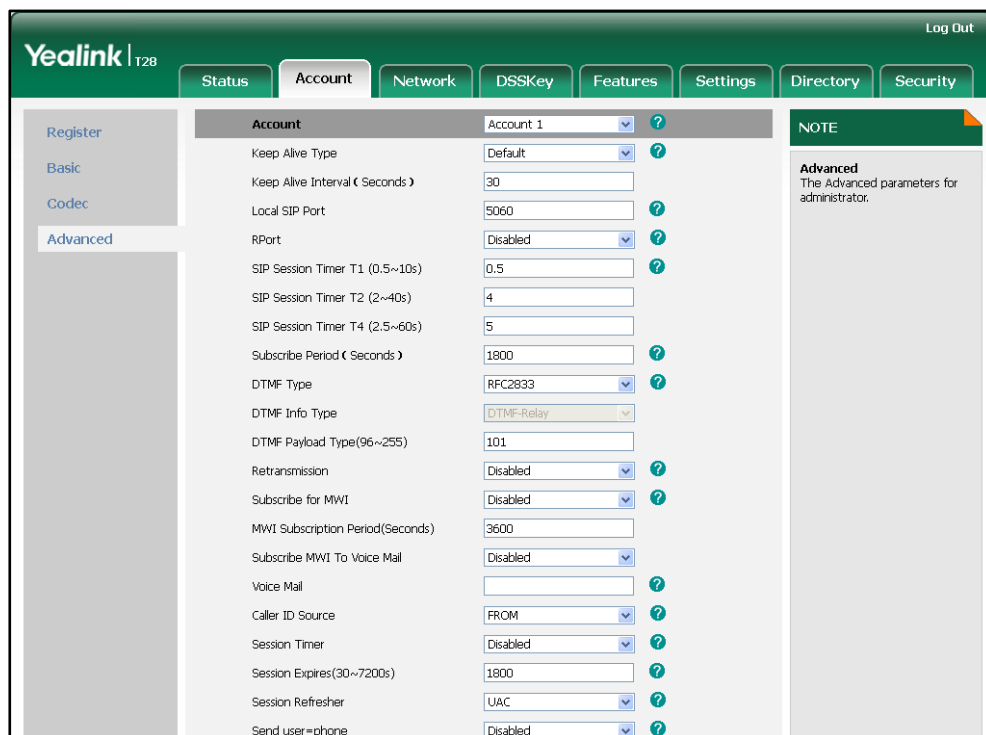

- Click **Confirm** to accept the change.

## Connected Line Identification Presentation

Connected line identification presentation (COLP) allows IP phones to display the identity of the callee specified for outgoing calls. IP phones can display the Dialed Digits, or the identity in a SIP header (Remote-Party-ID or P-Asserted-Identity) received, or the identity in the From header carried in the UPDATE message sent by the callee as described in RFC 4916.

If the callee has existed in the directory, the local name assigned to the callee should be preferentially displayed.

### Procedure

COLP can be configured only using the configuration files.

<b>Configuration File</b>	<MAC>.cfg	Configure the presentation of the callee's identity. For more information, refer to <a href="#">Connected Line Identification Presentation</a> on page 307.
---------------------------	-----------	--

## DTMF

DTMF (Dual Tone Multi-frequency), better known as touch-tone, is used for telecommunication signaling over analog telephone lines in the voice-frequency band. DTMF is the signal sent from the IP phone to the network, which is generated when pressing the IP phone's keypad during a call. Each key press on the IP phone generates one sinusoidal tone of two frequencies. One is generated from a high frequency group and the other from a low frequency group.

The DTMF keypad is laid out in a 4×4 matrix, with each row representing a low frequency, and each column representing a high frequency. Pressing a digit key (such as '1') will generate a sinusoidal tone for each of two frequencies (697 and 1209 hertz (Hz)).

### DTMF Keypad Frequencies:

	1209 Hz	1336 Hz	1447 Hz	1633 Hz
697 Hz	1	2	3	A
770 Hz	4	5	6	B
852 Hz	7	8	9	C
941 Hz	*	0	#	D

Three methods of transmitting DTMF digits on SIP calls:

- **RFC 2833** -- DTMF digits are transmitted by RTP Events compliant to RFC 2833.
- **INBAND** -- DTMF digits are transmitted in the voice band.
- **SIP INFO** -- DTMF digits are transmitted by SIP INFO messages.

The method of transmitting DTMF digits is configurable on a per-line basis.

### RFC 2833

DTMF digits are transmitted using the RTP Event packets that are sent along with the voice path. These packets use RFC 2833 format and must have a payload type that matches what the other end is listening for. The payload type for RTP Event packets is configurable. IP phones default to 101 for the payload type, which use the definition to negotiate with the other end during call establishment.

The RTP Event packet contains 4 bytes. The 4 bytes are distributed over several fields denoted as Event, End bit, R-bit, Volume and Duration. If the End bit is set to 1, the packet contains the end of the DTMF event. You can configure the number of times the IP phone sends the RTP Event packet with End bit set to 1.

### INBAND

DTMF digits are transmitted within the audio of the IP phone conversation. It uses the same codec as your voice and is audible to conversation partners.

### SIP INFO

DTMF digits are transmitted by the SIP INFO messages when the voice stream is established after a successful SIP 200 OK-ACK message sequence. The SIP INFO message is sent along the signaling path of the call. The SIP INFO message can support transmitting DTMF digits in three ways: DTMF, DTMF-Relay and Telephone-Event.

### Procedure

Configuration changes can be performed using the configuration files or locally.

<b>Configuration File</b>	<MAC>.cfg	Configure the method of transmitting DTMF digit and the payload type. For more information, refer to <a href="#">DTMF on page 308</a> .
	<y0000000000xx>.cfg	Configure the number of times for the IP phone to send the end RTP Event packet. For more information, refer to <a href="#">DTMF on page 308</a> .

<p><b>Local</b></p>	<p>Web User Interface</p>	<p>Configure the method of transmitting DTMF digits and the payload type.</p> <p><b>Navigate to:</b></p> <p>http://&lt;phoneIPAddress&gt;/servlet?&lt;p=account-adv&amp;q=load&amp;acc=0</p> <p>Configure the number of times for the IP phone to send the end RTP Event packet.</p> <p><b>Navigate to:</b></p> <p>http://&lt;phoneIPAddress&gt;/servlet?&lt;p=features-general&amp;q=load</p>
---------------------	---------------------------	--

**To configure the method of transmitting DTMF digits via web user interface:**

1. Click on **Account**.
2. Select the desired account from the pull-down list of **Account**.
3. Click on **Advanced**.
4. Select the desired value from the pull-down list of **DTMF Type**.
5. If **SIP INFO** or **AUTO** or **SIP INFO** is selected, select the desired value from the pull-down list of **DTMF Info Type**.
6. Enter the desired value in the **DTMF Payload Type (96~255)** field.

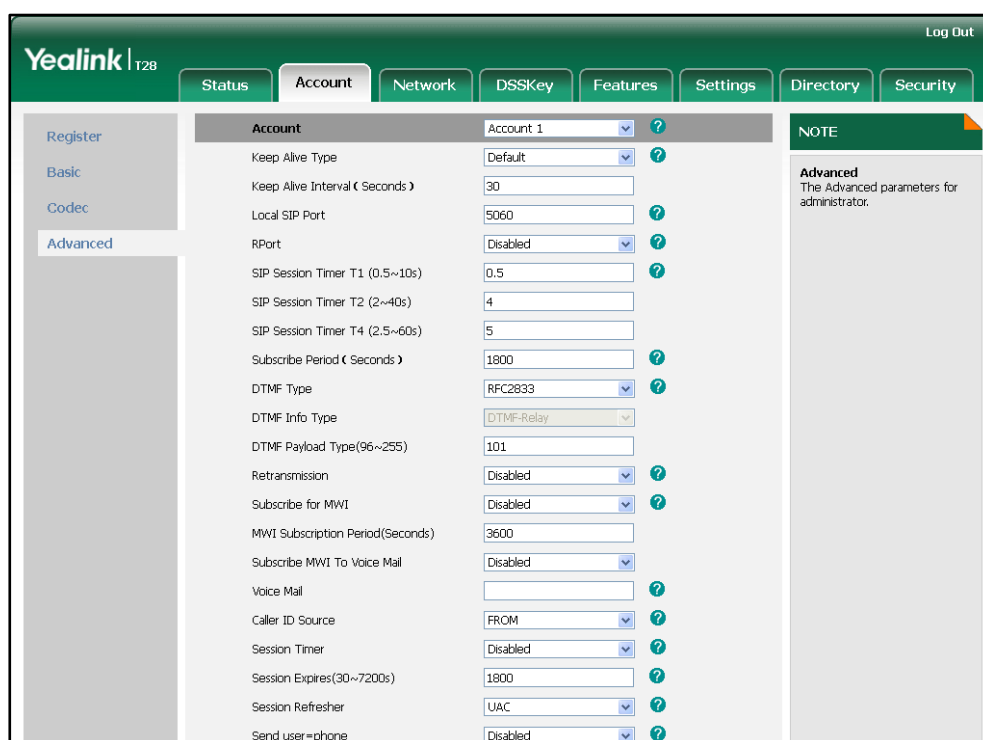

7. Click **Confirm** to accept the change.

To configure the number of times to send the end RTP Event packet via web user interface:

1. Click on **Features->General Information**.
2. Select the desired value (1-3) from the pull-down list of **DTMF Repetition**.

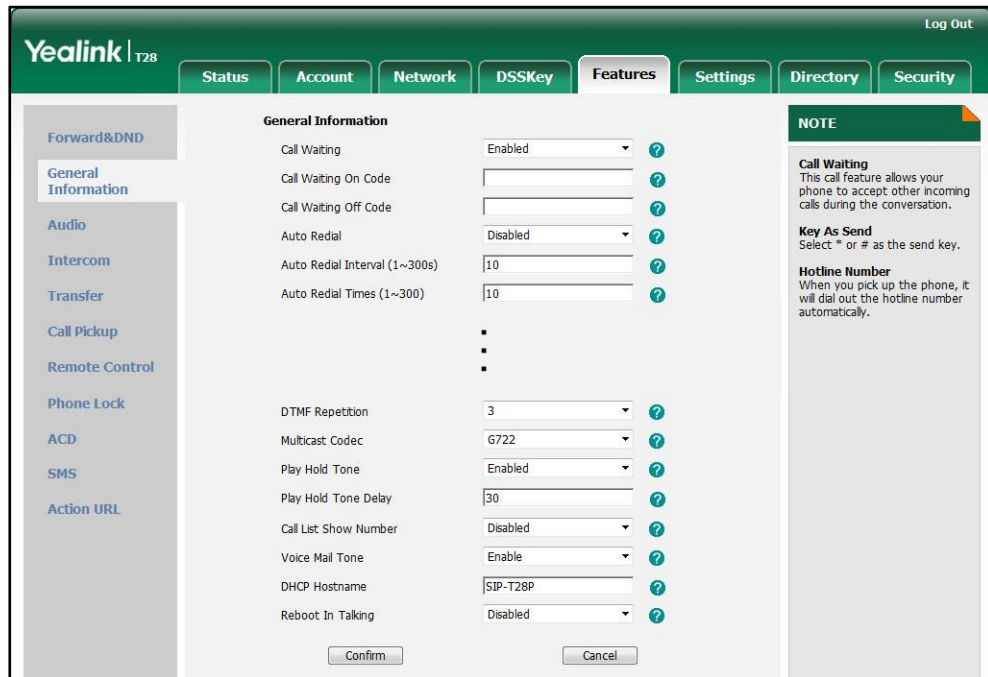

3. Click **Confirm** to accept the change.

## Suppress DTMF Display

Suppress DTMF display allows IP phones to suppress the display of DTMF digits. DTMF digits are displayed as “\*” on the LCD screen. Suppress DTMF display delay defines whether to display the DTMF digits for a short period of time before displaying as “\*”.

### Procedure

Configuration changes can be performed using the configuration files or locally.

<b>Configuration File</b>	<y0000000000xx>.cfg	Configure suppress DTMF display and suppress DTMF display delay. For more information, refer to <a href="#">Suppress DTMF Display</a> on page 310.
<b>Local</b>	Web User Interface	Configure suppress DTMF display and suppress DTMF

		display delay. <b>Navigate to:</b> http://<phoneIPAddress>/servlet?<phoneIPAddress>/servlet?p=features-general&q=load
--	--	---

To configure suppress DTMF display and suppress DTMF display delay via web user interface:

1. Click on **Features->General Information**.
2. Select the desired value from the pull-down list of **Suppress DTMF Display**.
3. Select the desired value from the pull-down list of **Suppress DTMF Display Delay**.

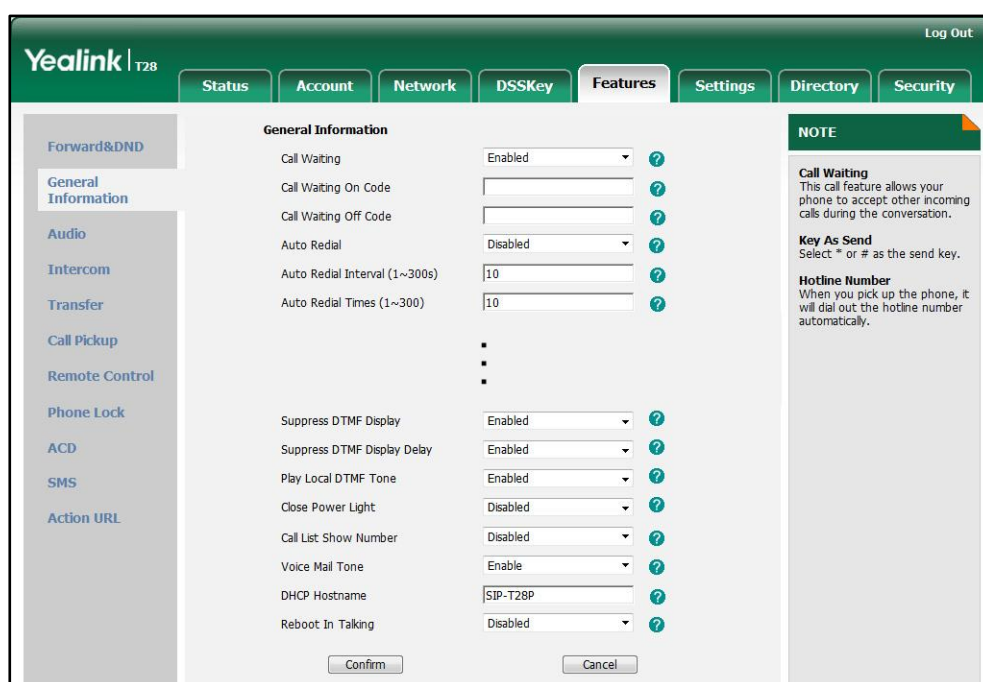

4. Click **Confirm** to accept the change.

## Transfer via DTMF

Call transfer is implemented via DTMF on some traditional servers. The IP phone sends specified DTMF digits to the server for transferring calls to a third party.

### Procedure

Configuration changes can be performed using the configuration files or locally.

<b>Configuration File</b>	<y0000000000xx>.cfg	Configure transfer via DTMF. For more information, refer to <a href="#">Transfer via DTMF</a> on page 311.
---------------------------	---------------------	---

<p><b>Local</b></p>	<p>Web User Interface</p>	<p>Configure transfer via DTMF.  <b>Navigate to:</b>  <a href="http://&lt;phoneIPAddress&gt;/servlet?p=features-general&amp;q=load">http://&lt;phoneIPAddress&gt;/servlet?p=features-general&amp;q=load</a></p>
---------------------	---------------------------	---

To configure transfer via DTMF via web user interface:

1. Click on **Features->General Information**.
2. Select the desired value from the pull-down list of **DTMF Replace Tran**.
3. Enter the specified DTMF digits in the **Tran Send DTMF** field.

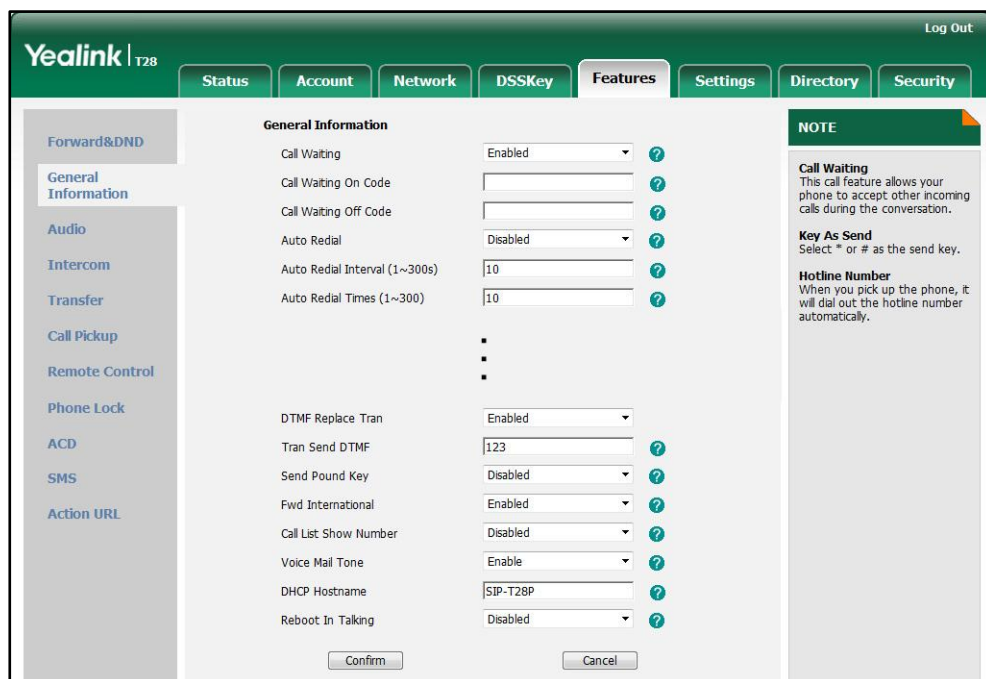

4. Click **Confirm** to accept the change.

## Intercom

Intercom allows establishing an audio conversation directly. The IP phone can answer intercom calls automatically. This feature depends on support from a SIP server.

## Outgoing Intercom Calls

Intercom is a useful feature in office environments to quickly connect with an operator or secretary. Users can press an intercom key to automatically initiate an outgoing intercom call with a remote extension. This feature is not applicable to the SIP-T19P IP phone.

## Procedure

Intercom key can be configured using the configuration files or locally.

<b>Configuration File</b>	<y0000000000xx>.cfg	Assign an intercom key. For more information, refer to <a href="#">Intercom Key</a> on page 390.
<b>Local</b>	Web User Interface	Assign an intercom key. <b>Navigate to:</b> http://<phoneIPAddress>/servlet? ?p=dsskey&q=load&model=0
	Phone User Interface	Assign an intercom key.

**To configure an intercom key via web user interface:**

1. Click on **DSSKey->Memory Key** (or **Line Key**).
2. In the desired memory key (or line key) field, select **Intercom** from the pull-down list of **Type**.
3. Enter the remote extension number in the **Value** field.
4. Select the desired line from the pull-down list of **Line**.

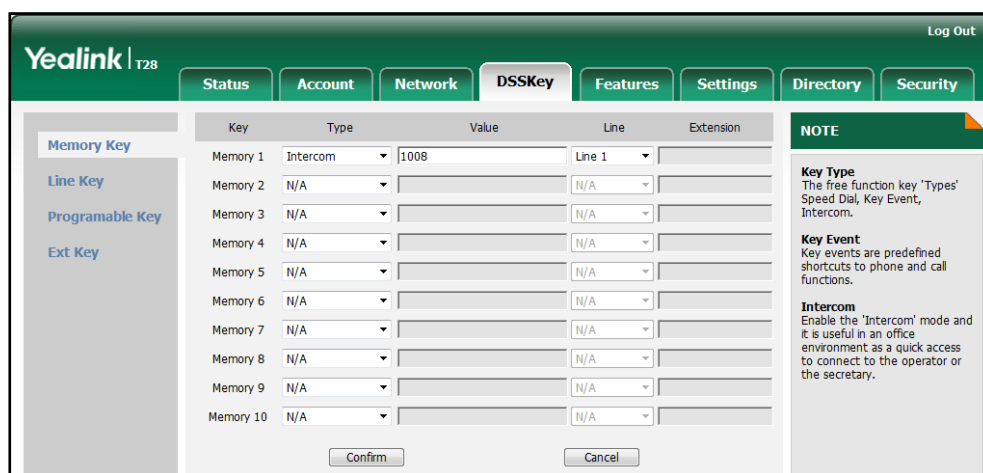

5. Click **Confirm** to accept the change.

**To configure an intercom key via phone user interface:**

1. Press **Menu->Features->DSS Keys->Memory Keys** (or **Line Keys**).
2. Select the desired DSS key.
3. Press **◀** or **▶**, or the **Switch** soft key to select **Intercom** from the **Type** field.
4. Select the desired line from the **Account ID** field.
5. Enter the remote extension number in the **Value** field.
6. Press the **Save** soft key to accept the change.



## Incoming Intercom Calls

The IP phone can process incoming calls differently depending on settings. Four configuration options for incoming intercom calls:

### Accept Intercom

Accept Intercom allows the IP phone to automatically answer an incoming intercom call.

### Intercom Mute

Intercom Mute allows the IP phone to mute the microphone for incoming intercom calls.

### Intercom Tone

Intercom Tone allows the IP phone to play a warning tone before answering an intercom call.

### Intercom Barge

Intercom Barge allows the IP phone to automatically answer an incoming intercom call while an active call is in progress. The active call will be placed on hold.

## Procedure

Incoming intercom calls can be configured using the configuration files or locally.

<b>Configuration File</b>	<y0000000000xx>.cfg	Configure incoming intercom call feature. For more information, refer to <a href="#">Incoming Intercom calls</a> on page 311.
<b>Local</b>	Web User Interface	Configure incoming intercom call feature. <b>Navigate to:</b> http://<phoneIPAddress>/servlet?p=features-intercom&q=load
	Phone User Interface	Configure incoming intercom call feature.

**To configure intercom via web user interface:**

1. Click on **Features->Intercom**.

2. Select the desired values from the pull-down lists of **Accept Intercom**, **Intercom Mute**, **Intercom Tone** and **Intercom Barge**.

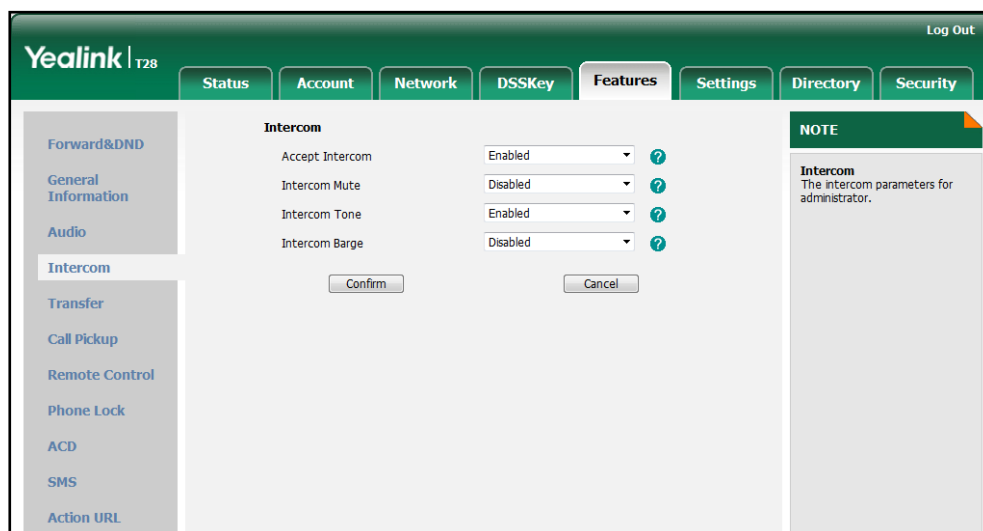

3. Click **Confirm** to accept the change.

To configure intercom via phone user interface:

1. Press **Menu->Features->Intercom**.
2. Press **◀** or **▶** , or the **Switch** soft key to select the desired values from the **Accept Intercom**, **Intercom Mute**, **Warning Tone** and **Intercom Barge** fields.
3. Press the **Save** soft key to accept the change.

---

# Configuring Advanced Features

---

This chapter provides information for making configuration changes for the following advanced features:

- [Distinctive Ring Tones](#)
- [Tones](#)
- [Remote Phone Book](#)
- [LDAP](#)
- [Busy Lamp Field](#)
- [Music on Hold](#)
- [Automatic Call Distribution](#)
- [Message Waiting Indicator](#)
- [Multicast Paging](#)
- [Call Recording](#)
- [Hot Desking](#)
- [Action URL](#)
- [Action URI](#)
- [Server Redundancy](#)
- [LLDP](#)
- [VLAN](#)
- [VPN](#)
- [Quality of Service](#)
- [Network Address Translation](#)
- [SNMP](#)
- [802.1X Authentication](#)
- [TR-069 Device Management](#)
- [IPv6 Support](#)

## Distinctive Ring Tones

Distinctive ring tones allows certain incoming calls to trigger IP phones to play distinctive ring tones. The IP phone inspects the INVITE request for an "Alert-Info" header when receiving an incoming call. If the INVITE request contains an "Alert-Info" header, the IP phone strips out the URL and keyword parameter and maps them to the appropriate

ring tone.

Alert-Info headers in the following two formats:

Alert-Info: http://localIP/Bellcore-drN

Alert-Info: <URL>;info=info text;x-line-id=0

- If the Alter-Info header contains the keyword “Bellcore-drN”, the IP phone will play the Bellcore-drN ring tone (N=1, 2, 3, 4 or 5).

Example:

Alert-Info: http://127.0.0.1/Bellcore-dr1

The following table identifies the different Bellcore ring tone patterns and cadences.

Bellcore Tone	Pattern ID	Pattern	Cadence	Minimum Duration (ms)	Nominal Duration (ms)	Maximum Duration (ms)
Bellcore-dr1 (standard)	1	Ringing	2s On	1800	2000	2200
		Silent	4s Off	3600	4000	4400
Bellcore-dr2	2	Ringing	Long	630	800	1025
		Silent		315	400	525
		Ringing	Long	630	800	1025
		Silent		3475	4000	4400
Bellcore-dr3	3	Ringing	Short	315	400	525
		Silent		145	200	525
		Ringing	Short	315	400	525
		Silent		145	200	525
		Ringing	Long	630	800	1025
		Silent		2975	4000	4400
Bellcore-dr4	4	Ringing	Short	200	300	525
		Silent		145	200	525
		Ringing	Long	800	1000	1100
		Silent		145	200	525
		Ringing	Short	200	300	525
		Silent		2975	4000	4400
Bellcore-dr5	5	Ringing		450	500	550

**Note**

“Bellcore-dr5” is a ring splash tone that reminds the user that the DND or Always Call Forward feature is enabled on the server side.

- If the Alert-Info header contains a remote URL, the IP phone will try to download the WAV ring tone file from the URL and then play the remote ring tone. If it fails to download the file, the IP phone will play the local ring tone associated with **info text**. If there is no text matched, the IP phone will play the preconfigured local ring tone in about ten seconds.

Example:

Alert-Info: http://192.168.0.12:8080/ring.wav/info=family;x-line-id=0

### Procedure

Distinctive ring tones can be configured using the configuration files or locally.

<b>Configuration File</b>	<MAC>.cfg	Configure distinctive ring tones. For more information, refer to <a href="#">Distinctive Ring Tones</a> on page 313.
	<y0000000000xx>.cfg	Configure the internal ringer text and internal ringer file. For more information, refer to <a href="#">Distinctive Ring Tones</a> on page 313.
<b>Local</b>	Web User Interface	Configure distinctive ring tones. <b>Navigate to:</b> http://<phoneIPAddress>/servlet?p=account-adv&q=load&acc=0  Configure the internal ringer text and internal ringer file. <b>Navigate to:</b> http://<phoneIPAddress>/servlet?p=settings-ring&q=load

**To configure distinctive ring tones via web user interface:**

1. Click on **Account**.
2. Select the desired account from the pull-down list of **Account**.
3. Click on **Advanced**.

- Select the desired value from the pull-down list of **Distinctive Ring Tones**.

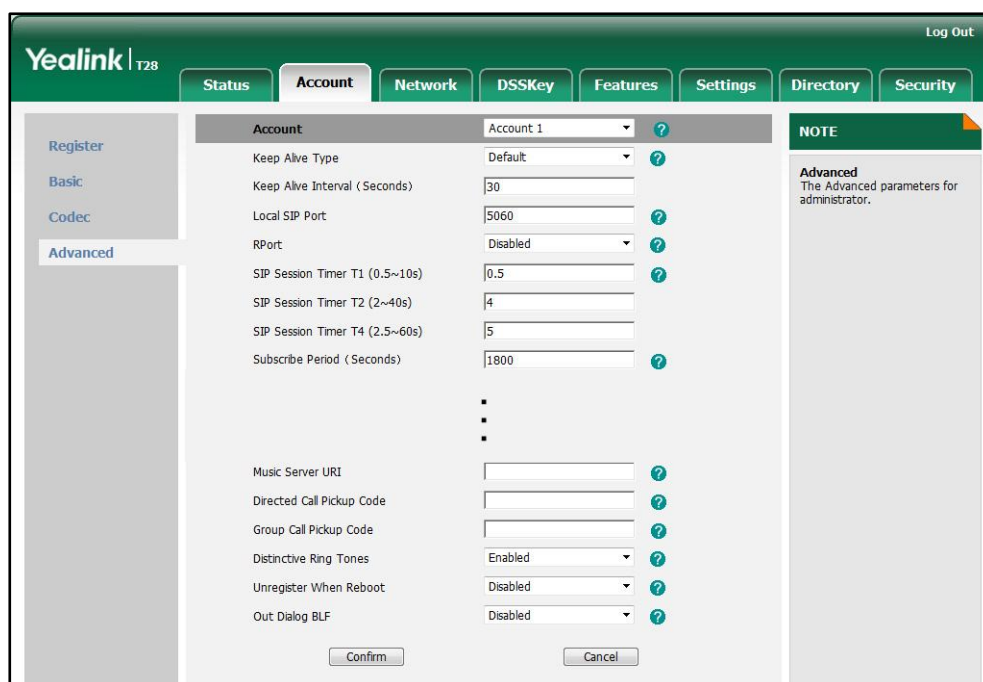

- Click **Confirm** to accept the change.

To configure the internal ringer text and internal ringer file via web user interface:

- Click on **Settings->Ring**.
- Enter the keywords in the **Internal Ringer Text** fields.
- Select the desired ring tones for each text from the pull-down lists of **Internal Ringer File**.

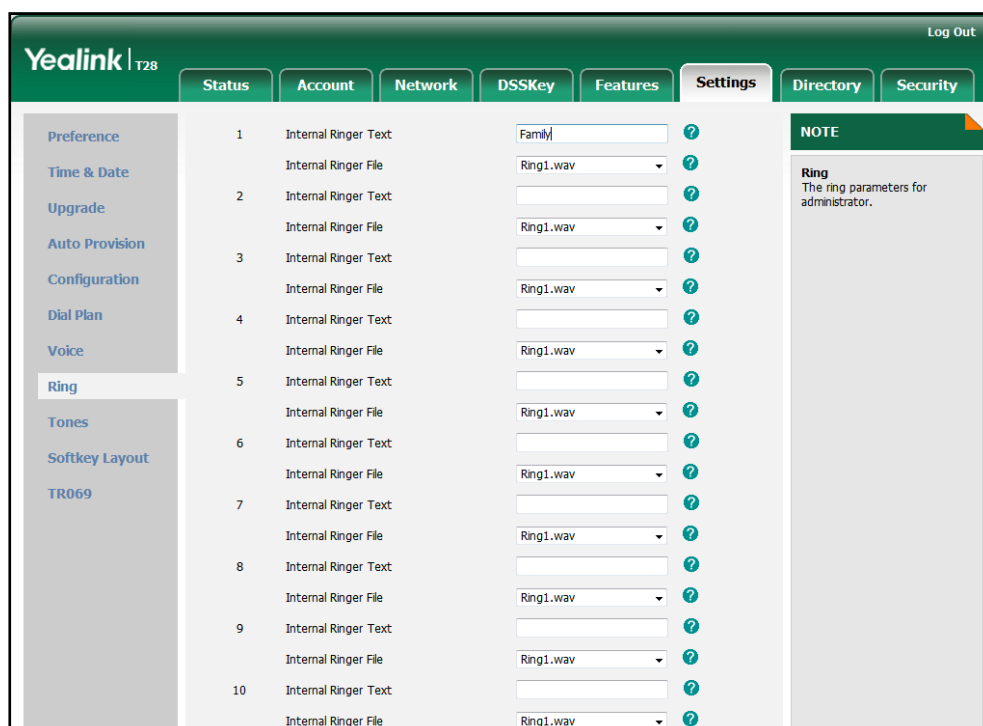

4. Click **Confirm** to accept the change.

## Tones

When receiving a message, the IP phone will play a warning tone. You can customize tones or select specialized tone sets (vary from country to country) to indicate different conditions of the IP phone. The default tones used on IP phones are the US tone sets.

Available tone sets for IP phones:

- Australia
- Austria
- Brazil
- Belgium
- China
- Czech
- Denmark
- Finland
- France
- Germany
- Great Britain
- Greece
- Hungary
- Lithuania
- India
- Italy
- Japan
- Mexico
- New Zealand
- Netherlands
- Norway
- Portugal
- Spain
- Switzerland
- Sweden
- Russia
- United States

- Chile
- Czech ETSI

Configured tones can be heard on IP phones for the following conditions.

Condition	Description
Dial	When in the pre-dialing interface
Ring Back	Ring-back tone
Busy	When the callee is busy
Congestion	When the network is congested
Call Waiting	Call waiting tone
Dial Recall	When receiving a call back
Info	When receiving a special message
Stutter	When receiving a voice mail
Message	When receiving a text message
Auto Answer	When automatically answering a call

## Procedure

Tones can be configured using the configuration files or locally.

<b>Configuration File</b>	<y0000000000xx>.cfg	Configure the tones for the IP phone. For more information, refer to <a href="#">Tones</a> on page 315.
<b>Local</b>	Web User Interface	Configure the tones for the IP phone. <b>Navigate to:</b> http://<phoneIPAddress>/servlet?p=settings-tones&q=load

### To configure tones via web user interface:

1. Click on **Settings->Tones**.
2. Select the desired type from the pull-down list of **Select Country**.



If you select **Custom**, you can customize a tone for each condition of the IP phone.

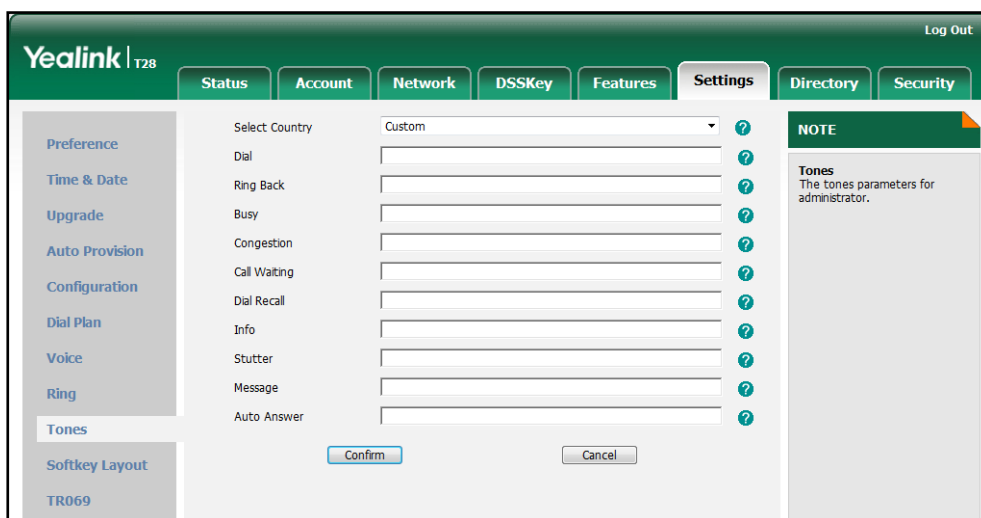

3. Click **Confirm** to accept the change.

## Remote Phone Book

Remote phone book is centrally maintained phone book, stored on the remote server. Users only need the access URL of the remote phone book. The IP phone can establish a connection with the remote server and download the phone book, and then display the phone book entries on the phone user interface. IP phones support up to 5 remote phone books. Remote phone book is customizable. For more information, refer to [Remote XML Phone Book](#) on page 226.

Sremote Name allows IP phones to query the entry names from the remote phone book when receiving incoming calls. Sremote Name Flash Time defines how often IP phones refresh the local cache of the remote phone book.

**Note** Remote phone book is not applicable to the SIP-T20P IP phone.

### Procedure

Remote phone book can be configured using the configuration files or locally.

<p><b>Configuration File</b></p>	<p>&lt;y0000000000xx&gt;.cfg</p>	<p>Specify the access URL of the remote phone book.</p> <p>Specify whether to query the entry name from the remote phone book when the IP phone receives an incoming call.</p> <p>Specify how often the IP phone refreshes the local cache of the</p>
----------------------------------	----------------------------------	---

		<p>remote phone book.</p> <p>For more information, refer to <a href="#">Remote Phone Book</a> on page 317.</p>
<b>Local</b>	Web User Interface	<p>Specify the access URL of the remote phone book.</p> <p><b>Navigate to:</b>  <code>http://&lt;phoneIPAddress&gt;/servlet?p=contacts-remote&amp;q=load</code></p> <p>Specify whether to query the entry name from the remote phone book when the IP phone receives an incoming call.</p> <p>Specify how often the IP phone refreshes the local cache of the remote phone book.</p> <p><b>Navigate to:</b>  <code>http://&lt;phoneIPAddress&gt;/servlet?p=contacts-remote&amp;q=load</code></p>

**To specify access URL of the remote phone book via web user interface:**

1. Click on **Directory->Remote Phone Book**.
2. Enter the access URL in the **Remote URL** field.
3. Enter the name in the **Display Name** field.

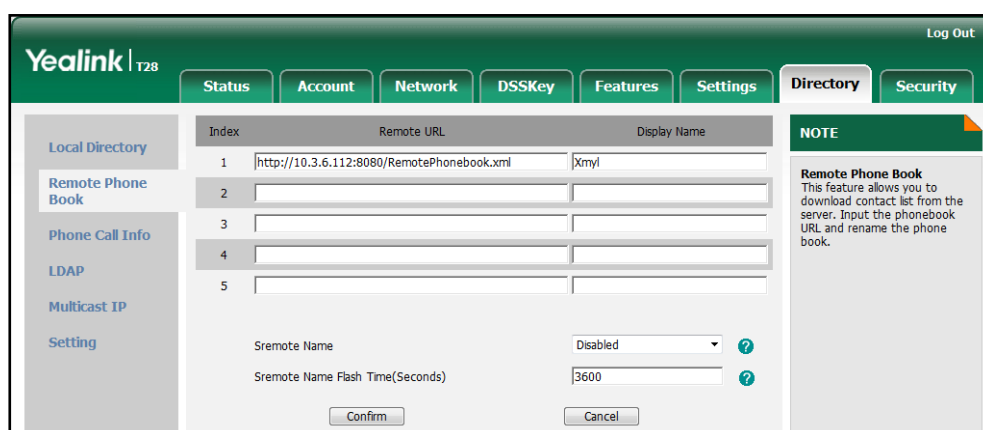

4. Click **Confirm** to accept the change

**To configure Sremote Name and Sremote Name Flash Time via web user interface:**

1. Click on **Directory->Remote Phone Book**.
2. Select the desired value from the pull-down list of **Sremote Name**.

- Enter the desired time in the **Sremote Name Flash Time (Seconds)** field.

Index	Remote URL	Display Name
1	http://10.3.6.112:8080/RemotePhonebook.xml	Xmyl
2		
3		
4		
5		

Sremote Name: Enabled

Sremote Name Flash Time(Seconds): 3600

NOTE: Remote Phone Book. This feature allows you to download contact list from the server. Input the phonebook URL and rename the phone book.

- Click **Confirm** to accept the change.

## LDAP

LDAP (Lightweight Directory Access Protocol) is an application protocol for accessing and maintaining information services for the distributed directory over an IP network. IP phones can be configured to interface with a corporate directory server that supports LDAP version 2 or 3 (Microsoft's Active Directory is included).

The biggest plus for LDAP is that users can access the central LDAP directory of the corporation using IP phones, so they do not have to maintain the directory locally. Users can search and dial from the LDAP directory, and save LDAP entries to the local directory. LDAP entries displayed on the IP phone are read only. Users can not add, edit or delete the LDAP entries. When an LDAP server is properly configured, the IP phone can look up entries from the LDAP server in a wide variety of ways. The LDAP server indexes all the data in its entries, and "filters" may be used to select the desired entry or group, and return the desired information.

Configurations on the IP phone limit the amount of the displayed entries when querying from the LDAP server, and decide how attributes are displayed and sorted.

**Note** LDAP is not applicable to SIP-T19P and SIP-T20P IP phones.

You can set a DSS key to be an LDAP key, and then press the LDAP key to enter the LDAP search screen when the IP phone is idle.

## LDAP Attributes

The following table lists the most common attributes used to configure the LDAP lookup on IP phones.

Abbreviation	Name	Description
gn	givenName	First name
cn	commonName	LDAP attribute being made up from given name joined to surname.
sn	surname	Last name or family name
dn	distinguishedName	Unique identifier for each entry
dc	dc	Domain component
-	company	Company or organization name
-	telephoneNumber	Office phone number
mobile	mobilephoneNumber	Mobile or cellular phone number
ipPhone	IPphoneNumber	Home phone number

## Procedure

LDAP can be configured using the configuration files or locally.

<b>Configuration File</b>	<y0000000000xx>.cfg	<p>Configure LDAP.</p> <p>For more information, refer to <a href="#">LDAP</a> on page 318.</p> <p>Assign an LDAP key.</p> <p>For more information, refer to <a href="#">LDAP Key</a> on page 391.</p>
<b>Local</b>	Web User Interface	<p>Configure LDAP.</p> <p><b>Navigate to:</b></p> <p>http://&lt;phoneIPAddress&gt;/servlet?p=contacts-LDAP&amp;q=load</p> <p>Assign an LDAP key.</p> <p><b>Navigate to:</b></p> <p>http://&lt;phoneIPAddress&gt;/servlet?p=dsskey&amp;q=load&amp;model=0</p>
	Phone User Interface	Assign an LDAP key.

**To configure LDAP via web user interface:**

1. Click on **Directory->LDAP**.

2. Enter the values in the corresponding fields.
3. Select the desired values from the corresponding pull-down list.

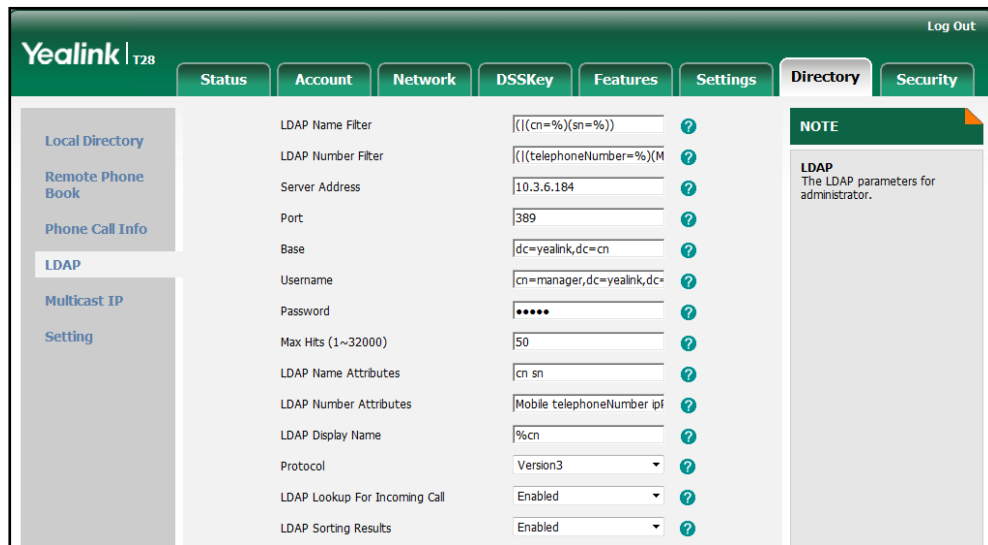

4. Click **Confirm** to accept the change.

**To configure an LDAP key via web user interface:**

1. Click on **DSSKey->Memory Key (Line Key or Programable Key)**.
2. In the desired DSS key field, select **LDAP** from the pull-down list of **Type**.

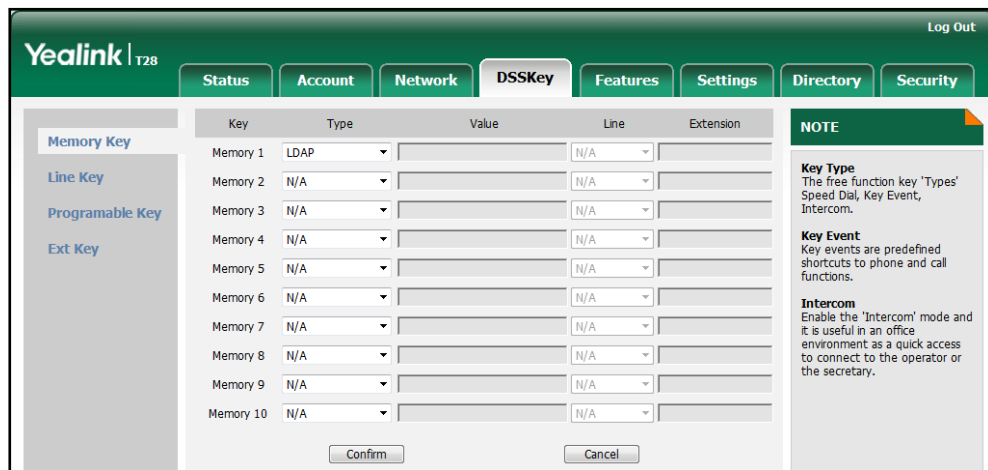

3. Click **Confirm** to accept the change.

**To configure an LDAP key via phone user interface:**

1. Press **Menu->Features->DSS Keys->Memory Keys (or Line Keys)**.
2. Select the desired DSS key.
3. Press **◀** or **▶**, or the **Switch** soft key to select **Key Event** from the **Type** field.
4. Press **◀** or **▶**, or the **Switch** soft key to select **LDAP** from the **Key Type** field.
5. Press the **Save** soft key to accept the change.

## Busy Lamp Field

Busy Lamp Field (BLF) is used to monitor a specific user for status changes on IP phones. For example, you can configure a BLF key on a supervisor's phone to monitor the phone user status (busy or idle). When the monitored user makes a call, a busy indicator on the supervisor's phone shows that the user's phone is in use. This feature is not applicable to the SIP-T19P IP phone.

When the monitored user is idle, the supervisor presses the BLF key to dial out the phone number. When the monitored user receives an incoming call, the supervisor presses the BLF key to pick up the call directly. When the monitored user is on a call, the supervisor presses the BLF key to interrupt and set up a conference call.

### Visual Alert and Audio Alert for BLF Pickup

Visual and audio alert for BLF pickup allow the supervisor's phone to play an alert tone and display a visual prompt (e.g., "6001 <-6002", 6001 is the monitored extension and receives an incoming call from 6002) when the monitored user receives an incoming call. In addition to the BLF key, visual alert for BLF pickup feature enables the supervisors to pick up the monitored user's incoming call by pressing the Pickup soft key. The directed call pickup code must be configured in advance. For more information on how to configure the directed call pickup code for the Pickup soft key, refer to [Directed Call Pickup](#) on page 104.

#### Note

Visual alert for BLF pickup feature is not applicable to SIP-T19P and SIP-T20P IP phones. Audio alert for BLF pickup feature is not applicable to the SIP-T19P IP phone.

### LED Off in Idle

LED off in idle defines two flashing methods for the BLF key LED. The BLF key LED flashes as below:

**Line key LED** (configured as BLF key when LED Off in Idle is disabled)

LED Status	Description
Solid green	The monitored user is idle.
Fast flashing green	The monitored user receives an incoming call.
Slow flashing green (500ms)	The monitored user is busy.
Slow flashing green (1s)	The call is parked against the monitored user's phone number.
Off	The monitored user does not exist.

**Memory key LED** (configured as BLF key when LED Off in Idle is disabled)

LED Status	Description
Solid green	The monitored user is idle.
Fast flashing red	The monitored user receives an incoming call.
Solid red	The monitored user is busy.
Slow flashing red (1s)	The call is parked against the monitored user's phone number.
Off	The monitored user does not exist.

**Line key LED** (configured as BLF key when LED Off in Idle is enabled)

LED Status	Description
Fast flashing green	The monitored user receives an incoming call.
Slow flashing green (500ms)	The monitored user is busy.
Slow flashing red (1s)	The call is parked against the monitored user's phone number.
Off	The monitored user is idle. The monitored user does not exist.

**Memory key LED** (configured as BLF key when LED Off in Idle is enabled)

LED Status	Description
Fast flashing red	The monitored user receives an incoming call.
Solid red	The monitored user is busy.
Slow flashing red (1s)	The call is parked against the monitored user's phone number.
Off	The monitored user is idle. The monitored user does not exist.

**Procedure**

BLF can be configured using the configuration files or locally.

<b>Configuration File</b>	y000000000xx.cfg	<p>Assign a BLF key.</p> <p>For more information, refer to <a href="#">BLF Key</a> on page 392.</p> <p>Specify whether to use visual alert and audio alert for BLF pickup.</p> <p>Configure LED off in idle.</p> <p>For more information, refer to</p>
---------------------------	------------------	--

		BLF on page 323.
Local	Web User Interface	<p>Assign a BLF key.</p> <p><b>Navigate to:</b></p> <p>http://&lt;phoneIPAddress&gt;/servlet?p=dsskey&amp;q=load&amp;model=0</p> <p>Specify whether to use visual alert and audio alert for BLF pickup.</p> <p><b>Navigate to:</b></p> <p>http://&lt;phoneIPAddress&gt;/servlet?p=features-callpickup&amp;q=load</p> <p>Configure LED off in idle.</p> <p><b>Navigate to:</b></p> <p>http://&lt;phoneIPAddress&gt;/servlet?p=features-general&amp;q=load</p>
	Phone User Interface	Assign a BLF key.

**To configure a BLF key via web user interface:**

1. Click on **DSSKey->Memory Key** (or **Line Key**).
2. In the desired memory key (or line key) field, select **BLF** from the pull-down list of **Type**.
3. Enter the phone number or extension you want to monitor in the **Value** field.
4. Select the desired line from the pull-down list of **Line**.
5. (Optional.) Enter the directed call pickup code in the **Extension** field.

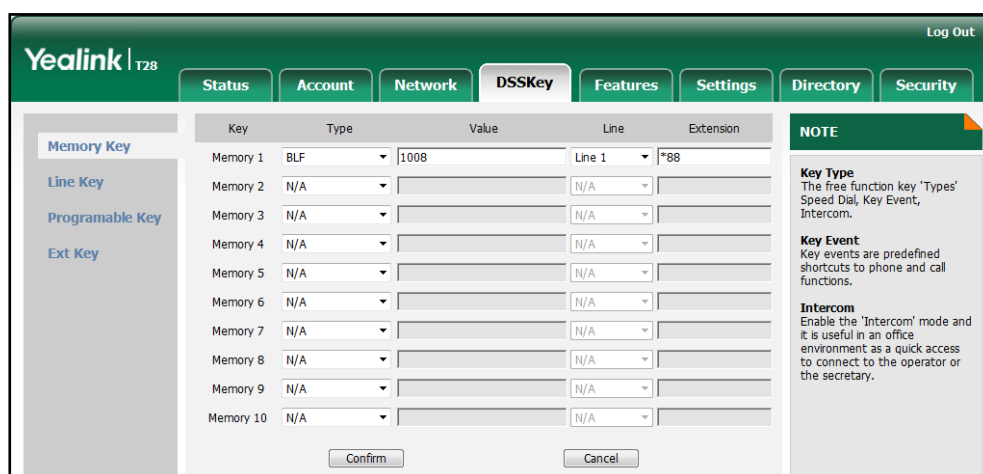

6. Click **Confirm** to accept the change.



To configure visual alert and audio alert for BLF pickup via web user interface:

1. Click on **Features->Call Pickup**.
2. Select the desired value from the pull-down list of **Visual Alert for BLF Pickup**.
3. Select the desired value from the pull-down list of **Audio Alert for BLF Pickup**.

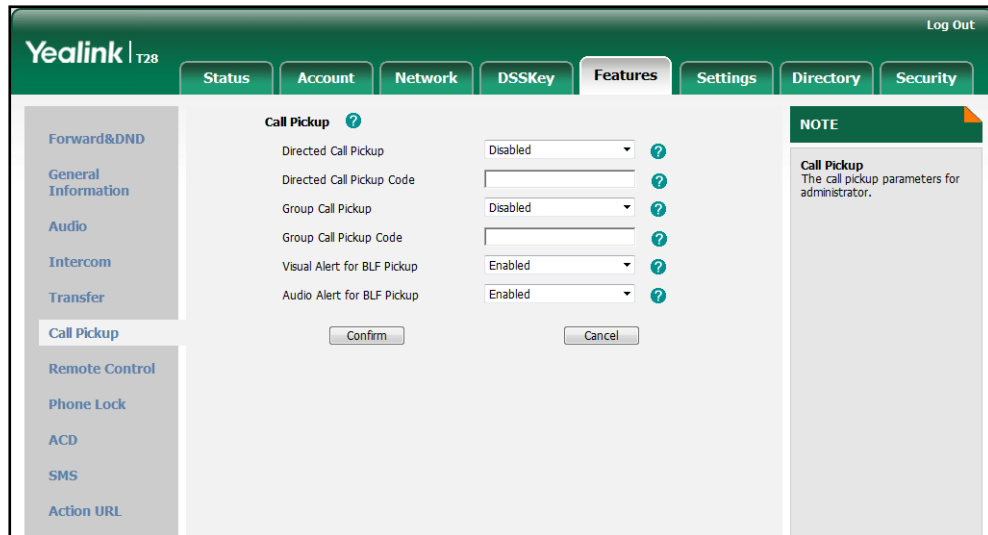

4. Click **Confirm** to accept the change.



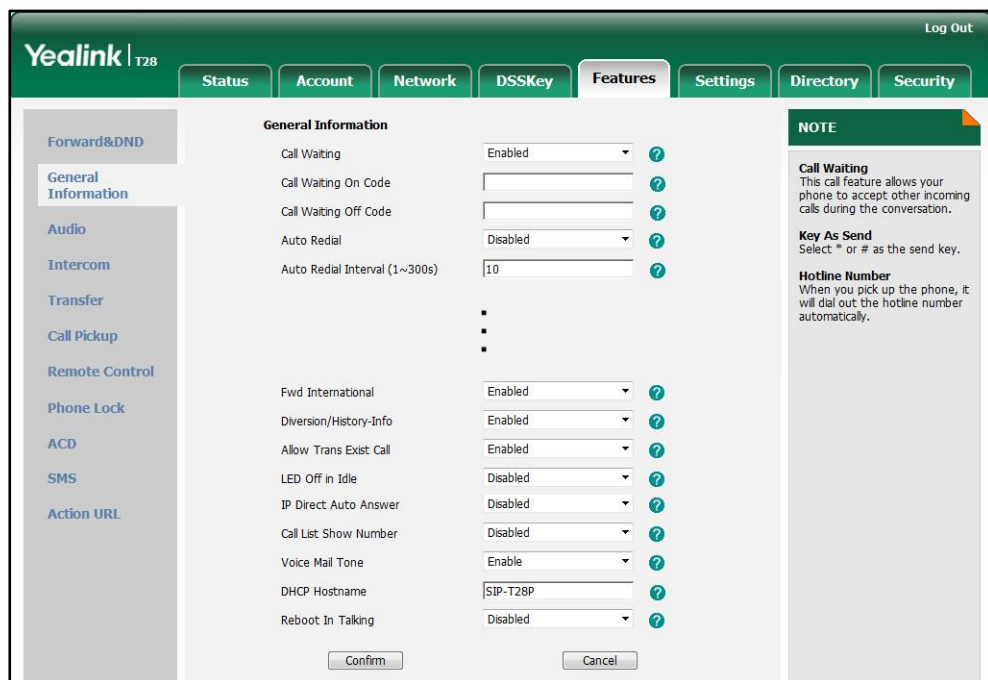

To configure LED off in idle via web user interface:

1. Click on **Features->General Information**.
2. Select the desired value from the pull-down list of **LED Off in Idle**.



3. Click **Confirm** to accept the change.

**To configure a BLF key via phone user interface:**

1. Press **Menu->Features->DSS Keys->Memory Keys** (or **Line Keys**).
2. Select the desired DSS key.
3. Press  or  , or the **Switch** soft key to select **BLF** from the **Type** field.
4. Press  or  , or the **Switch** soft key to select the desired line from the **Account ID** field.
5. Enter the phone number or extension you want to monitor in the **Value** field.
6. (Optional.) Enter the directed call pickup code in the **Extension** field.
7. Press the **Save** soft key to accept the change.

## Music on Hold

Music on Hold (MoH) is the business practice of playing recorded music to fill the silence that would be heard by the party who has been placed on hold. To use this feature, specify a SIP URI pointing to a MoH server account. When a call is placed on hold, the IP phone will send an INVITE message to the specified MoH server account according to the SIP URI. The MoH server account automatically responds to the INVITE message and immediately plays audio from some source located anywhere (LAN, Internet) to the held party.

### Procedure

Music on hold can be configured using the configuration files or locally.

<b>Configuration File</b>	<MAC>.cfg	Configure MoH on a per-line basis. For more information, refer to <a href="#">Music on Hold</a> on page 325.
<b>Local</b>	Web User Interface	Configure MoH on a per-line basis. <b>Navigate to:</b> http://<phoneIPAddress>/servlet ?p=account-adv&q=load&acc=0

**To configure MoH via web user interface:**

1. Click on **Account**.
2. Select the desired account from the pull-down list of **Account**.
3. Click on **Advanced**.

- Enter the SIP URI (e.g., sip:moh@sip.com) in the **Music Server URI** field.

The screenshot shows the Yealink T28 web interface with the 'Account' tab selected. The 'Advanced' sub-tab is active. The 'Music Server URI' field is populated with 'sip:moh@sip.com'. Other configuration options include 'Keep Alive Type' (Default), 'Keep Alive Interval (Seconds)' (30), 'Local SIP Port' (5060), 'RPort' (Disabled), 'SIP Session Timer T1 (0.5~10s)' (0.5), 'SIP Session Timer T2 (2~40s)' (4), 'SIP Session Timer T4 (2.5~60s)' (5), and 'Subscribe Period (Seconds)' (1800). A 'NOTE' box on the right indicates that advanced parameters are for administrators. The 'Confirm' button is visible at the bottom.

- Click **Confirm** to accept the change.

## Automatic Call Distribution

Automatic Call Distribution (ACD) enables organizations to manage a large number of phone calls on an individual basis. ACD enables the use of IP phones in a call-center role by automatically distributing incoming calls to available users, or agents. ACD depends on support from a SIP server. ACD is disabled on the phone by default. You need to enable it on a per-line basis before logging into the ACD system.

After the IP phone user logs into the ACD system, the server monitors the phone status and then decides whether to assign an incoming call to the user's IP phone. When the phone status is changed to unavailable, the server stops distributing calls to the IP phone. The IP phone will remain in the unavailable status until the user manually changes the phone status or the ACD auto available timer (if configured) expires. How long the IP phone remains unavailable is configurable by auto-available timer. When the timer expires, the phone status is automatically changed to available. ACD auto available feature depends on support from a SIP server.

You need to configure an ACD key for the user to log into the ACD system. The ACD key LED on the IP phone indicates the ACD status.

### Note

The SIP-T19P IP phone supports ACD feature for BroadSoft server only. For more information, refer to *Yealink IP Phones Deployment Guide for BroadWorks Environments*.

## Procedure

ACD can be configured using the configuration files or locally.

<b>Configuration File</b>	<y0000000000xx>.cfg	Assign an ACD key. For more information, refer to <a href="#">ACD Key</a> on page 393. Configure ACD auto available. For more information, refer to <a href="#">ACD</a> on page 325.
<b>Local</b>	Web User Interface	Assign an ACD key. <b>Navigate to:</b> http://<phoneIPAddress>/servlet ?p=dsskey&q=load&model=0 Configure ACD auto available. <b>Navigate to:</b> http://<phoneIPAddress>/servlet ?p=features-acd&q=load
	Phone User Interface	Assign an ACD key.

To configure an ACD key via web user interface:

1. Click on **DSSKey->Memory Key** (or **Line Key**).
2. In the desired memory key (or line key) field, select **ACD** from the pull-down list of **Type**.

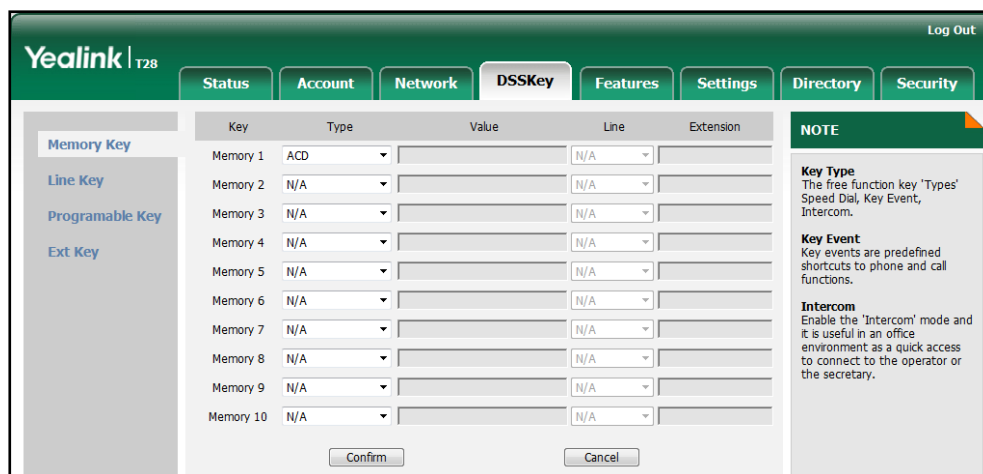

3. Click **Confirm** to accept the change.

To configure ACD auto available via web user interface:

1. Click on **Features->ACD**.
2. Select the desired line from the pull-down list of **ACD Auto Available**.

- Enter the desired time in **ACD Auto Available Timer (0~120s)** field.

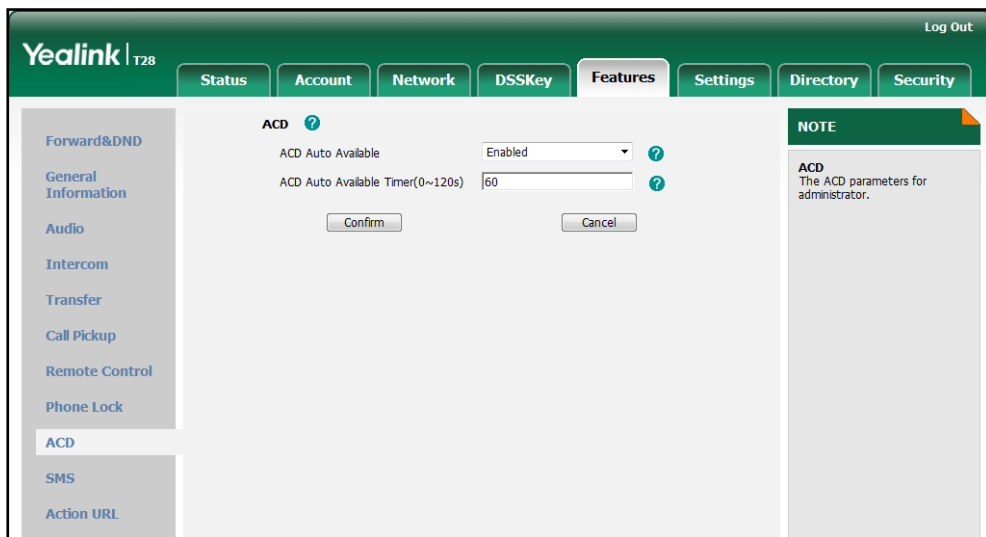

- Click **Confirm** to accept the change.

**To configure an ACD key via phone user interface:**

- Press **Menu->Features->DSS Keys->Memory Keys** (or **Line Keys**).
- Select the desired DSS key.
- Press **◀** or **▶** , or the **Switch** soft key to select **ACD** from the **Type** field.
- Press the **Save** soft key to accept the change.

## Message Waiting Indicator

Message Waiting Indicator (MWI) informs users that they have messages in their mailbox; and how many messages are waiting, without the user having to call the mailbox. IP phones support both audio and visual MWI when receiving new voice messages.

IP phones support both solicited and unsolicited MWI. Unsolicited MWI is a server related feature.

The IP phone sends a SUBSCRIBE message to the server for message-summary updates. The server sends a message-summary NOTIFY within the subscription dialog each time the MWI status changes. For solicited MWI, you must enable MWI subscription feature on IP phones. IP phones support subscribing the MWI messages to the account or the voice mail number.

IP phones do not need to subscribe for message-summary updates. The server automatically sends a message-summary NOTIFY in a new dialog each time the MWI status changes.

## Procedure

Configuration changes can be performed using the configuration files or locally.

<p><b>Configuration File</b></p>	<p>&lt;MAC&gt;.cfg</p>	<p>Configure subscribe for MWI. Configure subscribe MWI to voice mail. For more information, refer to <a href="#">Message Waiting Indicator</a> on page 325.</p>
<p><b>Local</b></p>	<p>Web User Interface</p>	<p>Configure subscribe for MWI. Configure subscribe MWI to voice mail. <b>Navigate to:</b> http://&lt;phoneIPAddress&gt;/servlet?&amp;p=account-adv&amp;q=load&amp;acc=0</p>

To configure subscribe for MWI via web user interface:

1. Click on **Account**.
2. Select the desired account from the pull-down list of **Account**.
3. Click on **Advanced**.
4. Select the desired value from the pull-down list of **Subscribe for MWI**.
5. Enter the period time in the **MWI Subscription Period (Seconds)** field.

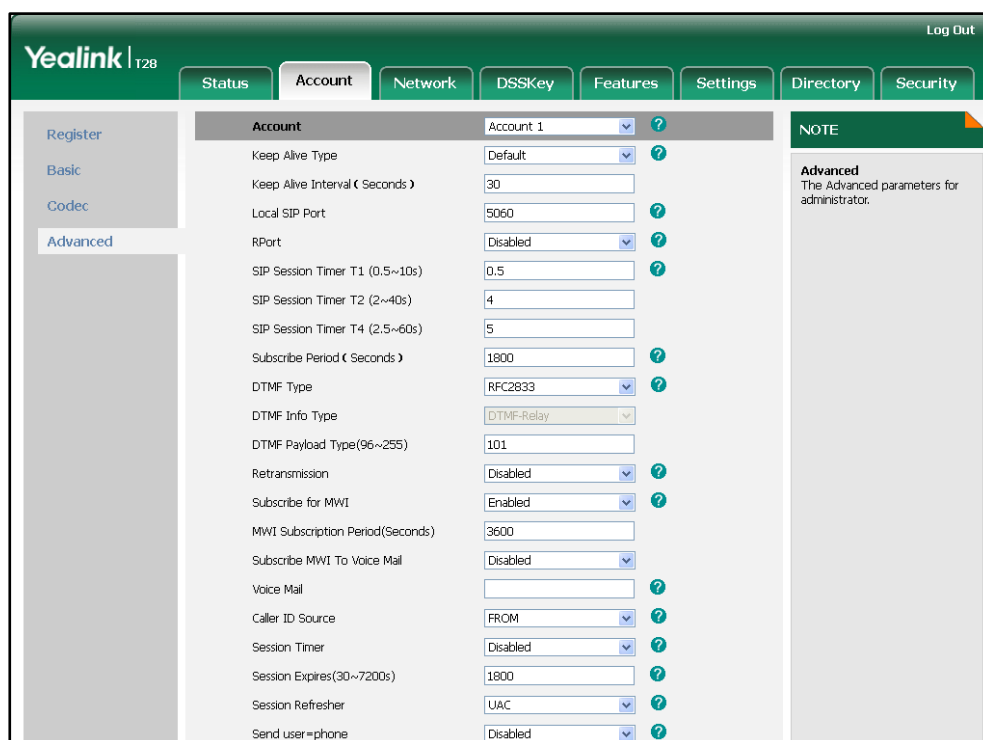

6. Click **Confirm** to accept the change.

To configure subscribe MWI to voice mail via web user interface:

1. Click on **Account**.
2. Select the desired account from the pull-down list of **Account**.
3. Click on **Advanced**.
4. Select the desired value from the pull-down list of **Subscribe MWI To Voice Mail**.
5. Enter the desired voice number in the **Voice Mail** field.

The screenshot shows the Yealink T28 web interface. The top navigation bar includes 'Status', 'Account', 'Network', 'DSSKey', 'Features', 'Settings', 'Directory', and 'Security'. The 'Account' tab is active, and the 'Advanced' sub-tab is selected. The configuration table is as follows:

Parameter	Value	Action
Account	Account 1	?
Keep Alive Type	Default	?
Keep Alive Interval (Seconds)	30	
Local SIP Port	5060	?
RPort	Disabled	?
SIP Session Timer T1 (0.5~10s)	0.5	?
SIP Session Timer T2 (2~40s)	4	
SIP Session Timer T4 (2.5~60s)	5	
Subscribe Period (Seconds)	1800	?
DTMF Type	RFC2833	?
DTMF Info Type	DTMF-Relay	
DTMF Payload Type(96~255)	101	
Retransmission	Disabled	?
Subscribe for MWI	Enabled	?
MWI Subscription Period(Seconds)	3600	
Subscribe MWI To Voice Mail	Enabled	?
Voice Mail	1234	?

A 'NOTE' box on the right states: 'Advanced: The Advanced parameters for administrator.'

6. Click **Confirm** to accept the change.

## Multicast Paging

Multicast paging allows IP phones to send/receive Real-time Transport Protocol (RTP) streams to/from the pre-configured multicast address(es) without involving SIP signaling. Up to 10 listening multicast addresses can be specified on the IP phone.

## Sending RTP Stream

Users can send an RTP stream without involving SIP signaling by pressing a configured multicast paging key. A multicast address (IP: Port) should be assigned to the multicast paging key, which is defined to transmit RTP stream to a group of designated IP phones. When the IP phone sends the RTP stream to a pre-configured multicast address, each IP phone preconfigured to listen to the multicast address can receive the RTP stream. When the originator stops sending the RTP stream, the subscribers stop receiving it. This feature is not applicable to the SIP-T19P IP phone.

## Procedure

Configuration changes can be performed using the configuration files or locally.

<p><b>Configuration File</b></p>	<p>&lt;y0000000000xx&gt;.cfg</p>	<p>Assign a multicast paging key. For more information, refer to <a href="#">Multicast Paging Key</a> on page 394. Specify a multicast codec for the IP phone to use for multicast RTP. For more information, refer to <a href="#">Sending RTP Stream</a> on page 329.</p>
<p><b>Local</b></p>	<p>Web User Interface</p>	<p>Assign a multicast paging key. <b>Navigate to:</b> http://&lt;phoneIPAddress&gt;/servlet?p=dsskey&amp;q=load&amp;model=0 Specify a multicast codec for the IP phone to use for multicast RTP. <b>Navigate to:</b> http://&lt;phoneIPAddress&gt;/servlet?p=features-general&amp;q=load</p>
	<p>Phone User Interface</p>	<p>Assign a multicast paging key.</p>

### To configure a multicast paging key via web user interface:

1. Click on **DSSKey->Memory Key** (or **Line Key**).
2. In the desired memory key (or line key) field, select **Paging** from the pull-down list of **Type**.
3. Enter the multicast IP address and port number in the **Value** field.

The valid multicast IP addresses range from 224.0.0.0 to 239.255.255.255.

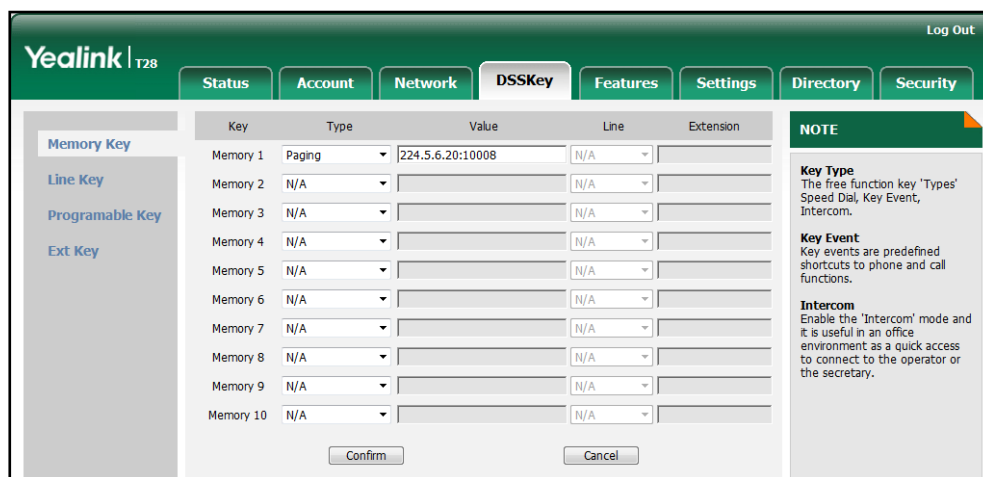



- Click **Confirm** to accept the change.

To configure a codec for multicast paging via web user interface:

- Click on **Features->General Information**.
- Select the desired codec from the pull-down list of **Multicast Codec**.

The screenshot shows the Yealink T28 web interface. The 'Features' tab is selected, and the 'General Information' sub-tab is active. The 'Multicast Codec' is set to 'G722'. Other settings include Call Waiting (Enabled), Call Waiting On Code (empty), Call Waiting Off Code (empty), Auto Redial (Disabled), Auto Redial Interval (10), Auto Redial Times (10), Multicast Codec (G722), Play Hold Tone (Enabled), Play Hold Tone Delay (30), Allow Mute (Enabled), Call List Show Number (Disabled), Voice Mail Tone (Enable), DHCP Hostname (SIP-T28P), and Reboot In Talking (Disabled). There are 'Confirm' and 'Cancel' buttons at the bottom. A 'NOTE' section on the right provides details for Call Waiting, Key As Send, and Hotline Number.

- Click **Confirm** to accept the change.

To configure a multicast paging key via phone user interface:

- Press **Menu->Features->DSS Keys->Memory Keys (or Line Keys)**.
- Select the desired DSS key.
- Press **◀** or **▶**, or the **Switch** soft key to select **Key Event** from the **Type** field.
- Press **◀** or **▶**, or the **Switch** soft key to select **Multicast Paging** from the **Key Type** field.
- Enter the multicast IP address and port number in the **Value** field.
- Press the **Save** soft key to accept the change.

## Receiving RTP Stream

IP phones can receive an RTP stream from the pre-configured multicast address(es) without involving SIP signaling, and can handle the incoming multicast paging calls differently depending on the configurations of Paging Barge and Paging Priority Active.

### Paging Barge

This parameter defines the priority of the voice call in progress, and decides how the IP phone handles the incoming multicast paging calls when there is already a voice call in

progress. If the parameter is configured as disabled, all incoming multicast paging calls will be automatically ignored. If the parameter is the priority value, the incoming multicast paging calls with higher priority are automatically answered and the ones with lower priority are ignored.

### Paging Priority Active

This parameter decides how the IP phone handles the incoming multicast paging calls when there is already a multicast paging call in progress. If the parameter is configured as disabled, the IP phone will automatically ignore all incoming multicast paging calls. If the parameter is configured as enabled, an incoming multicast paging call with higher priority is automatically answered, and the one with lower priority is ignored.

### Procedure

Configuration changes can be performed using the configuration files or locally.

<p><b>Configuration File</b></p>	<p>&lt;y0000000000xx&gt;.cfg</p>	<p>Configure the listening multicast address.</p> <p>Configure Paging Barge and Paging Priority Active features.</p> <p>For more information, refer to <a href="#">Receiving RTP Stream</a> on page 330.</p>
<p><b>Local</b></p>	<p>Web User Interface</p>	<p>Configure the listening multicast address.</p> <p>Configure Paging Barge and Paging Priority Active features.</p> <p><b>Navigate to:</b></p> <p>http://&lt;phoneIPAddress&gt;/servlet?p=contacts-multicastIP&amp;q=load</p>

**To configure a listening multicast address via web user interface:**

1. Click on **Directory->Multicast IP**.
2. Enter the listening multicast address and port number in the **Listening Address** field.  
1 is the highest priority and 10 is the lowest priority.
3. Enter the label in the **Label** field.

The label will appear on the LCD screen when receiving the RTP multicast.

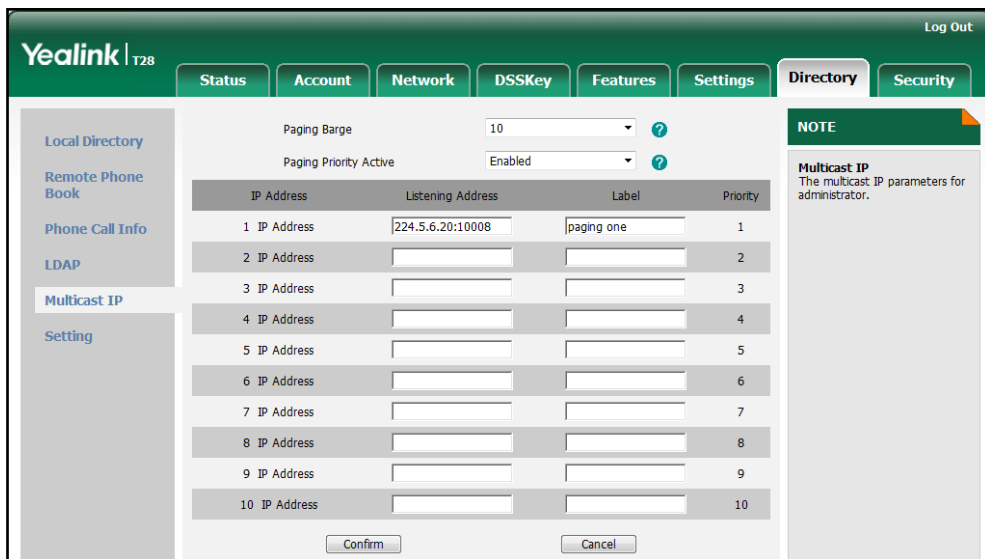

4. Click **Confirm** to accept the change.

To configure paging barge and paging priority active features via web user interface:

1. Click on **Directory->Multicast IP**.
2. Select the desired value from the pull-down list of **Paging Barge**.
3. Select the desired value from the pull-down list of **Paging Priority Active**.

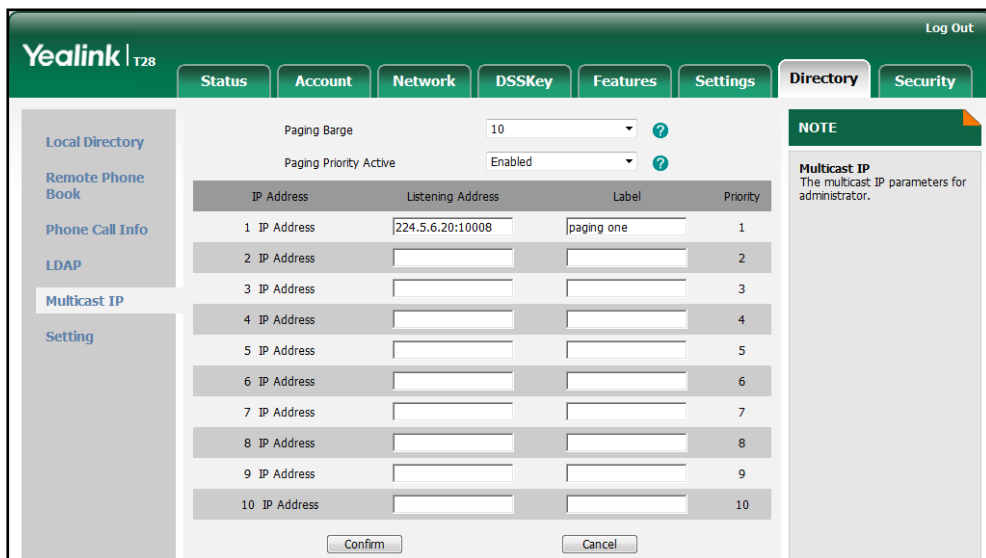

4. Click **Confirm** to accept the change.

## Call Recording

Call recording enables users to record calls. It depends on support from a SIP server. When the user presses the call record key, the IP phone sends a record request to the server. IP phones themselves do not have memory to store the recording, what they can do is to trigger the recording and indicate the recording status. This feature is not applicable to the SIP-T19P IP phone.

Normally, there are 2 main methods to trigger a recording on a certain server. We call them record and URL record. Record is for the IP phone to send the server a SIP INFO message containing a specific header. URL record is for the IP phone to send an HTTP GET message containing a specific URL to the server. The server processes these messages and decides to start or stop a recording.

### Record

When a user presses a record key for the first time during a call, the IP phone sends a SIP INFO message to the server with the specific header "Record: on", and then the recording starts.

Example of a SIP INFO message:

```
Via: SIP/2.0/UDP 10.1.4.148:5063;branch=z9hG4bK1139980711
From: "827" <sip:827@192.168.1.199>;tag=2066430997
To: <sip:614@192.168.1.199>;tag=371745247
Call-ID: 1895019940@10.1.4.148
CSeq: 2 INFO
Contact: <sip:827@10.1.4.148:5063>
Max-Forwards: 70
User-Agent: Yealink SIP-T28P 2.71.0.110
Record: on
Content-Length: 0
```

When the user presses the record key for the second time, the IP phone sends a SIP INFO message to the server with the specific header "Record: off", and then the recording stops.

Example of a SIP INFO message:

```
Via: SIP/2.0/UDP 10.1.4.148:5063;branch=z9hG4bK1619489730
From: "827" <sip:827@192.168.1.199>;tag=1831694891
To: <sip:614@192.168.1.199>;tag=2228378244
Call-ID: 1051886688@10.1.4.148
CSeq: 3 INFO
Contact: <sip:827@10.1.4.148:5063>
Max-Forwards: 70
User-Agent: Yealink SIP-T28P 2.71.0.110
```

```
Record: off
Content-Length: 0
```

## URL Record

When a user presses a URL record key for the first time during a call, the IP phone sends an HTTP GET message to the server.

Example of an HTTP GET message:

```
Get /phonerecording.cgi?model=yealink HTTP/1.0\r\n
Request Method: GET
Request URI: /phonerecording.cgi?model=yealink
Request version: HTTP/1.0
Host: 10.1.2.224\r\n
User-agent: yealink SIP-T28P 2.71.0.110 00:16:65:11:30:68\r\n
```

If the recording is successfully started, the server will respond with a 200 OK message.

Example of a 200 OK message:

```
<YealinkIPPhoneText>
<Title>
  </Title>
<Text>
  The recording session is successfully started.
  </Text>
</YealinkIPPhoneText>
```

If the recording fails for some reasons, for example, the recording box is full, the server will respond with a 200 OK message.

Example of a 200 OK message:

```
<YealinkIPPhoneText>
<Title>
  </Title>
<Text>
  Probably the recording box is full.
  </Text>
</YealinkIPPhoneText>
```

When the user presses the URL record key for the second time, the IP phone sends an HTTP GET message to the server, and then the server will respond with a 200 OK message.

Example of a 200 OK message:

```
<YealinkIPPhoneText>
<Title>
```

```

</Title>
<Text>
    The recording session is successfully stopped.
</Text>
<YealinkIPPhoneText>
    
```

### Procedure

Call recording key can be configured using the configuration files or locally.

<b>Configuration File</b>	<y0000000000xx>.cfg	Assign a record key. For more information, refer to <a href="#">Record Key</a> on page 395. Assign a URL record key. For more information, refer to <a href="#">URL Record Key</a> on page 395.
<b>Local</b>	Web User Interface	Assign a record key and URL record key. <b>Navigate to:</b> http://<phoneIPAddress>/servlet?p=dsskey&q=load&model=0
	Phone User Interface	Assign a record key and URL record key.

To configure a record key via web user interface:

1. Click on **DSSKey->Memory Key** (or **Line Key**).
2. In the desired memory key (or line key) field, select **Record** from the pull-down list of **Type**.

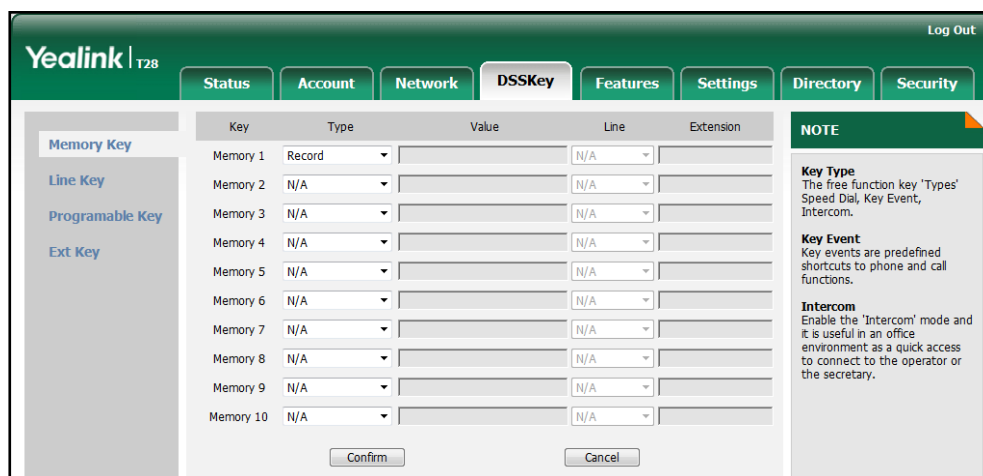

3. Click **Confirm** to accept the change.

To configure a URL record key via web user interface:

1. Click on **DSSKey->Memory Key (or Line Key)**.
2. In the desired memory key (or line key) field, select **URL Record** from the pull-down list of **Type**.
3. Enter the URL in the **Value** field.

Key	Type	Value	Line	Extension
Memory 1	URL Record	0.2.1.224//phonerecording.cgi	N/A	
Memory 2	N/A		N/A	
Memory 3	N/A		N/A	
Memory 4	N/A		N/A	
Memory 5	N/A		N/A	
Memory 6	N/A		N/A	
Memory 7	N/A		N/A	
Memory 8	N/A		N/A	
Memory 9	N/A		N/A	
Memory 10	N/A		N/A	

**NOTE**

**Key Type**  
The free function key 'Types' Speed Dial, Key Event, Intercom.

**Key Event**  
Key events are predefined shortcuts to phone and call functions.

**Intercom**  
Enable the 'Intercom' mode and it is useful in an office environment as a quick access to connect to the operator or the secretary.

4. Click **Confirm** to accept the change.

To configure a record key via phone user interface:

1. Press **Menu->Features->DSS Keys->Memory Keys (or Line Keys)**.
2. Select the desired DSS key.
3. Press **◀** or **▶**, or the **Switch** soft key to select **Key Event** from the **Type** field.
4. Press **◀** or **▶**, or the **Switch** soft key to select **Record** from the **Key Type** field.
5. Press the **Save** soft key to accept the change.

To configure a URL record key via phone user interface:

1. Press **Menu->Features->DSS Keys->Memory Keys (or Line Keys)**.
2. Select the desired DSS key.
3. Press **◀** or **▶**, or the **Switch** soft key to select **URL Record** from the **Type** field.
4. Enter the URL in the **Value** field.
5. Press the **Save** soft key to accept the change.

## Hot Desking

Hot desking originates from the definition of being the temporary physical occupant of a work station or surface by a particular employee. A primary motivation for hot desking is cost reduction. Hot desking is regularly used in places where not all employees are in the office at the same time, or not in the office for long periods at a time, which means actual personal offices would often be vacant, consuming valuable

space and resources.

Hot desking allows a user to clear registration configurations of all accounts on the IP phone, and then register his account on line 1. In order to use this feature, you need to assign a hot desking key.

### Procedure

Hot desking key can be configured using the configuration files or locally.

<b>Configuration File</b>	<y0000000000xx>.cfg	Assign a hot desking key. For more information, refer to <a href="#">Hot Desking Key</a> on page 396.
<b>Local</b>	Web User Interface	Assign a hot desking key. <b>Navigate to:</b> http://<phoneIPAddress>/servlet?p=dsskey&q=load&model=0
	Phone User Interface	Assign a hot desking key.

To configure a hot desking key via web user interface:

1. Click on **DSSKey->Memory Keys (Line Key or Programmable Key)**.
2. In the desired DSS key field, select **Hot Desking** from the pull-down list of **Type**.

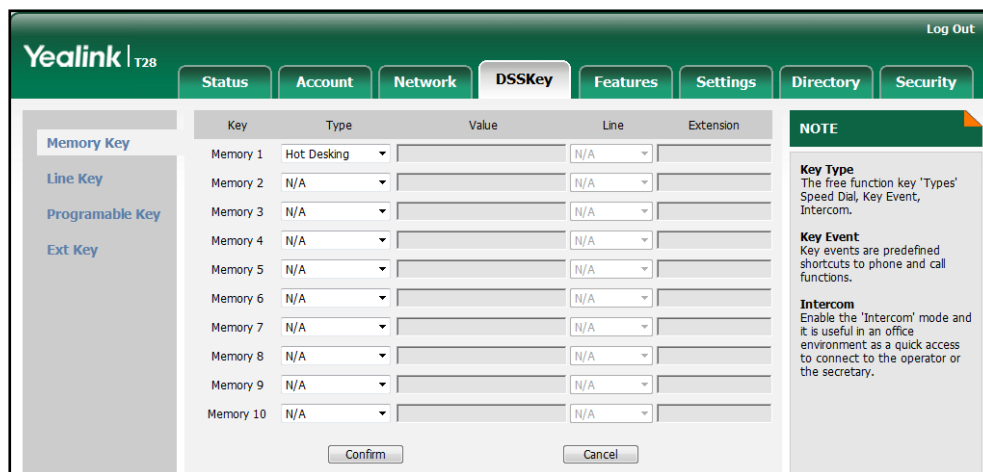

3. Click **Confirm** to accept the change.

To configure a hot desking key via phone user interface:

1. Press **Menu->Features->DSS Keys->Memory Keys (or Line Keys)**.
2. Select the desired DSS key.
3. Press **◀** or **▶**, or the **Switch** soft key to select **Key Event** from the **Type** field.
4. Press **◀** or **▶**, or the **Switch** soft key to select **Hot Desking** from the **Key Type** field.



5. Press the **Save** soft key to accept the change.

## Action URL

Action URL allows IP phones to interact with web server applications by sending an HTTP or HTTPS GET request. You can specify a URL that triggers a GET request when a specified event occurs. Action URL can only be triggered by the pre-defined events (e.g., log on). The valid URL format is: `http(s)://IP address of the server/help.xml?`.

The following table lists the pre-defined events for action URL.

Event	Description
Setup Completed	When the IP phone completes startup.
Registered	When the IP phone successfully registers an account.
Unregistered	When the IP phone logs off the registered account.
Register Failed	When the IP phone fails to register an account.
Off Hook	When the IP phone is off hook.
On Hook	When the IP phone is on hook.
Incoming Call	When the IP phone receives an incoming call.
Outgoing Call	When the IP phone places a call.
Established	When the IP phone establishes a call.
Terminated	When the IP phone terminates a call.
Open DND	When the IP phone enables the DND mode.
Close DND	When the IP phone disables the DND mode.
Open Always Forward	When the IP phone enables the always forward.
Close Always Forward	When the IP phone disables the always forward.
Open Busy Forward	When the IP phone enables the busy forward.
Close Busy Forward	When the IP phone disables the busy forward.
Open No Answer Forward	When the IP phone enables the no answer forward.
Close No Answer Forward	When the IP phone disables the no answer forward.
Transfer Call	When the IP phone transfers a call.
Blind Transfer	When the IP phone blind transfers a call.
Attended Transfer	When the IP phone performs the semi-attended/attended transfer.
Hold	When the IP phone places a call on hold.
UnHold	When the IP phone retrieves a hold call.

Event	Description
Mute	When the IP phone mutes a call.
UnMute	When the IP phone un-mutes a call.
Missed Call	When the IP phone misses a call.
IP Changed	When the IP address of the IP phone changes.
Forward Incoming Call	When the IP phone forwards an incoming call.
Reject Incoming Call	When the IP phone rejects an incoming call.
Answer New-In Call	When the IP phone answers a new call.
Transfer Finished	When the IP phone completes to transfer a call.
Transfer Failed	When the IP phone fails to transfer a call.
Idle To Busy	When the state of the IP phone changes from idle to busy.
Busy To Idle	When the state of phone changes from busy to idle.
Call Interrupt	When the IP phone cancels the call in the connecting interface.
Autop Finish	When the IP phone finishes auto provisioning.

An HTTP or HTTPS GET request may contain variable name and variable value, separated by “=”. Each variable value starts with \$ in the query part of the URL. The valid URL format is: `http(s)://IP address of server/help.xml?variable name=$variable`. Variable name can be customized by users, while the variable value is pre-defined. For example, a URL `http://192.168.1.10/help.xml?mac=$mac` is specified for the event Mute, \$mac will be dynamically replaced with the MAC address of the IP phone when the IP phone mutes a call.

The following table lists pre-defined variable values.

Variable Value	Description
\$mac	The MAC address of the IP phone
\$ip	The IP address of the IP phone
\$model	The IP phone model
\$firmware	The firmware version of the IP phone
\$active_url	The SIP URI of the current account when the IP phone places a call, receives an incoming call or establishes a call.
\$active_user	The user part of the SIP URI for the current account when the IP phone places a call, receives an incoming call or establishes a call.

Variable Value	Description
\$active_host	The host part of the SIP URI for the current account when the IP phone places a call, receives an incoming call or establishes a call.
\$local	The SIP URI of the caller when the IP phone places a call. The SIP URI of the callee when the IP phone receives an incoming call.
\$remote	The SIP URI of the callee when the IP phone places a call. The SIP URI of the caller when the IP phone receives an incoming call.
\$display_local	The display name of the caller when the IP phone places a call. The display name of the callee when the IP phone receives an incoming call.
\$display_remote	The display name of the callee when the IP phone places a call. The display name of the caller when the IP phone receives an incoming call.
\$call_id	The call-id of the active call.

## Procedure

Action URL can be configured using the configuration files or locally.

<b>Configuration File</b>	<y0000000000xx>.cfg	Configure action URL. For more information, refer to <a href="#">Action URL</a> on page 331.
<b>Local</b>	Web User Interface	Configure action URL. <b>Navigate to:</b> http://<phoneIPAddress>/servlet?p=features-actionurl&q=load

To configure action URL via web user interface:

1. Click on **Features->Action URL**.

2. Enter the action URLs in the corresponding fields.

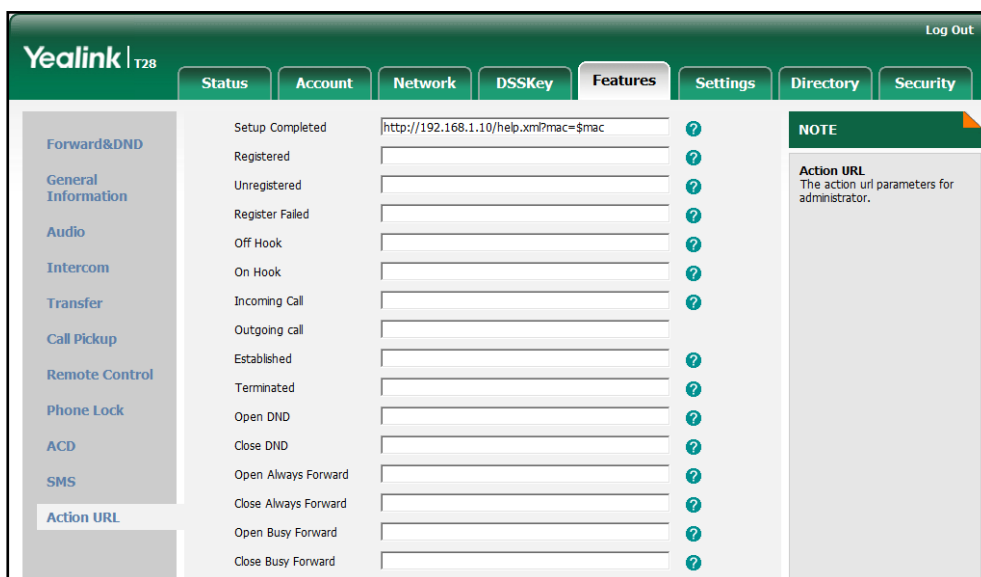

3. Click **Confirm** to accept the change.

## Action URI

Opposite to action URL, action URI allows IP phones to interact with web server application by receiving and handling an HTTP or HTTPS GET request. When receiving a GET request, the IP phone will perform the specified action and respond with a 200 OK message. A GET request may contain variable named as "key" and variable value, separated by "=" . The valid URI format is: http(s)://phone IP address/servlet?key=variable value.

The following table lists pre-defined variable values:

Variable Value	Phone Action
OK	Press the OK key (For SIP-T19P, press  ).
ENTER	Press the Enter soft key (Except for SIP-T20P).
SPEAKER	Press the Speakerphone key.
F_TRANSFER	Transfers a call to another party.
VOLUME_UP	Increase the volume.
VOLUME_DOWN	Decrease the volume.
MUTE	Mute the call.
F_HOLD	Place an active call on hold.
X	Cancel actions or reject incoming calls (For SIP-T22P/T21P/T20P, also mute or un-mute calls).

Variable Value	Phone Action
0-9/*/POUND	Press the keypad (0-9, * or #).
L1-LX	Press the line keys (Except for SIPT19P, for SIP-T28P, X=6, for SIP-T26/22P, X=3, for SIP-T21P/T20P, X=2).
D1-D10	Press the memory keys (Only for SIPT28/T26P).
F_CONFERENCE	Press the CONF key (Except for SIPT22P/T21P/T19P) or the Conference soft key (Except for SIP-T20P).
F1-F4	Press the soft keys (Except for SIPT20P).
MSG	Press the MESSAGE key.
HEADSET	Press the HEADSET key.
RD	Press the RD key.
UP/DOWN/LEFT/RIGHT	Press the navigation keys.
Reboot	Reboot the IP phone. <b>Note:</b> The IP phone cannot reboot during a call by default.
AutoP	Perform auto provisioning.
DNDOn	Activate the DND feature.
DNDOff	Deactivate the DND feature.

**Note**

The variable value does not work with all events. For example, the variable value "MUTE" is only applicable when the IP phone is during a call.

For security reasons, IP phones do not receive and handle HTTP/HTTPS GET requests by default. You need to specify the trusted IP address for action URI. When the IP phone receives a GET request from the trusted IP address for the first time, the LCD screen prompts the message "Allow Remote Control?". You can specify one or more trusted IP addresses on the IP phone, or configure the IP phone to receive and handle the URI from any IP address.

**Procedure**

Specify the trusted IP address for action URI using the configuration files or locally.

<b>Configuration File</b>	<y0000000000xx>.cfg	Specify the trusted IP address(es) for sending the action URI to the IP phone. For more information, refer to <a href="#">Action URI</a> on page 333.
---------------------------	---------------------	--

<p><b>Local</b></p>	<p>Web User Interface</p>	<p>Specify the trusted IP address(es) for sending the action URI to the IP phone.</p> <p><b>Navigate to:</b></p> <p>http://&lt;phoneIPAddress&gt;/servlet?p=features-remotecontrol&amp;q=load</p> <p>Configure reboot in talking feature.</p> <p><b>Navigate to:</b></p> <p>http://&lt;phoneIPAddress&gt;/servlet?p=features-general&amp;q=load</p>
---------------------	---------------------------	---

**To configure the trusted IP address(es) for action URI via web user interface:**

1. Click on **Features->Remote Control**.
2. Enter the IP address or any in the **Action URI allow IP List** field.

Multiple IP addresses are separated by comma. If you enter "any" in this field, the IP phone can receive and handle GET requests from any IP address. If you leave the field blank, the IP phone cannot receive or handle any HTTP GET request.

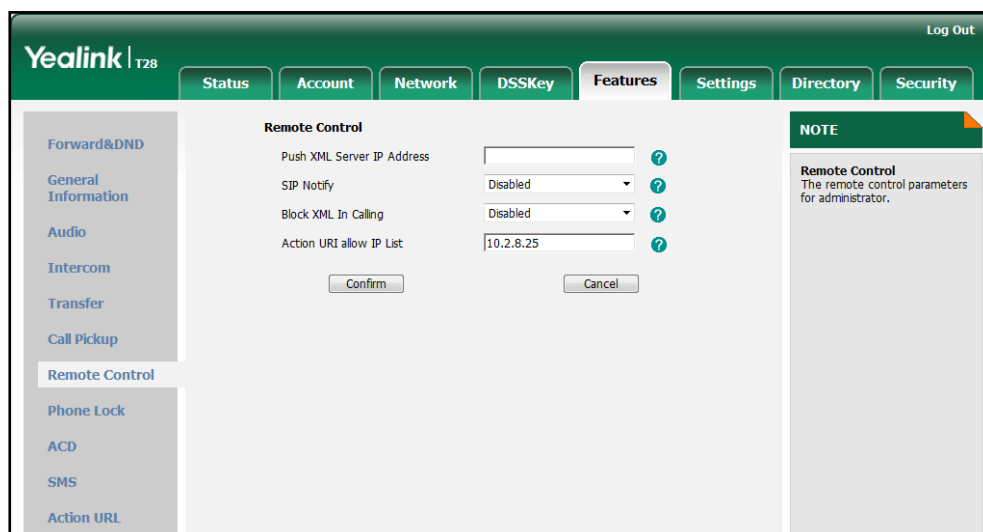

3. Click **Confirm** to accept the change.

**To configure reboot in talking feature via web user interface:**

1. Click on **Features->General Information**.

- Select the desired value from the pull-down list of **Reboot In Talking**.

The screenshot shows the Yealink T28 web interface with the 'Features' tab selected. The 'General Information' section contains the following settings:

Setting	Value
Call Waiting	Enabled
Call Waiting On Code	
Call Waiting Off Code	
Auto Redial	Disabled
Auto Redial Interval (1~300s)	10
Auto-Logout Time(1~1000min)	5
Call Number Filter	,
Use Logo	System logo
Allow IP Call	Enable
IP Direct Auto Answer	Disabled
Call List Show Number	Disabled
Voice Mail Tone	Enable
DHCP Hostname	SIP-T28P
Reboot In Talking	Enable

The 'NOTE' section on the right contains the following information:

- Call Waiting**: This call feature allows your phone to accept other incoming calls during the conversation.
- Key As Send**: Select \* or # as the send key.
- Hotline Number**: When you pick up the phone, it will dial out the hotline number automatically.

- Click **Confirm** to accept the change.

## Server Redundancy

Server redundancy is often required in VoIP deployments to ensure continuity of phone service, for events where the server needs to be taken offline for maintenance, the server fails, or the connection between the IP phone and the server fails.

Two types of redundancy are possible. In some cases, a combination of the two may be deployed:

- Failover**: In this mode, the full phone system functionality is preserved by having a second equivalent capability call server take over from the one that has gone down/off-line. This mode of operation should be done using the DNS mechanism from the primary to the secondary server.
- Fallback**: In this mode, a second less featured call server with SIP capability takes over call control to provide basic calling capability, but without some advanced features offered by the working server (for example, shared line, call recording and MWI). IP phones support configuration of two SIP servers per SIP registration for fallback purpose.

### Phone Configuration for Redundancy Implementation

To assist in explaining the redundancy behavior, an illustrative example of how an IP phone may be configured is shown next. In the example, server redundancy for fallback and failover purposes is deployed. Two separate SIP servers (a working server

and a fallback server) are configured for per line registration.

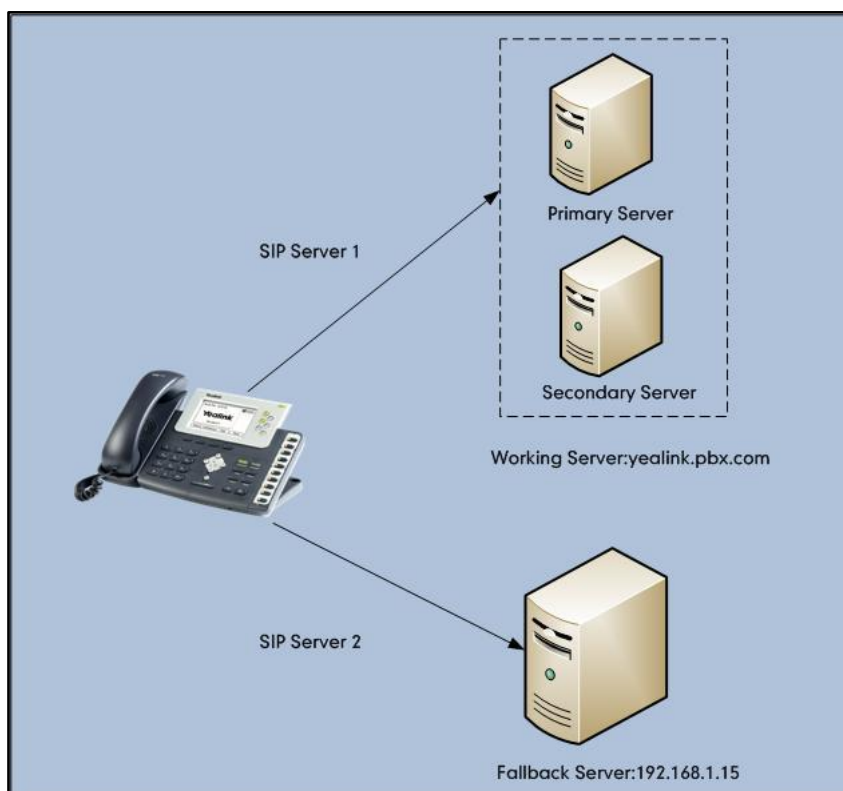

**Working Server:** Server 1 is configured with the domain name of the working server. For example, yealink.pbx.com. DNS mechanism is used such that the working server is resolved to multiple SIP servers for failover purpose. The working server is deployed in redundant pairs, designated as primary and secondary servers. The primary server has the highest priority server in a cluster of servers resolved by the DNS server. The secondary server backs up a primary server when the primary server fails and offers the same functionality as the primary server.

**Fallback Server:** Server 2 is configured with the IP address of the fallback server. For example, 192.168.1.15. A fallback server offers lesser functionality than the working server.

## Phone Registration

Registration methods of the fallback mode include:

- **Concurrent registration:** The IP phone registers to two SIP servers (working server and fallback server) at the same time. In a failure situation, a fallback server can take over the basic calling capability, but without some of the richer features offered by the working server (default registration method).
- **Successive registration:** The IP phone only registers to one server at a time. The IP phone first registers to the working server. In a failure situation, the IP phone registers to the fallback server.

When registering to the working server, the IP phone must always register to the primary server first except in failover conditions. When the primary server registration is



unavailable, the secondary server will serve as the working server.

### Procedure

Server redundancy can be configured using the configuration files or locally.

<b>Configuration File</b>	<MAC>.cfg	Configure the server redundancy on the IP phone. For more information, refer to <a href="#">Server Redundancy</a> on page 334.
<b>Local</b>	Web User Interface	Configure the server redundancy on the IP phone. <b>Navigate to:</b> http://<phoneIPAddress>/servlet?p=account-register&q=load&acc=0

To configure server redundancy and transport type via web user interface:

1. Click on **Account->Register**.
2. Select the desired account from the pull-down list of **Account**.
3. Select the desired value from the pull-down list of **Transport**.
4. Configure parameters of the SIP server 1 and SIP server 2 in the corresponding fields.

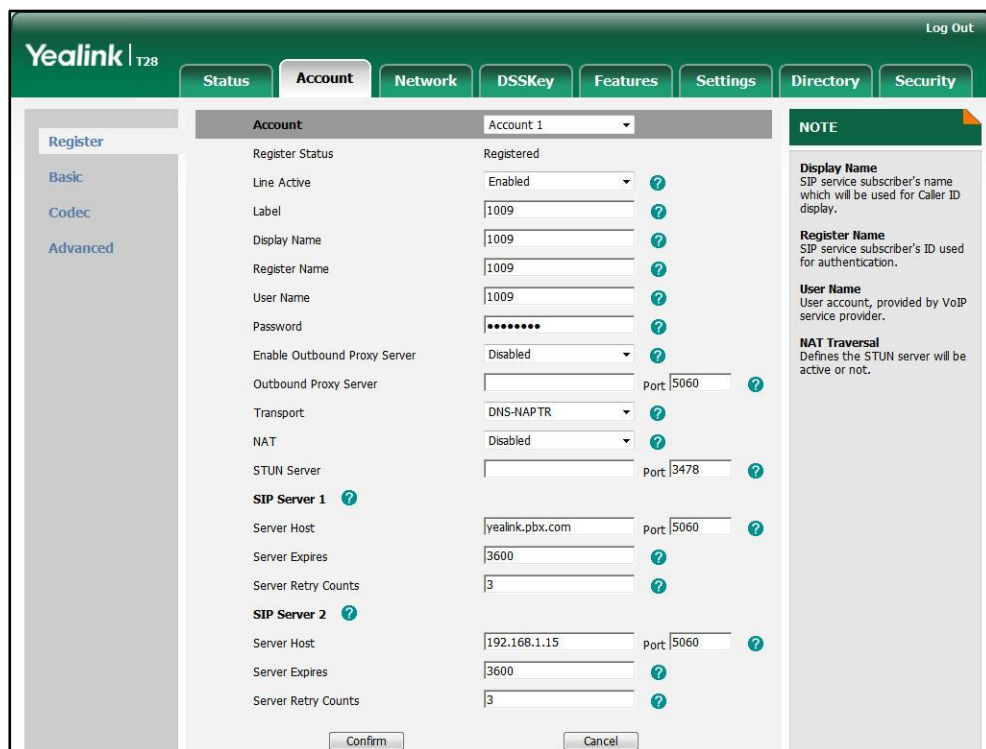

5. Click **Confirm** to accept the change.

## SIP Server Domain Name Resolution

If a domain name is configured for a SIP server, the IP address(es) associated with that domain name will be resolved through DNS as specified by RFC 3263. The DNS query involves NAPTR, SRV and A queries, which allows the IP phone to adapt to various deployment environments. The IP phone performs NAPTR query for the NAPTR pointer and transport protocol (UDP, TCP and TLS), the SRV query on the record returned from the NAPTR for the target domain name and the port number, and the A query for the IP addresses.

If an explicit port (except 0) is specified and the transport type is set to DNS-NAPTR, A query will be performed only. If a SIP server port is set to 0 and the transport type is set to DNS-NAPTR, NAPTR and SRV queries will be tried before falling to A query. If no port is found through the DNS query, 5060 will be used.

The following details the procedures of DNS query for the IP phone to resolve the domain name (e.g., yealink.pbx.com) of working server into the IP address, port and transport protocol.

### NAPTR (Naming Authority Pointer)

First, the IP phone sends NAPTR query to get the NAPTR pointer and transport protocol.

Example of NAPTR records:

	order	pref	flags	service	regexp	replacement
IN NAPTR	90	50	"s"	"SIP+D2T"	""	_sip._tcp.yealink.pbx.com
IN NAPTR	100	50	"s"	"SIP+D2U"	""	_sip._udp.yealink.pbx.com

Parameters are explained in the following table:

Parameter	Description
order	Specify preferential treatment for the specific record. The order is from lowest to highest, lower order is more preferred.
pref	Specify the preference for processing multiple NAPTR records with the same order value. Lower value is more preferred.
flags	The flag "s" means to perform an SRV lookup.
service	Specify the transport protocols: SIP+D2U: SIP over UDP SIP+D2T: SIP over TCP SIP+D2S: SIP over SCTP SIPS+D2T: SIPS over TCP
regexp	Always empty for SIP services.
replacement	Specify a domain name for the next query.

The IP phone picks the first record, because its order of 90 is lower than 100. The pref parameter is unimportant as there is no other record with order 90. The flag "s" indicates performing the SRV query next. TCP will be used, targeted to a host determined by an SRV query of "\_sip.\_tcp.yealink.pbx.com". If the flag of the NAPTR record returned is empty, the IP phone will perform NAPTR query again according to the previous NAPTR query result.

### SRV (Service Location Record)

The IP phone performs an SRV query on the record returned from the NAPTR for the host name and the port number. Example of SRV records:

	Priority	Weight	Port	Target
IN SRV	0	1	5060	server1.yealink.pbx.com
IN SRV	0	2	5060	server2.yealink.pbx.com

Parameters are explained in the following table:

Parameter	Description
Priority	Specify preferential treatment for the specific host entry. Lower priority is more preferred.
Weight	When priorities are equal, weight is used to differentiate the preference. The preference is from highest to lowest. Again, keep the same to load balance.
Port	Identify the port number to be used.
Target	Identify the actual host for an A query.

SRV query returns two records. The two SRV records point to different hosts and have the same priority 0. The weight of the second record is higher than the first one, so the second record will be picked first. The two records also contain a port "5060", the IP phone uses this port. If the Target is not a numeric IP address, the IP phone performs an A query. So in this case, the IP phone uses "server1.yealink.pbx.com" and "server2.yealink.pbx.com" for the A query.

### A (Host IP Address)

The IP phone performs an A query for the IP address of each target host name. Example of A records:

```
Server1.yealink.pbx.com IN A    62.10.1.10
Server2.yealink.pbx.com IN A    62.10.1.20
```

The IP phone picks the IP address "62.10.1.20" first.

## Outgoing Call When the Working Server Connection Fails

When a user initiates a call, the phone will go through the following steps to connect the call:

1. Sends the INVITE request to the primary server.
2. If the primary server does not respond correctly to the INVITE, then tries to make the call using the secondary server.
3. If the secondary server is also unavailable, the IP phone will try the fallback server until it either succeeds in making a call or exhausts all servers at which point the call will fail.

At the start of a call, server availability is determined by SIP signaling failure. SIP signaling failure depends on the SIP protocol being used as described below:

- If TCP is used, then the signaling fails if the connection or the send fails.
- If UDP is used, then the signaling fails if ICMP is detected or if the signal times out. If the signaling has been attempted through all servers in the list and this is the last server, then the signaling fails after the complete UDP timeout defined in RFC 3261. If it is not the last server in the list, the maximum number of retries depends on the configured retry count.

### Procedure

SIP server domain name resolution can be configured using the configuration files or locally.

<b>Configuration File</b>	<MAC>.cfg	Configure the transport type. For more information, refer to <a href="#">SIP Server Domain Name Resolution</a> on page 337.
---------------------------	-----------	--

Local	Web User Interface	Configure the transport type. <b>Navigate to:</b> <a href="http://&lt;phoneIPAddress&gt;/servlet?p=account-register&amp;q=load&amp;acc=0">http://&lt;phoneIPAddress&gt;/servlet?p=account-register&amp;q=load&amp;acc=0</a>
-------	--------------------	---

## LLDP

LLDP (Linker Layer Discovery Protocol) is a vendor-neutral Link Layer protocol, which allows IP phones to receive and/or transmit device-related information to directly connected devices on the network that are also using the protocol, and store the information that is learned about other devices. LLDP transmits information as packets called LLDP Data Units (LLDPDUs). An LLDPDU consists of a set of Type-Length-Value (TLV) elements, each of which contains a particular type of information about the device or the port transmitting it.

### LLDP-MED (Media Endpoint Discovery)

LLDP-MED is published by the Telecommunications Industry Association (TIA). It is an extension to LLDP that operates between endpoint devices and network connectivity devices. LLDP-MED specifically provides support for voice over IP (VoIP) applications and provides the following capabilities:

- Capabilities Discovery -- allows IP phones to determine the capabilities that the connected switch supports and has enabled.
- Network Policy -- provides voice VLAN configuration to notify IP phones which VLAN to use and QoS-related configuration for voice data. It provides a “plug and play” network environment.
- Power Management -- provides information related to how IP phones are powered, power priority, and how much power IP phones need.
- Inventory Management -- provides a means to effectively manage IP phones and their attributes such as model number, serial number and software revision.

TLVs supported by IP phones are summarized in the following table:

TLV Type	TLV Name	Description
Mandatory TLVs	Chassis ID	The network address of the IP phone.
	Port ID	The MAC address of the IP phone.
	Time To Live	Seconds until data unit expires. The default value is 60s.
	End of LLDPDU	Marks end of LLDPDU.

TLV Type	TLV Name	Description
<b>Optional TLVs</b>	System Name	Name assigned to the IP phone.
	System Description	Description of the IP phone.
	System Capabilities	The supported and enabled capabilities of the IP phone. The supported capabilities are Bridge, Telephone and Router. The enabled capabilities are Bridge and Telephone by default.
	Port Description	Description of port that sends data unit.
<b>IEEE Std 802.3 Organizationally Specific TLV</b>	MAC/PHY Configuration/Status	Duplex and bit rate settings of the IP phone. The Auto Negotiation is supported and enabled by default. The advertised capabilities of PMD. Auto-Negotiation is: 100BASE-TX (full duplex mode), 100BASE-TX (half duplex mode), 10BASE-T (full duplex mode), or 10BASE-T (half duplex mode).
<b>TIA Organizationally Specific TLVs</b>	Media Capabilities	The MED device type of the IP phone and the supported LLDP-MED TLV type can be encapsulated in LLDPDU. The supported LLDP-MED TLV types are: LLDP-MED Capabilities, Network Policy, Extended Power via MDI-PD and Inventory.
	Network Policy	Port VLAN ID, application type, L2 priority and DSCP value.
	Extended Power-via-MDI	Power type, source, priority and value.
	Inventory – Hardware Revision	Hardware revision of the IP phone.
	Inventory – Firmware Revision	Firmware revision of the IP phone.
	Inventory – Software Revision	Software revision of the IP phone.
	Inventory – Serial	Serial number of the IP phone.

TLV Type	TLV Name	Description
	Number	
	Inventory – Manufacturer Name	Manufacturer name of the IP phone.
	Inventory – Model Name	Model name of the IP phone.
	Asset ID	Assertion identifier of the IP phone.

### Procedure

LLDP can be configured using the configuration files or locally.

<b>Configuration File</b>	<y0000000000xx>.cfg	Configure LLDP. For more information, refer to <a href="#">SIP Server Domain Name Resolution</a> on page 337.
<b>Local</b>	Web User Interface	Configure LLDP. <b>Navigate to:</b> http://<phoneIPAddress>/servlet?<phoneIPAddress>/network-adv&q=load

To configure LLDP via web user interface:

1. Click on **Network->Advanced**.
2. In the **LLDP** block, select the desired value from the pull-down list of **Active**.
3. Enter the desired time interval in the **Packet Interval (1~3600s)** field.

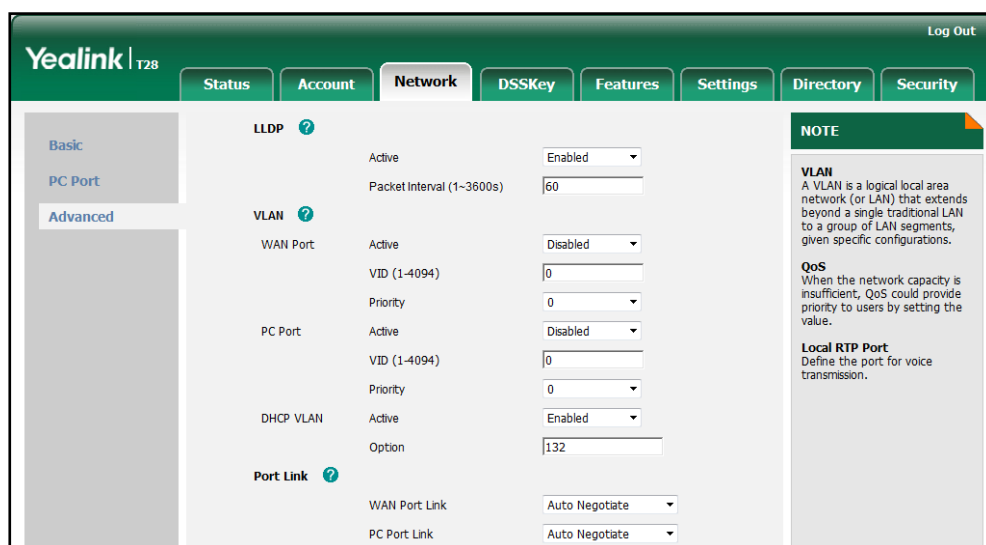

4. Click **Confirm** to accept the change.

A dialog box pops up to prompt that settings will take effect after reboot.

- Click **OK** to reboot the IP phone.

## VLAN

VLAN (Virtual Local Area Network) is used to logically divide a physical network into several broadcast domains. VLAN membership can be configured through software instead of physically relocating devices or connections. Grouping devices with a common set of requirements regardless of their physical location can greatly simplify network design. VLANs can address issues such as scalability, security and network management.

The purpose of VLAN configurations on the IP phone is to insert tag with VLAN information to the packets generated by the IP phone. When VLAN is properly configured for the ports (Internet port and PC port) on the IP phone, the IP phone will tag all packets from these ports with the VLAN ID. The switch receives and forwards the tagged packets to the corresponding VLAN according to the VLAN ID in the tag as described in IEEE Std 802.3.

VLAN on IP phones allows simultaneous access for a regular PC. This feature allows a PC to be daisy chained to an IP phone and the connection for both PC and IP phone to be trunked through the same physical Ethernet cable.

In addition to manual configuration, the IP phone also supports automatic discovery of VLAN via LLDP or DHCP. The assignment takes place in this order: assignment via LLDP, manual configuration, then assignment via DHCP.

### VLAN Discovery via DHCP

IP phones support VLAN discovery via DHCP. When the VLAN Discovery method is set to DHCP, the IP phone will examine DHCP option for a valid VLAN ID. The predefined option 132 is used to supply the VLAN ID by default. You can customize the DHCP option used to request the VLAN ID.

### Procedure

VLAN can be configured using the configuration files or locally.

<b>Configuration File</b>	<y0000000000xx>.cfg	Configure VLAN for the Internet port and PC port manually. For more information, refer to <a href="#">VLAN on page 339</a> . Configure DHCP VLAN discovery feature. For more information, refer to <a href="#">VLAN on page 339</a> .
<b>Local</b>	Web User Interface	Configure VLAN for the Internet port and PC port.



		Configure DHCP VLAN discovery feature. <b>Navigate to:</b> http://<phoneIPAddress>/servlet?<p=network-adv&q=load
	Phone User Interface	Configure VLAN for the Internet port and PC port.

**To configure VLAN for Internet port via web user interface:**

1. Click on **Network->Advanced**.
2. In the **VLAN** block, select the desired value from the pull-down list of **WAN Port Active**.
3. Enter the VLAN ID in the **VID (1-4094)** field.
4. Select the desired value (0-7) from the pull-down list of **Priority**.

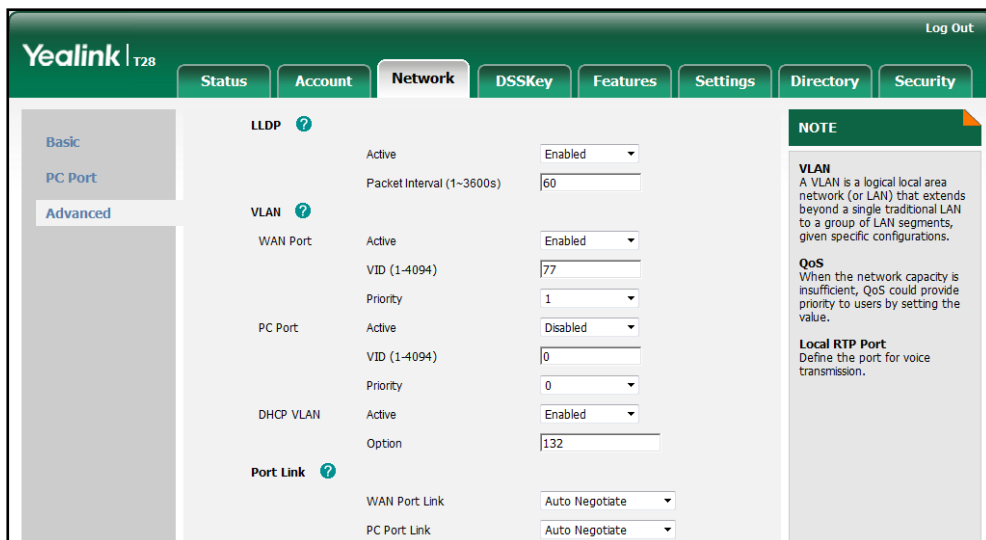

5. Click **Confirm** to accept the change.  
A dialog box pops up to prompt reboot to make the settings effective.
6. Click **OK** to reboot the IP phone.

**To configure VLAN for PC port via web user interface:**

1. Click on **Network->Advanced**.
2. In the **VLAN** block, select the desired value from the pull-down list of **PC Port Active**.
3. Enter the VLAN ID in the **VID (1-4094)** field.

- Select the desired value (0-7) from the pull-down list of **Priority**.

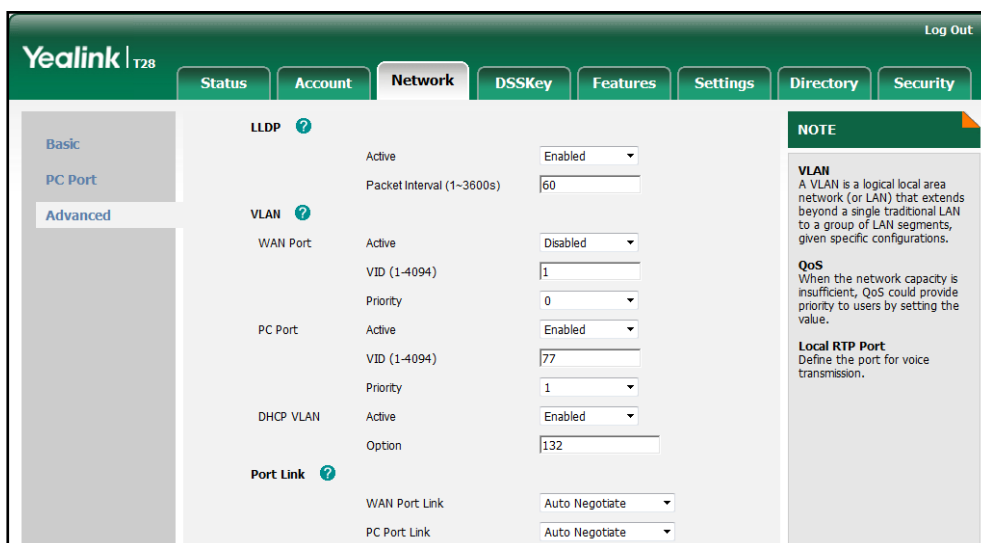

- Click **Confirm** to accept the change.  
A dialog box pops up to prompt that the settings will take effect after reboot.
- Click **OK** to reboot the IP phone.

**To configure DHCP VLAN discovery via web user interface:**

- Click on **Network->Advanced**.
- In the **VLAN** block, select the desired value from the pull-down list of **DHCP VLAN Active**.
- Enter the desired option in the **Option** field.  
The default option is 132.

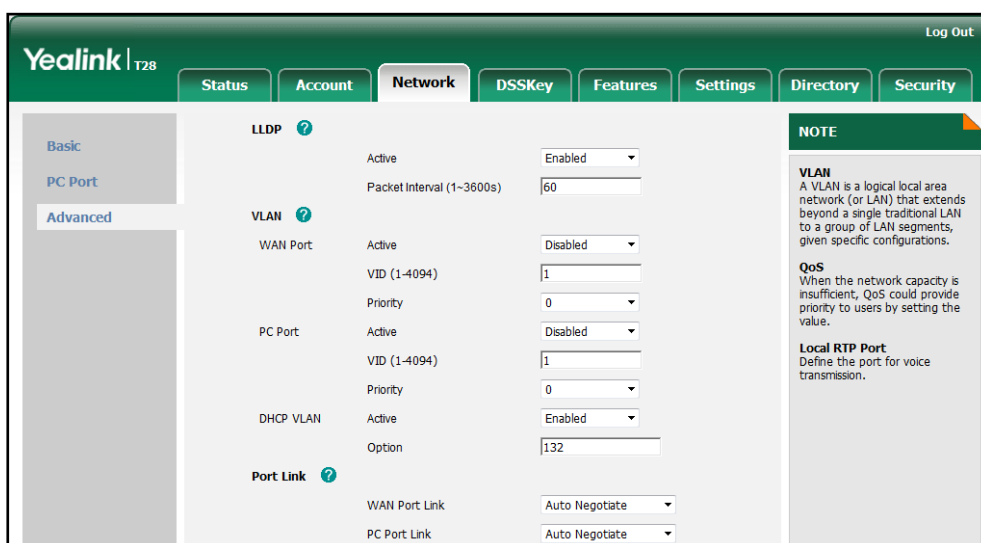

- Click **Confirm** to accept the change.  
A dialog box pops up to prompt that settings will take effect after reboot.

5. Click **OK** to reboot the IP phone.

**To configure VLAN for Internet port (or PC port) via phone user interface:**

1. Press **Menu->Settings->Advanced Settings** (password: admin)  
->**Network->VLAN->WAN Port** (or **PC Port**).
2. Press **◀** or **▶** , or the **Switch** soft key to select the desired value from the **VLAN Status** field.
3. Enter the VLAN ID (1-4094) in the **VID Number** field.
4. Enter the priority value (0-7) in the **Priority** field.
5. Press the **Save** soft key to accept the change

The IP phone reboots automatically to make settings effective after a period of time.

## VPN

VPN (Virtual Private Network) is a secured private network connection built on top of public telecommunication infrastructure, such as the Internet. It has become more prevalent due to benefits: scalability, reliability, convenience and security. VPN provides remote offices or individual users with secure access to their organization's network. Two types of VPN access: remote-access VPN (connecting an individual device to a network) and site-to-site VPN (connecting two networks together). Remote-access VPN allows employees to access their company's intranet from home or outside the office, and site-to-site VPN allows employees in geographically separated offices to share one cohesive virtual network. VPN can be also classified by the protocols used to tunnel the traffic. It provides security through tunneling protocols: IPSec, SSL, L2TP and PPTP.

IP phones support SSL VPN, which provides remote-access VPN capabilities through SSL. OpenVPN is a full featured SSL VPN software solution that creates secure connections in remote access facilities, designed to work with the TUN/TAP virtual network interface. TUN and TAP are virtual network kernel devices. TAP simulates a link layer device and provides a virtual point-to-point connection, while TUN simulates a network layer device and provides a virtual network segment. IP phones use OpenVPN to achieve VPN feature. To prevent disclosure of private information, tunnel endpoints must authenticate each other before secure VPN tunnel is established. After VPN feature is configured properly on the IP phone, the IP phone acts as a VPN client and uses the certificates to authenticate the VPN server.

### Note

VPN feature is not applicable to the SIP-T19P IP phone.

To use VPN, the compressed package of VPN-related files should be uploaded to the IP phone in advance. The file format of the compressed package must be .tar. The related VPN files are: certificates (ca.crt and client.crt), key (client.key) and the configuration file

(vpn.cnf) of the VPN client. For more information on how to package a .tar file, refer to *VPN Feature on Yealink IP Phones*.

## Procedure

VPN can be configured using the configuration files or locally.

<b>Configuration File</b>	<y0000000000xx>.cfg	Configure VPN feature and upload a tar file to the IP phone. For more information, refer to <a href="#">VPN</a> on page 342.
<b>Local</b>	Web User Interface	Configure VPN feature and upload a tar package to the IP phone. <b>Navigate to:</b> http://<phoneIPAddress>/servlet?<p=network-adv&q=load
	Phone User Interface	Configure VPN feature.

To upload a tar file and configure VPN via web user interface:

1. Click on **Network->Advanced**.
2. Click **Browse** to locate the tar file from the local system.
3. Click **Import** to import the tar file.

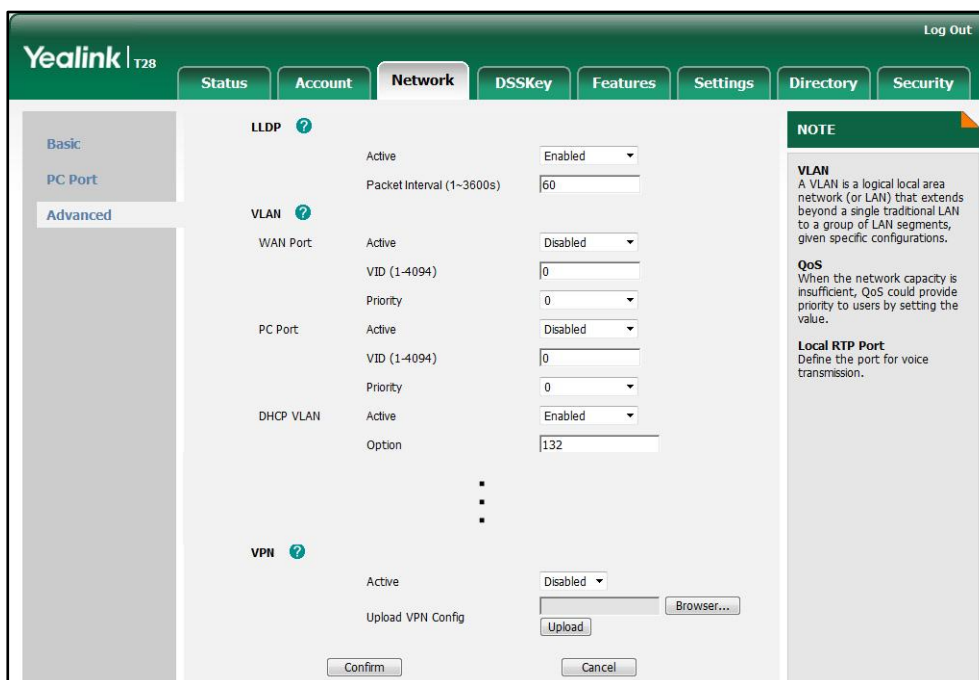



The web user interface prompts the message “Import config...”.

4. In the **VPN** block, select the desired value from the pull-down list of **Active**.

5. Click **Confirm** to accept the change.  
A dialog box pops up to prompt that settings will take effect after reboot.
6. Click **OK** to reboot the IP phone.

**To configure VPN via phone user interface after uploading the tar file:**

1. Press **Menu->Settings->Advanced Settings** (password: admin) ->**Network->VPN**.
2. Press  or  , or the **Switch** soft key to select the desired value from the **VPN Active** field.
3. Press the **Save** soft key to accept the change.

The IP phone reboots automatically to make settings effective after a period of time.

## Quality of Service

Quality of Service (QoS) is the ability to provide different priorities for different packets in the network, allowing the transport of traffic with special requirements. QoS guarantees are important for applications that require fixed bit rate and are delay sensitive when the network capacity is insufficient. Four major QoS factors to consider when configuring a modern QoS implementation: bandwidth, delay, jitter and loss.

QoS provides better network service by providing the following features:

- Supporting dedicated bandwidth
- Improving loss characteristics
- Avoiding and managing network congestion
- Shaping network traffic
- Setting traffic priorities across the network

The Best-Effort service is the default QoS model in IP networks. It provides no guarantees for data delivering, which means delay, jitter, packet loss and bandwidth allocation are unpredictable. Differentiated Services (DiffServ or DS) is the most widely supported QoS model. It provides a simple and scalable mechanism for classifying and managing network traffic and providing QoS on modern IP networks. Differentiated Services Code Point (DSCP) is used to define DiffServ classes and stored in the first six bits of the ToS (Type of Service) field. Each router on the network can provide QoS simply based on the DiffServ class. The DSCP value ranges from 0 to 63 with each DSCP specifying a particular per-hop behavior (PHB) applicable to a packet. A PHB refers to the packet scheduling, queuing, policing, or shaping behavior of a node on any given packet.

Four standard PHBs available to construct a DiffServ-enabled network and achieve QoS:

- **Class Selector PHB** -- backwards compatible with IP precedence. Class Selector code points are of the form "xxx000". The first three bits are the IP precedence bits. These PHBs retain almost the same forwarding behavior as nodes that implement IP-precedence based classification and forwarding.
- **Expedited Forwarding PHB** -- the key ingredient in DiffServ model for providing a low-loss, low-latency, low-jitter and assured bandwidth service.
- **Assured Forwarding PHB** -- defines a method by which BAs (Bandwidth Allocations) can be given different forwarding assurances.
- **Default PHB** -- specifies that a packet marked with a DSCP value of "000000" gets the traditional best effort service from a DS-compliant node.

VoIP is extremely bandwidth- and delay-sensitive. QoS is a major issue in VoIP implementations, regarding how to guarantee that packet traffic not be delayed or dropped due to interference from other lower priority traffic. VoIP can guarantee high-quality QoS only if the voice and the SIP packets are given priority over other kinds of network traffic. IP phones support the DiffServ model of QoS.

### Voice QoS

For VoIP transmissions to be intelligible to receivers, voice packets should not be dropped, excessively delayed, or made to suffer varying delay. DiffServ model can guarantee high-quality voice transmission when the voice packets are configured to a higher DSCP value.

### SIP QoS

SIP protocol is used for creating, modifying and terminating two-party or multi-party sessions. To ensure good voice quality, SIP packets emanating from IP phones should be configured with a high transmission priority.

DSCPs for voice and SIP packets can be specified respectively.

### Procedure

QoS can be configured using the configuration files or locally.

<b>Configuration File</b>	<y0000000000xx>.cfg	Configure the DSCPs for voice packets and SIP packets. For more information, refer to <a href="#">QoS on page 343</a> .
<b>Local</b>	Web User Interface	Configure the DSCPs for voice packets and SIP packets. <b>Navigate to:</b> http://<phoneIPAddress>/servl

		et?p=network-adv&q=load
--	--	-------------------------

To configure DSCPs for voice packets and SIP packets via web user interface:

1. Click on **Network->Advanced**.
2. Enter the desired value in the **Voice QoS (0~63)** field.
3. Enter the desired value in the **SIP Qos (0~63)** field.

The screenshot shows the Yealink T28 web interface. The 'Network' tab is selected, and the 'Advanced' sub-tab is active. The configuration table is as follows:

Section	Parameter	Value
LLDP	Active	Enabled
	Packet Interval (1-3600s)	60
VLAN	WAN Port Active	Disabled
	VID (1-4094)	0
	Priority	0
PC Port	Active	Disabled
	VID (1-4094)	0
	Priority	0
DHCP VLAN	Active	Enabled
	Option	132
Port Link	WAN Port Link	Auto Negotiate
	PC Port Link	Auto Negotiate
Voice QoS	Voice QoS (0~63)	46
	SIP Qos (0~63)	26

**NOTE**  
**VLAN**  
 A VLAN is a logical local area network (or LAN) that extends beyond a single traditional LAN to a group of LAN segments, given specific configurations.  
**QoS**  
 When the network capacity is insufficient, QoS could provide priority to users by setting the value.  
**Local RTP Port**  
 Define the port for voice transmission.

4. Click **Confirm** to accept the change.  
 A dialog box pops up to prompt that settings will take effect after reboot.
5. Click **OK** to reboot the IP phone.

## Network Address Translation

Network Address Translation (NAT) is essentially a translation table that maps public IP address and port combinations to private ones. This reduces the need for a large number of public IP addresses. NAT ensures security since each outgoing or incoming request must first go through a translation process. But in the VoIP environment, NAT breaks end-to-end connectivity.

### NAT Traversal

NAT traversal is a general term for techniques that establish and maintain IP connections traversing NAT gateways, typically required for client-to-client networking applications, especially for VoIP deployments. STUN is one of the NAT traversal techniques supported by IP phones.

## STUN (Simple Traversal of UDP over NATs)

STUN is a network protocol, used in NAT traversal for applications of real-time voice, video, messaging, and other interactive IP communications. The STUN protocol allows applications to operate behind a NAT to discover the presence of the network address translator, and to obtain the mapped (public) IP address and port number that the NAT has allocated for the UDP connections to remote parties. The protocol requires assistance from a third-party network server (STUN server) usually located on public Internet. The IP phone can be configured to act as a STUN client, to send exploratory STUN messages to the STUN server. The STUN server uses those messages to determine the public IP address and port used, and then informs the client.

The NAT traversal and STUN server are configurable on a per-line basis.

### Procedure

NAT traversal and STUN server can be configured using the configuration files or locally.

<b>Configuration File</b>	<MAC>.cfg	Configure NAT traversal and STUN server on the IP phone. For more information, refer to <a href="#">Network Address Translation</a> on page 343.
<b>Local</b>	Web User Interface	Configure NAT traversal and STUN server on the IP phone. <b>Navigate to:</b> http://<phoneIPAddress>/servlet?p=account-register&q=load&acc=0

**To configure NAT traversal and STUN server via web user interface:**

1. Click on **Account->Register**.
2. Select the desired account from the pull-down list of **Account**.
3. Select **STUN** from the pull-down list of **NAT**.



4. Enter the IP address or the domain name of the STUN server in the **STUN Server** field.

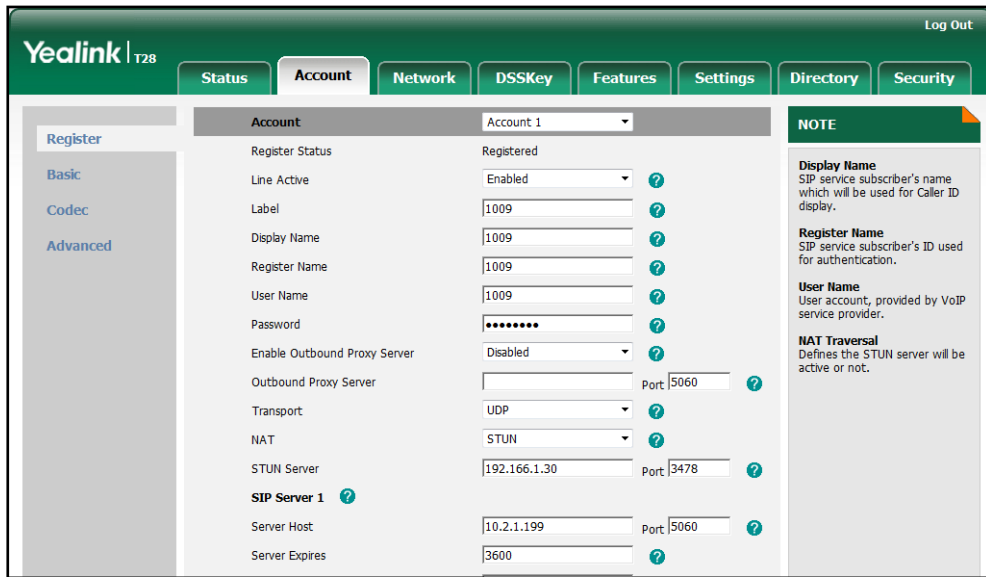

5. Click **Confirm** to accept the change.

## SNMP

SNMP (Simple Network Management Protocol) is an Internet-standard protocol for managing devices on IP networks. It is used mostly in network management systems to monitor network-attached devices for conditions that warrant administrative attention. SNMP exposes management data in the form of variables on the managed systems, which describe the system configuration, and can then be queried by the managing applications. The variables accessible via SNMP are organized in hierarchies, which are described by Management Information Bases (MIBs).

IP phones only support SNMPv1 and SNMPv2. They act as SNMP clients, receiving requests from the SNMP server. The SNMP server may send requests from any available source port to the configured port on the client, while the client responds to the source port on the SNMP server. IP phones only support the GET request from the SNMP server.

The following table lists the basic object identifiers (OIDs) supported by IP phones.

MIB	OID	Description
YEALINK-MIB	1.3.6.1.2.1.37459.2.1.1.0	The textual identification of the contact person for the IP phone, together with the contact information.  For example, Sysadmin (root@localhost)
YEALINK-MIB	1.3.6.1.2.1.37459.2.1.2.0	An administratively-assigned name for the IP phone. If the name is

MIB	OID	Description
		unknown, the value is a zero-length string. For example, IPPHONE
YEALINK-MIB	1.3.6.1.2.1.37459.2.1.3.0	The physical location of the IP phone. For example, Server Room
YEALINK-MIB	1.3.6.1.2.1.37459.2.1.4.0	The time (in milliseconds) since the network management portion of the system was last re-initialized.
YEALINK-MIB	1.3.6.1.2.1.37459.2.1.5.0	The firmware version of the IP phone.
YEALINK-MIB	1.3.6.1.2.1.37459.2.1.6.0	The hardware version of the IP phone.
YEALINK-MIB	1.3.6.1.2.1.37459.2.1.7.0	The IP phone's model.
YEALINK-MIB	1.3.6.1.2.1.37459.2.1.8.0	The MAC address of the IP phone.
YEALINK-MIB	1.3.6.1.2.1.37459.2.1.9.0	The IP address of the IP phone.
YEALINK-MIB	1.3.6.1.2.1.37459.2.1.10.0	The target version to which the current version is automatically updated. Format: MacVersion[*]ComVersion[*] For example, MacVersion[0.0.0.1]ComVersion[0.0.0.1]

## Procedure

SNMP can be configured using the configuration files or locally.

<b>Configuration File</b>	<y0000000000xx>.cfg	Configure SNMP and specify the trusted IP address. For more information, refer to <a href="#">SNMP</a> on page 344.
<b>Local</b>	Web User Interface	Configure SNMP and specify the trusted IP address. <b>Navigate to:</b> http://<phoneIPAddress>/servlet?p=network-adv&q=load

**To configure SNMP and specify the trusted IP address via web user interface:**

1. Click on **Network->Advanced**.
2. In the **SNMP** block, select the desired value from the pull-down list of **Active**.

- Enter the desired port in the **Port (0~65535)** field.
- Enter IP address(es) or domain name in the **Trusted Address** field.  
Multiple IP addresses are separated by a space.

The screenshot shows the Yealink T28 web interface with the 'Network' tab selected. The 'VLAN' section is expanded, showing the following settings:

- LLDP:** Active (Enabled), Packet Interval (1~3600s) (60)
- VLAN:** WAN Port (Active, Disabled), VID (1-4094) (0), Priority (0), PC Port (Active, Disabled)
- SNMP:** Active (Enabled), Port (0~65535) (5116), Trusted Address (192.168.1.30)
- VPN:** Active (Disabled), Upload VPN Config (Upload, Browser...)

A 'NOTE' section on the right provides additional information:

- VLAN:** A VLAN is a logical local area network (or LAN) that extends beyond a single traditional LAN to a group of LAN segments, given specific configurations.
- QoS:** When the network capacity is insufficient, QoS could provide priority to users by setting the value.
- Local RTP Port:** Define the port for voice transmission.

The interface includes a 'Log Out' button in the top right corner and a 'Confirm' button at the bottom.

- Click **Confirm** to accept the change.  
A dialog box pops up to prompt that settings will take effect after reboot.
- Click **OK** to reboot the IP phone.

## 802.1X Authentication

IEEE 802.1X authentication is an IEEE standard for Port-based Network Access Control (PNAC), part of the IEEE 802.1 group of networking protocols. It offers an authentication mechanism for devices to connect/link to a LAN or WLAN. The 802.1X authentication involves three parties: a supplicant, an authenticator and an authentication server. The supplicant is the IP phone that wishes to attach to the LAN or WLAN. With 802.1X port-based authentication, the IP phone provides credentials, such as user name and password, to the authenticator, and then the authenticator forwards the credentials to the authentication server for verification. If the authentication server determines the credentials are valid, the IP phone is allowed to access resources located on the protected side of the network.

IP phones support protocols EAP-MD5, EAP-TLS, PEAP-MSCHAPv2 and EAP-TTLS/EAP-MSCHAPv2 for 802.1X authentication.

## Procedure

802.1X authentication can be configured using the configuration files or locally.

<b>Configuration File</b>	<y0000000000xx>.cfg	Configure the 802.1X authentication. For more information, refer to <a href="#">802.1X</a> on page 346.
<b>Local</b>	Web User Interface	Configure the 802.1X authentication. <b>Navigate to:</b> http://<phoneIPAddress>/servlet?p=network-adv&q=load
	Phone User Interface	Configure the 802.1X authentication.

To configure the 802.1X authentication via web user interface:

1. Click on **Network->Advanced**.
2. In the **802.1x** block, select the desired protocol from the pull-down list of **Mode 802.1x**.
  - a) If you select **EAP-MD5**:
    - 1) Enter the user name for authentication in the **Identity** field.
    - 2) Enter the password for authentication in the **MD5 Password** field.

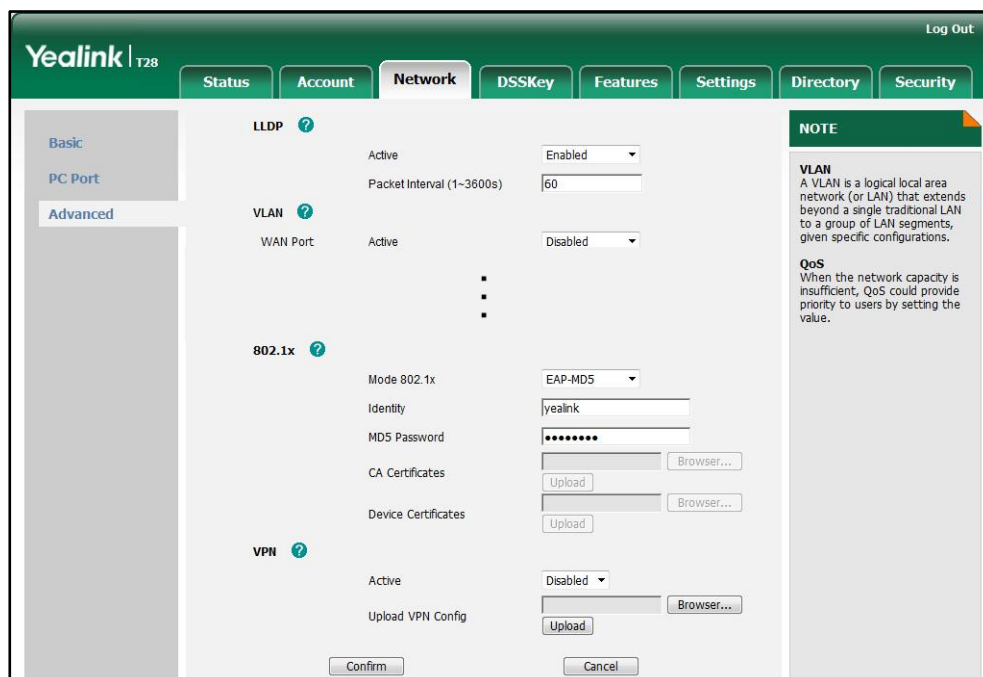

b) If you select **EAP-TLS**:

- 1) Enter the user name for authentication in the **Identity** field.
- 2) Leave the **MD5 Password** field blank.
- 3) In the **CA Certificates** field, click **Browse** to select the desired CA certificate (\*.pem, \*.crt, \*.cer or \*.der) from your local system.
- 4) In the **Device Certificates** field, click **Browse** to select the desired client (\*.pem or \*.cer) certificate from your local system.
- 5) Click **Upload** to upload the certificates.

The screenshot shows the Yealink T28 Network configuration page. The 'Network' tab is selected, and the 'Advanced' sub-tab is active. The '802.1x' section is expanded, showing the following settings:

- LLDP**: Active, Enabled (dropdown), Packet Interval (1-3600s): 60
- VLAN**: Active, Disabled (dropdown)
- 802.1x**: Mode 802.1x: EAP-TLS (dropdown), Identity: yealink, MD5 Password: [redacted], CA Certificates: [Browse...], Device Certificates: [Browse...]
- VPN**: Active, Disabled (dropdown), Upload VPN Config: [Browse...]

Buttons for 'Upload' and 'Confirm' are visible at the bottom of the configuration area. A 'NOTE' box on the right side of the page provides information about VLAN and QoS.

c) If you select **PEAP-MSCHAPv2**:

- 1) Enter the user name for authentication in the **Identity** field.
- 2) Enter the password for authentication in the **MD5 Password** field.
- 3) In the **CA Certificates** field, click **Browse** to select the desired CA certificate (\*.pem, \*.crt, \*.cer or \*.der) from your local system.

- 4) Click **Upload** to upload the certificate.

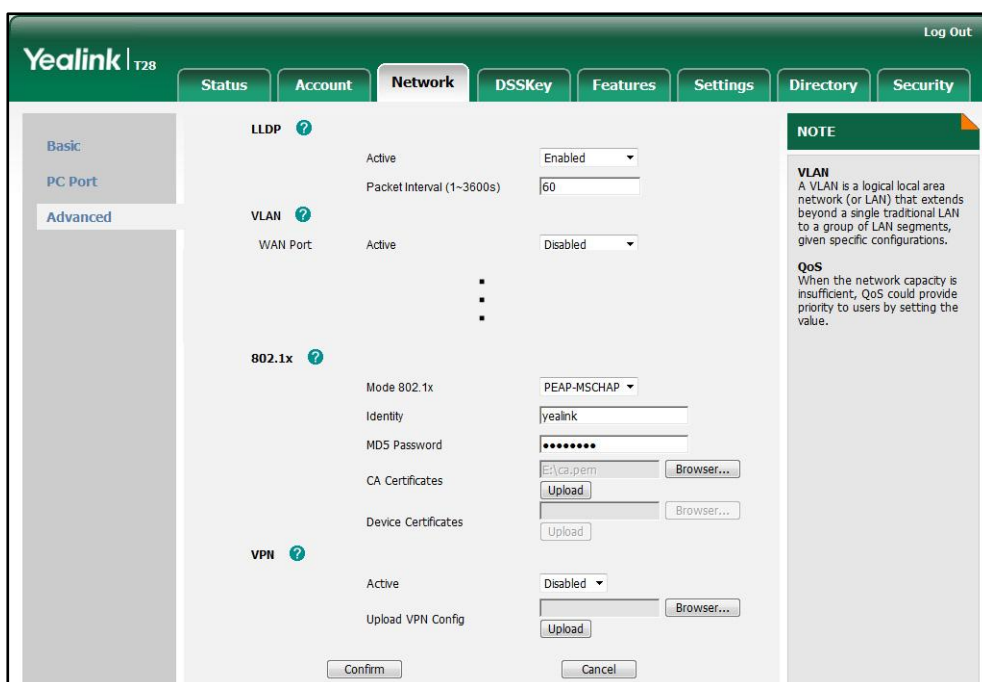

- d) If you select **EAP-TTLS/EAP-MSCHAPv2**:

- 1) Enter the user name for authentication in the **Identity** field.
- 2) Enter the password for authentication in the **MD5 Password** field.
- 3) In the **CA Certificates** field, click **Browse** to select the desired CA certificate (\*.pem, \*.crt, \*.cer or \*.der) from your local system.
- 4) Click **Upload** to upload the certificate.

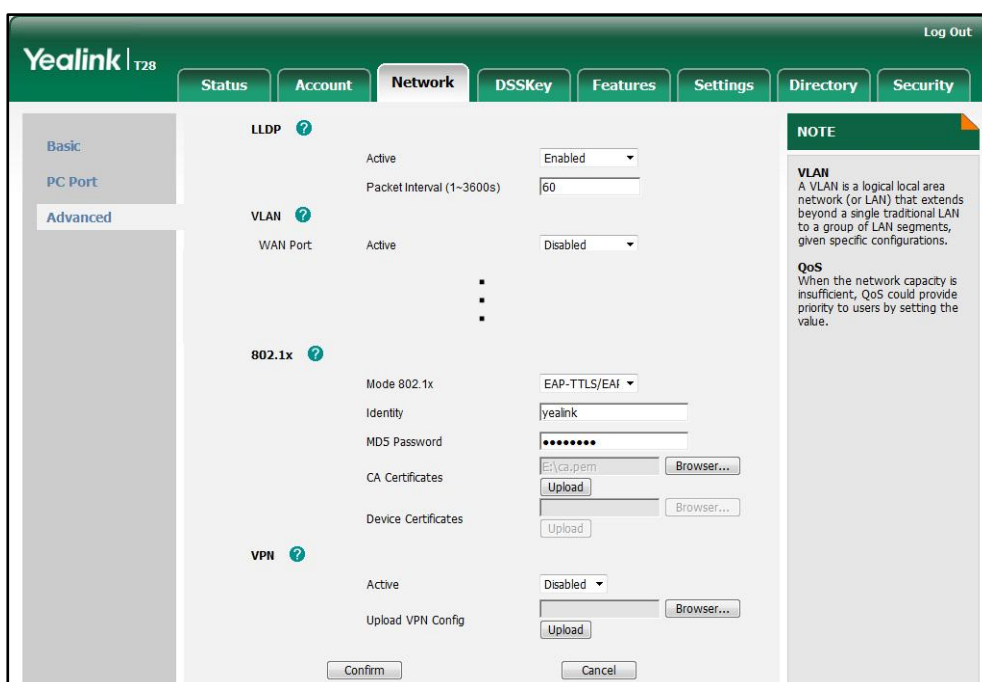



3. Click **Confirm** to accept the change.

A dialog box pops up to prompt that settings will take effect after reboot.

4. Click **OK** to reboot the IP phone.

**To configure the 802.1X authentication via phone user interface after:**

1. Press **Menu->Settings->Advanced Settings** (password: admin)  
->**Network->802.1x Settings**.
2. Press  or  , or the **Switch** soft key to select the desired value from the **802.1x Mode** field.
  - a) If you select **EAP-MD5**:
    - 1) Enter the user name for authentication in the **Identity** field.
    - 2) Enter the password for authentication in the **MD5 Password** field.
  - b) If you select **EAP-TLS**:
    - 1) Enter the user name for authentication in the **Identity** field.
    - 2) Leave the **MD5 Password** field blank.
  - c) If you select **PEAP-MSCHAPv2**:
    - 1) Enter the user name for authentication in the **Identity** field.
    - 2) Enter the password for authentication in the **MD5 Password** field.
  - d) If you select **EAP-TTLS/EAP-MSCHAPv2**:
    - 1) Enter the user name for authentication in the **Identity** field.
    - 2) Enter the password for authentication in the **MD5 Password** field.
3. Click **Save** to accept the change.

The IP phone reboots automatically to make the settings effective after a period of time.

## TR-069 Device Management

TR-069 is a technical specification, defined by the Broadband Forum, which defines a mechanism that encompasses secure auto-configuration of a CPE (Customer-Premises Equipment), as well as incorporates other CPE management functions into a common framework. TR-069 uses common transport mechanisms (HTTP and HTTPS) for communication between CPE and ACS (Auto Configuration Servers). The HTTP(S) messages contain XML-RPC methods defined in the standard for configuration and management of the CPE.

TR-069 is intended to support a variety of functionalities to manage a collection of CPEs, including the following primary capabilities:

- Auto-configuration and dynamic service provisioning
- Software or firmware image management
- Status and performance monitoring
- Diagnostics

The following table provides a description of RPC methods supported by IP phones.

RPC Method	Description
GetRPCMethods	This method is used to discover the set of methods supported by the CPE.
SetParameterValues	This method is used to modify the value of one or more CPE parameters.
GetParameterValues	This method is used to obtain the value of one or more CPE parameters.
GetParameterNames	This method is used to discover the parameters accessible on a particular CPE.
GetParameterAttributes	This method is used to read the attributes associated with one or more CPE parameters.
SetParameterAttributes	This method is used to modify attributes associated with one or more CPE parameters.
Reboot	This method causes the CPE to reboot.
Download	This method is used to cause the CPE to download a specified file from the designated location. File types supported by IP phones are: <ul style="list-style-type: none"> <li>• Firmware Image</li> <li>• Configuration File</li> </ul>
Upload	This method is used to cause the CPE to upload a specified file to the designated location. File types supported by IP phones are: <ul style="list-style-type: none"> <li>• Configuration File</li> <li>• Log File</li> </ul>
ScheduleInform	This method is used to request the CPE to schedule a one-time Inform method call (separate from its periodic Inform method calls) sometime in the future.
FactoryReset	This method resets the CPE to its factory default state.
TransferComplete	This method informs the ACS of the completion (either successful or unsuccessful) of a file transfer initiated by an earlier Download or Upload method call.
AddObject	This method is used to add a new instance of an object defined on the CPE.
DeleteObject	This method is used to remove a particular instance



RPC Method	Description
	of an object.

### Procedure

TR-069 can be configured using the configuration files or locally.

<b>Configuration File</b>	<y0000000000xx>.cfg	Configure TR-069 feature. For more information, refer to <a href="#">TR-069</a> on page 348.
<b>Local</b>	Web User Interface	Configure TR-069 feature. <b>Navigate to:</b> http://<phoneIPAddress>/servlet?<phoneIPAddress>=settings-preference&q=load

#### To configure TR-069 via web user interface:

1. Click on **Settings->TR069**.
2. Select **Enabled** from the pull-down list of **Enable TR069**.
3. Enter the user name and password authenticated by the ACS in the **ACS Username** and **ACS Password** fields.
4. Enter the URL of the ACS in the **ACS URL** field.
5. Select the desired value from the pull-down list of **Enable Periodic Inform**.
6. Enter the desired time in the **Periodic Inform Interval (seconds)** field.
7. Enter the user name and password authenticated by the IP phone in the **Connection Request Username** and **Connection Request Password** fields.

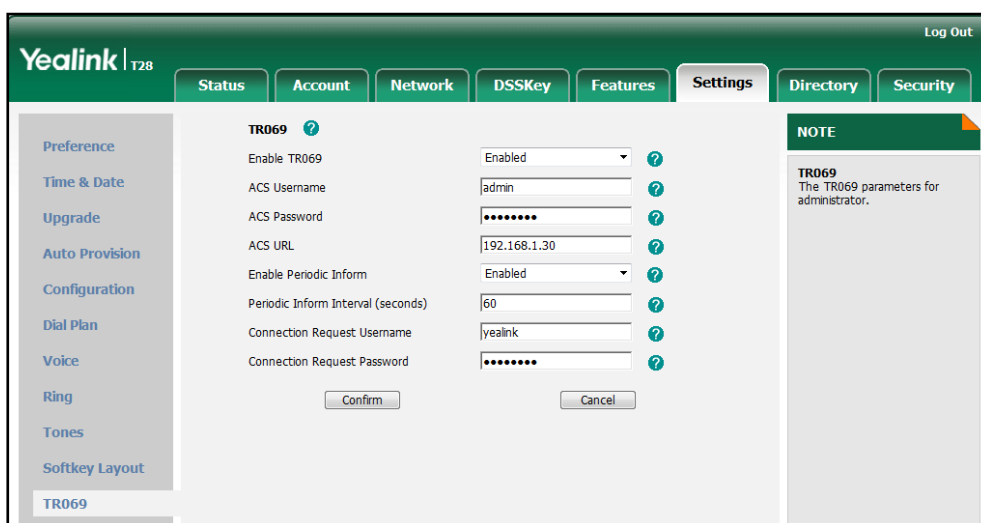

8. Click **Confirm** to accept the change.

## IPv6 Support

IPv6 is the next generation network layer protocol, designed as a replacement for the current IPv4 protocol. IPv6 was developed by the Internet Engineering Task Force (IETF) to deal with the long-anticipated problem of IPv4 address exhaustion. IPv6 uses a 128-bit address, consisting of eight groups of four hexadecimal digits separated by colons. VoIP network based on IPv6 can ensure QoS, a set of service requirements to deliver performance guarantee while transporting traffic over the network.

### IPv6 Address Assignment Method

Supported IPv6 address assignment methods:

- **Manual Assignment:** An IPv6 address and other configuration parameters (e.g., DNS server) for the IP phone can be statically configured by an administrator.
- **Stateless Address Autoconfiguration (SLAAC):** SLAAC is one of the most convenient methods to assign IP addresses to IPv6 nodes. SLAAC requires no manual configuration of the IP phone, minimal (if any) configuration of routers, and no additional servers. To use IPv6 SLAAC, the IP phone must be connected to a network with at least one IPv6 router connected. This router is configured by the network administrator and sends out Router Advertisement announcements onto the link. These announcements can allow the on-link connected IP phone to configure itself with IPv6 address, as specified in RFC 4862.

### Procedure

IPv6 can be configured using the configuration files or locally.

<b>Configuration File</b>	<y0000000000xx>.cfg	Configure the IPv6 address assignment method. For more information, refer to <a href="#">IPv6</a> on page 351.
<b>Local</b>	Web User Interface	Configure the IPv6 address assignment method. <b>Navigate to:</b> http://<phoneIPAddress>/servlet?&p=network&q=load

**To configure IPv6 address assignment method via web user interface:**

1. Click on **Network->Basic**.
2. Select the desired address mode (IPv6 or IPv4&IPv6) from the pull-down list of **Mode (IPv4/IPv6)**.
3. In the **IPv6 Config** block, mark the **DHCP** or the **Static IP Address** radio box.

If you mark the **Static IP Address** radio box, configure the IPv6 address and other configuration parameters in the corresponding fields.

The screenshot shows the Yealink T28 web interface. The 'Network' tab is selected. The 'Internet Port' section is active, with 'Mode(IPv4/IPv6)' set to 'IPv4 & IPv6'. Under 'IPv4 Config', 'DHCP' is selected. Under 'IPv6 Config', 'Static IP Address' is selected. The IPv6 fields are filled with: IP Address: 2005:1:1:1::12, IPv6 Prefix(0~128): 64, Gateway: 2005:1:1:1::1, Primary DNS: 2005:1:1:1::89, and Secondary DNS: 2005:1:1:1::87. A 'NOTE' box on the right explains DHCP and Static IP Address configurations.

4. Click **Confirm** to accept the change.

A dialog box pops up to prompt that the settings will take effect after reboot.

5. Click **OK** to reboot the IP phone.

#### To configure IPv6 address assignment method via phone user interface:

1. Press **Menu->Settings->Advanced Settings** (password: admin) ->**Network->WAN Port**.
2. Press **←** or **→** to select **IPv4&IPv6** or **IPv6** from the **IP Mode** field.
3. Press **↑** or **↓** to highlight **IPv6** and press the **Enter** soft key.
4. Press **↑** or **↓** to select the desired IPv6 address assignment method.

If you select the **Static IPv6 Client**, configure the IPv6 address and other network parameters in the corresponding fields.

5. Press the **Save** soft key to accept the change

The IP phone reboots automatically to make settings effective after a period of time.



## Configuring Audio Features

This chapter provides information for making configuration changes for the following audio features:

- [Headset Prior](#)
- [Dual Headset](#)
- [Audio Codecs](#)
- [Acoustic Clarity Technology](#)

### Headset Prior

Headset prior allows users to use headset preferentially if a headset is physically connected to the IP phone. This feature is especially useful for permanent or full-time headset users.

#### Procedure

Headset prior can be configured using the configuration files or locally.

<b>Configuration File</b>	<y0000000000xx>.cfg	Configure headset prior. For more information, refer to <a href="#">Head Prior</a> on page 354.
<b>Local</b>	Web User Interface	Configure headset prior. <b>Navigate to:</b> http://<phoneIPAddress>/servlet ?p=features-general&q=load

**To configure headset prior via web user interface:**

1. Click on **Features->General Information**.

2. Select the desired value from the pull-down list of **Headset Prior**.

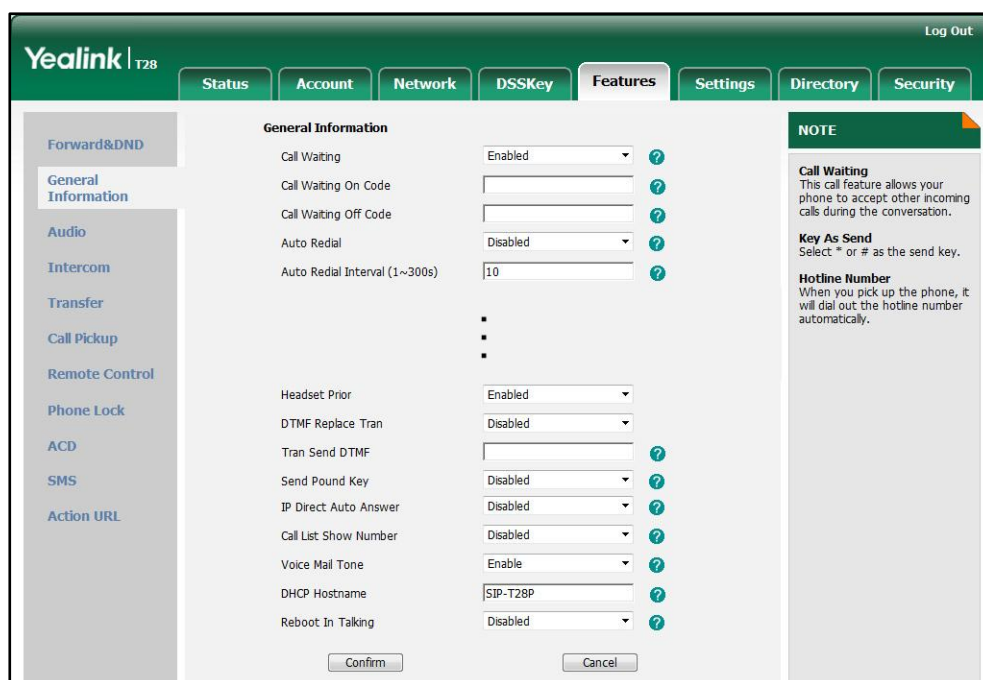

3. Click **Confirm** to accept the change.

## Dual Headset

Dual headset allows users to use two headsets on one IP phone. To use this feature, users need to physically connect two headsets to the headset and handset jacks respectively. Once the phone connects to a call, the user with the headset connected to the headset jack has full-duplex capabilities, while the user with the headset connected to the handset jack is only able to listen. This feature is not applicable to SIP-T19P and SIP-T21P IP phones.

### Procedure

Dual headset can be configured using the configuration files or locally.

<b>Configuration File</b>	<y0000000000xx>.cfg	Configure dual headset. For more information, refer to <a href="#">Dual Headset</a> on page 354.
<b>Local</b>	Web User Interface	Configure dual headset. <b>Navigate to:</b> http://<phoneIPAddress>/servlet ?p=features-general&q=load

To configure dual headset via web user interface:

1. Click on **Features->General Information**.

- Select the desired value from the pull-down list of **Dual-Headset**.

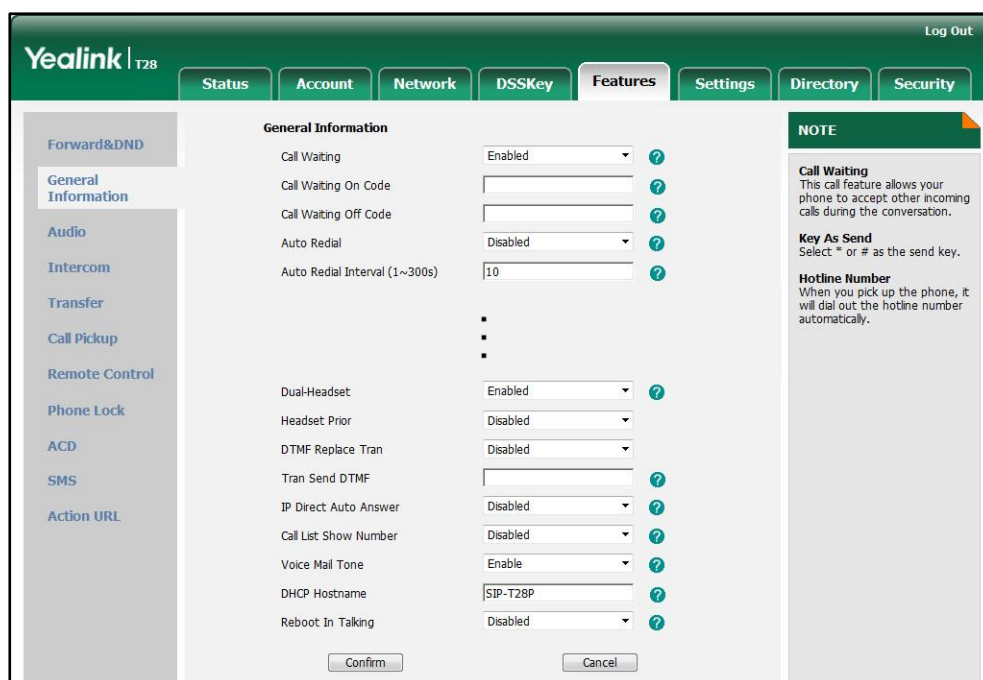

- Click **Confirm** to accept the change.

## Audio Codecs

CODEC is an abbreviation of COmpress-DECompress, capable of coding or decoding a digital data stream or signal by implementing an algorithm. The object of the algorithm is to represent the high-fidelity audio signal with minimum number of bits while retaining the quality. This can effectively reduce the frame size and the bandwidth required for audio transmission.

The default codecs used on IP phones are summarized in the following table:

Codec	Algorithm	Bit Rate	Sample Rate	Packetization Time
PCMA	G.711 a-law	64 Kbps	8 Ksps	20ms
PCMU	G.711 u-law	64 Kbps	8 Ksps	20ms
G729	G.729	8 Kbps	8 Ksps	20ms
G722	G.722	64 Kbps	16 Ksps	20ms

In addition to the codecs introduced above, IP phones also support codecs: G723\_53, G723\_63, G726\_16 (not applicable to SIP-T21P and SIP-T19P IP phones), G726\_24 (not applicable to SIP-T21P and SIP-T19P IP phones), G726\_32, G726\_40 (not applicable to SIP-T21P and SIP-T19P IP phones) and iLBC. Codecs are configurable on a per-line basis, instead of using defaults. You can also configure the priorities for these desired codecs. The attribute "rtmpmap" is used to define a mapping from RTP payload codes to a codec, clock rate and other encoding parameters.

The corresponding attributes of the codec are listed as follows:

Codec	Configuration Methods	Priority	RTPmap
PCMU	Configuration Files Web User Interface	1	0
PCMA	Configuration Files Web User Interface	2	8
G729	Configuration Files Web User Interface	3	18
G722	Configuration Files Web User Interface	4	9
G723_53	Configuration Files Web User Interface	0	4
G723_63	Configuration Files Web User Interface	0	4
G726_16	Configuration Files Web User Interface	0	112
G726_24	Configuration Files Web User Interface	0	102
G726_32	Configuration Files Web User Interface	0	99
G726_40	Configuration Files Web User Interface	0	104
iLBC	Configuration Files Web User Interface	0	102

### Packetization Time

Ptime (Packetization Time) is measurement of the duration (in milliseconds) of the audio data in each RTP packet sent to the destination, and defines how much network bandwidth is used for the RTP stream transfer. Before establishing a conversation, codec and ptime are negotiated through SIP signaling. The valid values of ptime range from 10 to 60, in increments of 10 milliseconds. The default ptime is 20ms. You can also disable the ptime negotiation.







## Procedure

Configuration changes can be performed using the configuration files or locally.

<b>Configuration File</b>	<MAC>.cfg	<p>Configure the codecs to use on a per-line basis.</p> <p>Configure the priority and rtpmap for the enabled codec.</p> <p>For more information, refer to <a href="#">Audio Codecs</a> on page 355.</p> <p>Configure the ptime.</p> <p>For more information, refer to <a href="#">Audio Codecs</a> on page 355.</p>
<b>Local</b>	Web User Interface	<p>Configure the codecs to use and adjust the priority of the enabled codecs on a per-line basis.</p> <p>Configure the ptime.</p> <p><b>Navigate to:</b></p> <p>http://&lt;phoneIPAddress&gt;/servlet?p=account-codec&amp;q=load&amp;acc=0</p>

**To configure the codecs to use and adjust the priority of the enabled codecs on a per-line basis via web user interface:**

1. Click on **Account**.
2. Select the desired account from the pull-down list of **Account**.
3. Click on **Codec**.
4. Select the desired codec from the **Disable Codecs** column and then click  .  
The selected codec appears in the **Enable Codecs** column.
5. Repeat the step 4 to add more codecs to the **Enable Codecs** column.
6. To remove the codec from the **Enable Codecs** column, select the desired codec and then click  .

- To adjust the priority of codecs, select the desired codec and then click  or  .

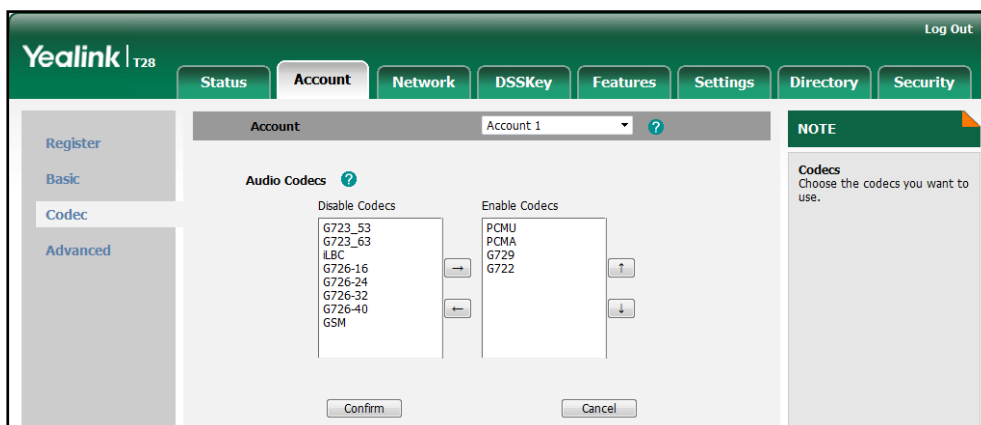

- Click **Confirm** to accept the change.

To configure the ptime on a per-line basis via web user interface:

- Click on **Account**.
- Select the desired account from the pull-down list of **Account**.
- Click on **Advanced**.
- Select the desired value from the pull-down list of **PTime (ms)**.

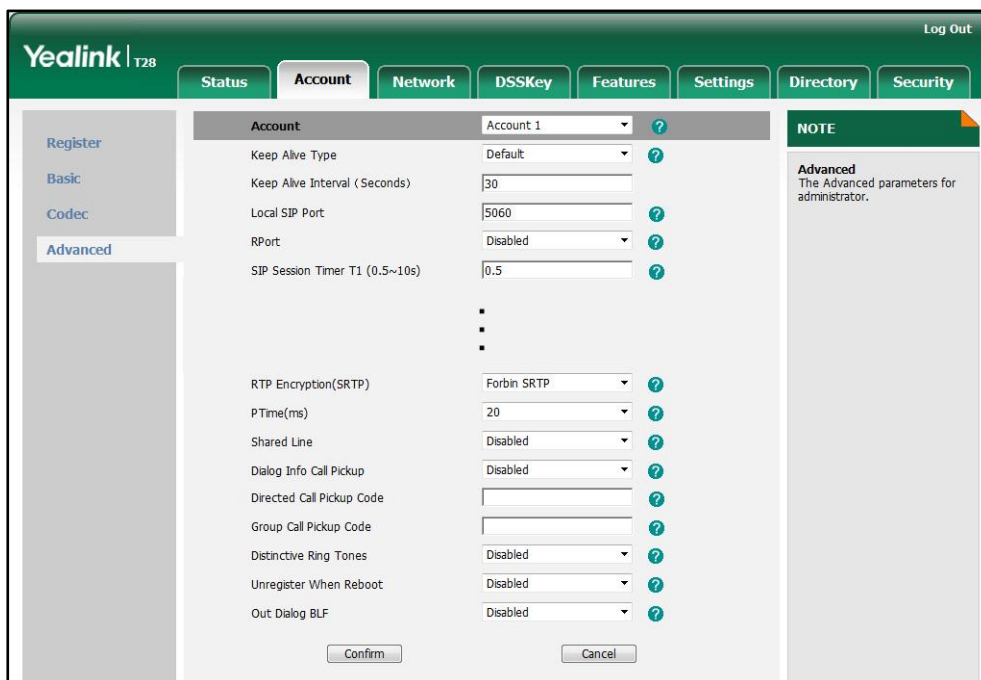

- Click **Confirm** to accept the change.

# Acoustic Clarity Technology

## Acoustic Echo Cancellation

Acoustic Echo Cancellation (AEC) is used to remove acoustic echo from a voice communication in order to improve the voice quality. It also increases the capacity achieved through silence suppression by preventing echo from traveling across a network. IP phones employ advanced AEC for hands-free operation. Echo cancellation is achieved using the echo canceller.

### Procedure

AEC can be configured using the configuration files or locally.

<b>Configuration File</b>	<y0000000000xx>.cfg	Configure AEC. For more information, refer to <a href="#">Acoustic Echo Cancellation</a> on page 359.
<b>Local</b>	Web User Interface	Configure AEC. <b>Navigate to:</b> http://<phoneIPAddress>/servlet?p=settings-voice&q=load

To configure AEC via web user interface:

1. Click on **Settings->Voice**.
2. Select the desired value from the pull-down list of **ECHO**.

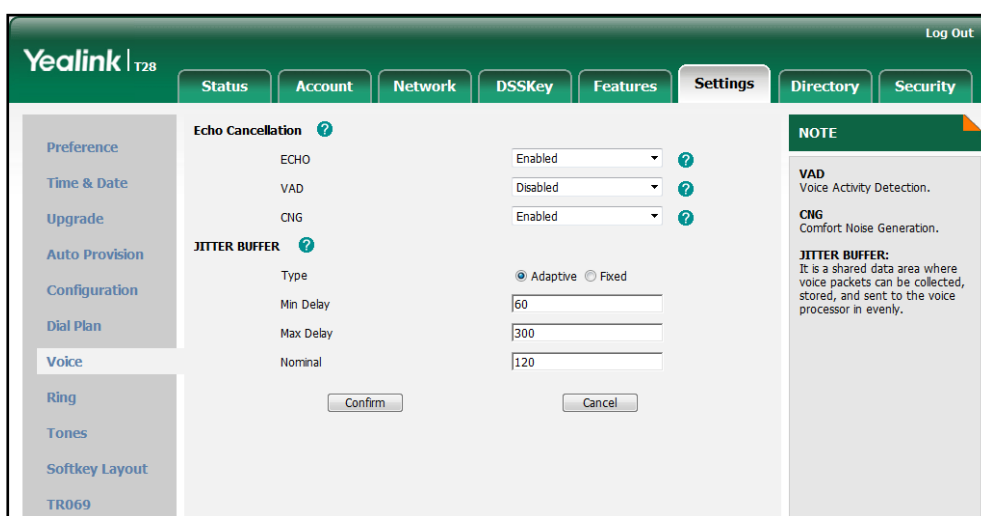

3. Click **Confirm** to accept the change.

## Voice Activity Detection

Voice Activity Detection (VAD) is used in speech processing to detect the presence or absence of human speech. When detecting period of “silence”, VAD replaces that silence efficiently with special packets that indicate silence is occurring. It can facilitate speech processing, and deactivate some processes during non-speech section of an audio session. VAD can avoid unnecessary coding or transmission of silence packets in VoIP applications, saving on computation and network bandwidth.

### Procedure

VAD can be configured using the configuration files or locally.

<b>Configuration File</b>	<y0000000000xx>.cfg	Configure VAD. For more information, refer to <a href="#">Voice Activity Detection</a> on page 359.
<b>Local</b>	Web User Interface	Configure VAD. <b>Navigate to:</b> http://<phoneIPAddress>/servlet?p=settings-voice&q=load

To configure VAD via web user interface:

1. Click on **Settings->Voice**.
2. Select the desired value from the pull-down list of **VAD**.

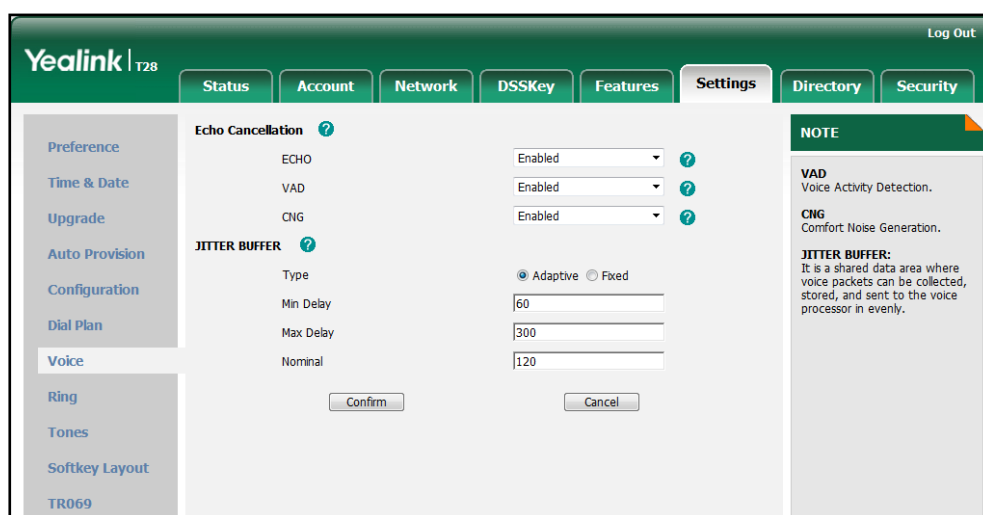

3. Click **Confirm** to accept the change.

## Comfort Noise Generation

Comfort Noise Generation (CNG) is used to generate background noise for voice communications during periods of silence in a conversation. It is part of the silence suppression or VAD handling for VoIP technology. CNG, in conjunction with VAD algorithms, quickly responds when periods of silence occur and inserts artificial noise until voice activity resumes. The insertion of artificial noise gives the illusion of a constant transmission stream, so that background sound is consistent throughout the call and the listener does not think the line has released. The purpose of VAD and CNG is to maintain an acceptable perceived QoS while simultaneously keeping transmission costs and bandwidth usage as low as possible.

### Procedure

CNG can be configured using the configuration files or locally.

<b>Configuration File</b>	<y0000000000xx>.cfg	Configure CNG. For more information, refer to <a href="#">Comfort Noise Generation on page 360</a> .
<b>Local</b>	Web User Interface	Configure CNG. <b>Navigate to:</b> http://<phoneIPAddress>/servlet?p=settings-voice&q=load

To configure CNG via web user interface:

1. Click on **Settings->Voice**.
2. Select the desired value from the pull-down list of **CNG**.

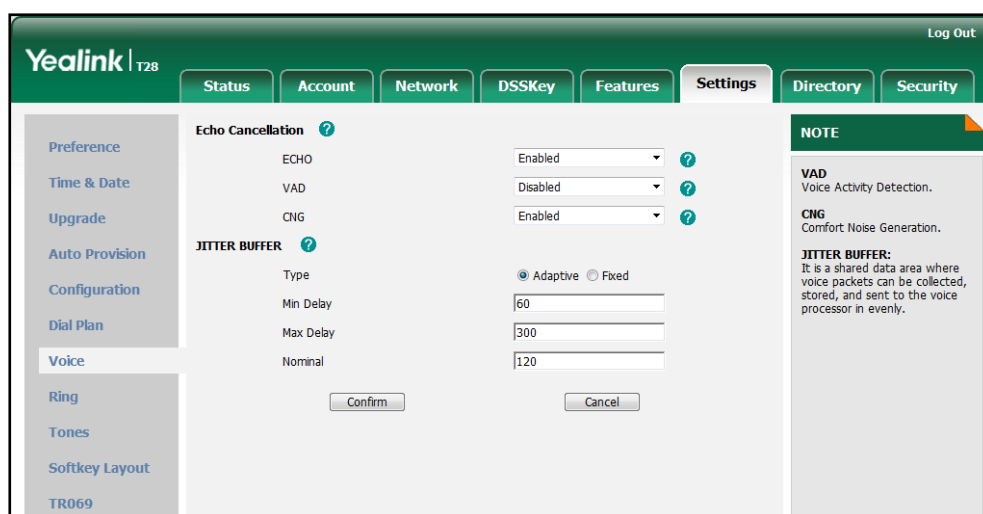

3. Click **Confirm** to accept the change.

## Jitter Buffer

Jitter buffer is a shared data area where voice packets can be collected, stored, and sent to the voice processor in even intervals. Jitter is a term indicating variations in packet arrival time, can occur because of network congestion, timing drift or route changes. The jitter buffer, located at the receiving end of the voice connection, intentionally delays the arriving packets so that the end user experiences a clear connection with very little sound distortion. IP phones support two types of jitter buffers: static and dynamic. A static jitter buffer adds the fixed delay to voice packets. You can configure the delay time for the static jitter buffer on IP phones. A dynamic jitter buffer is capable of adapting the changes in the network's delay. The range of the delay time for the dynamic jitter buffer added to packets can be also configured on IP phones.

### Procedure

Jitter buffer can be configured using the configuration files or locally.

<b>Configuration File</b>	<y0000000000xx>.cfg	Configure the mode of jitter buffer and the delay time for jitter buffer.  For more information, refer to <a href="#">Jitter Buffer</a> on page 360.
<b>Local</b>	Web User Interface	Configure the mode of jitter buffer and the delay time for jitter buffer.  <b>Navigate to:</b>  http://<phoneIPAddress>/servlet?p=settings-voice&q=load

**To configure Jitter Buffer via web user interface:**

1. Click on **Settings->Voice**.
2. Mark the desired radio box in the **Type** field.
3. Enter the minimum delay time for adaptive jitter buffer in the **Min Delay** field.
4. Enter the maximum delay time for adaptive jitter buffer in the **Max Delay** field.

- Enter the fixed delay time for fixed jitter buffer in the **Nominal** field.

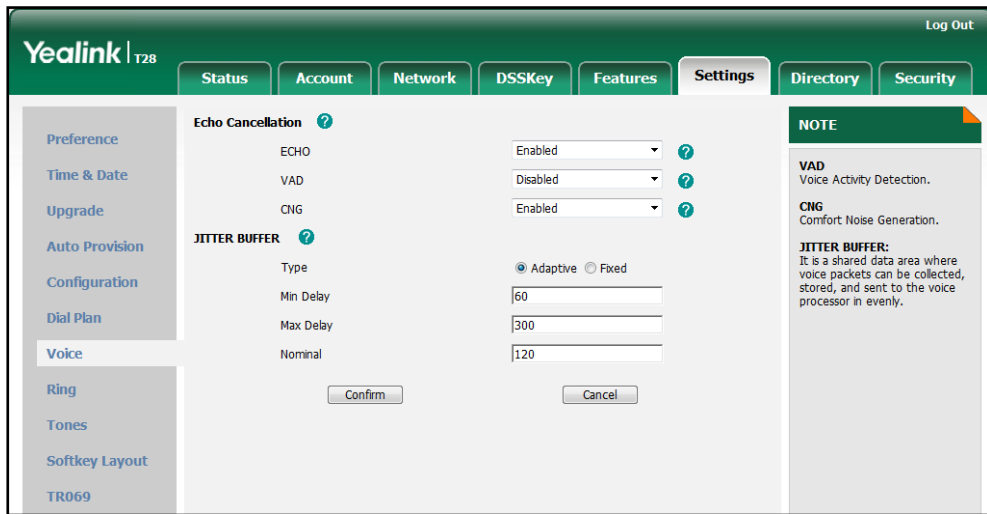

- Click **Confirm** to accept the change.





# Configuring Security Features

This chapter provides information for making configuration changes for the following security-related features:

- [Transport Layer Security](#)
- [Secure Real-Time Transport Protocol](#)
- [Encrypting Configuration Files](#)

## Note

To use these features correctly, we recommend that IP phones CANNOT be downgraded to the earlier firmware version.

## Transport Layer Security

TLS is a commonly-used protocol for providing communications privacy and managing the security of message transmission, allowing IP phones to communicate with other remote parties and connect to the HTTPS URL for provisioning in a way that is designed to prevent eavesdropping and tampering.

TLS protocol is composed of two layers: TLS Record Protocol and TLS Handshake Protocol. The TLS Record Protocol completes the actual data transmission and ensures the integrity and privacy of the data. The TLS Handshake Protocol allows the server and client to authenticate each other and negotiate an encryption algorithm and cryptographic keys before data is exchanged.

The TLS protocol uses asymmetric encryption for authentication of key exchange, and symmetric encryption for confidentiality, and message authentication codes for integrity.

- **Symmetric encryption:** For symmetric encryption, the encryption key and the corresponding decryption key can be told by each other. In most cases, the encryption key is the same as the decryption key.
- **Asymmetric encryption:** For asymmetric encryption, each user has a pair of cryptographic keys – a public encryption key and a private decryption key. The information encrypted by the public key can only be decrypted by the corresponding private key and vice versa. Usually, the receiver keeps its private key. The public key is known by the sender, so the sender sends the information encrypted by the known public key, and then the receiver uses the private key to decrypt it.

IP phones support TLS version 1.0. A cipher suite is a named combination of authentication, encryption, and message authentication code (MAC) algorithms used to negotiate the security settings for a network connection using the TLS/SSL network

protocol. IP phones supports the following cipher suites for TLS 1.0:

- DHE-RSA-AES256-SHA
- DHE-DSS-AES256-SHA
- AES256-SHA
- EDH-RSA-DES-CBC3-SHA
- EDH-DSS-DES-CBC3-SHA
- DES-CBC3-SHA
- DHE-RSA-AES128-SHA
- DHE-DSS-AES128-SHA
- AES128-SHA
- IDEA-CBC-SHA
- DHE-DSS-RC4-SHA
- RC4-SHA
- RC4-MD5
- EXP1024-DHE-DSS-DES-CBC-SHA
- EXP1024-DES-CBC-SHA
- EDH-RSA-DES-CBC-SHA
- EDH-DSS-DES-CBC-SHA
- DES-CBC-SHA
- EXP1024-DHE-DSS-RC4-SHA
- EXP1024-RC4-SHA
- EXP1024-RC4-MD5
- EXP-EDH-RSA-DES-CBC-SHA
- EXP-EDH-DSS-DES-CBC-SHA
- EXP-DES-CBC-SHA
- EXP-RC4-MD5

The following figure illustrates the TLS messages exchanged between the IP phone and TLS server to establish an encrypted communication channel:

The image shows a Wireshark network capture of a TLS handshake. The main pane displays a list of packets with the following data:

No.	Time	Source	Destination	Protocol	Info
1	0.000000	192.168.3.86	192.168.0.230	SSLV3	Client Hello
2	0.021345	192.168.0.230	192.168.3.86	SSLV3	Server Hello, Certificate, server key Exchange, server Hello Done
3	0.954947	192.168.3.86	192.168.0.230	SSLV3	Client Key Exchange, Change Cipher Spec, Encrypted Handshake Message
4	0.970099	192.168.0.230	192.168.3.86	SSLV3	Change Cipher Spec, Encrypted Handshake Message
5	1.012295	192.168.3.86	192.168.0.230	SSLV3	Application Data, Application Data
6	1.013562	192.168.0.230	192.168.3.86	SSLV3	Application Data
7	1.013667	192.168.0.230	192.168.3.86	SSLV3	Application Data

The packet details pane for frame 13 shows:

- Frame 13: 652 bytes on wire (5216 bits), 652 bytes captured (5216 bits)
- Ethernet II, Src: Vmware\_72:c9:2e (00:0c:29:72:c9:2e), Dst: Xiamenye\_11:12:b7 (00:15:65:11:12:b7)
- Internet Protocol, Src: 192.168.0.230 (192.168.0.230), Dst: 192.168.3.86 (192.168.3.86)
- Transmission Control Protocol, Src Port: https (443), Dst Port: nmserver (2244), Seq: 1482, Ack: 437, Len: 586
- Secure Socket Layer

**Step1:** IP phone sends “Client Hello” message proposing SSL options.

**Step2:** Server responds with “Server Hello” message selecting the SSL options, sends its public key information in “Server Key Exchange” message and concludes its part of the negotiation with “Server Hello Done” message.

**Step3:** IP phone sends session key information (encrypted with server’s public key) in the “Client Key Exchange” message.

**Step4:** Server sends “Change Cipher Spec” message to activate the negotiated options for all future messages it will send.

IP phones can encrypt SIP with TLS, which is called SIPS. When TLS is enabled for an account, the SIP message of this account will be encrypted, and a lock icon appears on the LCD screen after the successful TLS negotiation.

## Certificates

The IP phone can serve as a TLS client or a TLS server. The TLS requires the following security certificates to perform the TLS handshake:

- Trusted Certificate:** When the IP phone requests a TLS connection with a server, the IP phone should verify the certificate sent by the server to decide whether it is trusted based on the trusted certificates list. The IP phone has 30 built-in trusted certificates. You can upload 10 custom certificates at most. The format of the trusted certificate files must be \*.pem, \*.cer, \*.crt and \*.der.
- Server Certificate:** When the other clients request a TLS connection with the IP phone, the IP phone sends the server certificate to the clients for authentication. The IP phone has one built-in server certificate. You can only upload one server certificate to the IP phone. The old server certificate will be overridden by the new one. The format of the server certificate files must be \*.pem and \*.cer.

Whether IP phone authenticates the server certificate can be specified based on the trusted certificates list. The trusted certificates list and the server certificates list contain the default and custom certificates. You can specify the type of certificates the IP phone accepts: default certificates, custom certificates, or all certificates. Common Name Validation feature enables the IP phone to mandatorily validate the common name of the certificate sent by the connecting server.

## Procedure

Configuration changes can be performed using the configuration files or locally.

<p><b>Configuration File</b></p>	<p>&lt;MAC&gt;.cfg</p>	<p>Configure TLS on a per-line basis. For more information, refer to <a href="#">TLS on page 362</a>.</p>
	<p>&lt;y0000000000xx&gt;.cfg</p>	<p>Configure trusted certificates feature. Configure server certificates feature. For more information, refer to <a href="#">TLS on page 362</a>. Upload the trusted certificates. Upload the server certificates. For more information, refer to <a href="#">Uploading Certificates on page 364</a>.</p>
<p><b>Local</b></p>	<p>Web User Interface</p>	<p>Configure TLS on a per-line basis. <b>Navigate to:</b> http://&lt;phoneIPAddress&gt;/servlet?p=account-register&amp;q=load&amp;acc=0 Configure trusted certificates feature. Upload the trusted certificates. <b>Navigate to:</b> http://&lt;phoneIPAddress&gt;/servlet?p=trusted-cert&amp;q=load Configure server certificates feature. Upload the server certificates. <b>Navigate to:</b> http://&lt;phoneIPAddress&gt;/servlet?p=server-cert&amp;q=load</p>

To configure TLS on a per-line basis via web user interface:

1. Click on **Account->Register**.
2. Select the desired account from the pull-down list of **Account**.
3. Select **TLS** from the pull-down list of **Transport**.

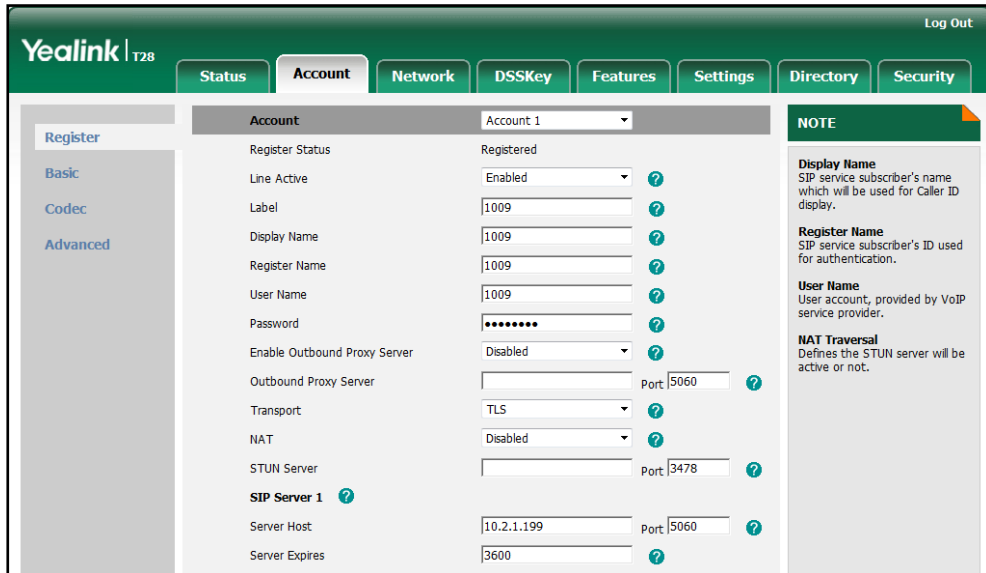

4. Click **Confirm** to accept the change.

To configure the trusted certificates via web user interface:

1. Click on **Security->Trusted Certificates**.
2. Select the desired values from the pull-down lists of **Only Accept Trusted Certificates**, **Common Name Validation** and **CA Certificates**.

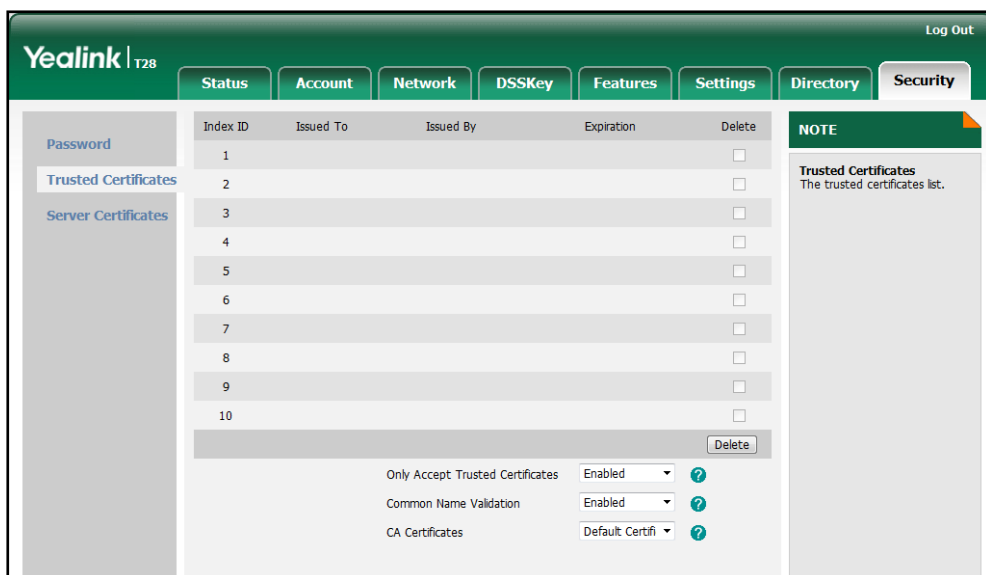

3. Click **Confirm** to accept the change.

**To upload a trusted certificate via web user interface:**

1. Click on **Security->Trusted Certificates**.
2. Click **Browse** to select the certificate (\*.pem, \*.crt, \*.cer or \*.der) from your local system.

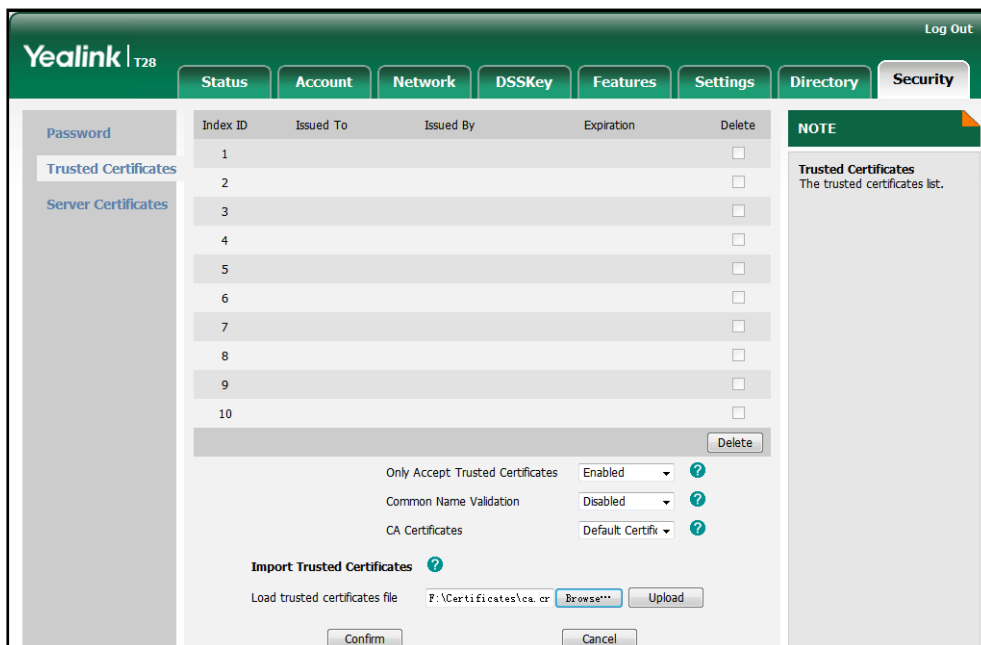

3. Click **Upload** to upload the certificate.

**To configure the server certificates via web user interface:**

1. Click on **Security->Server Certificates**.
2. Select the desired value from the pull-down list of **Device Certificates**.

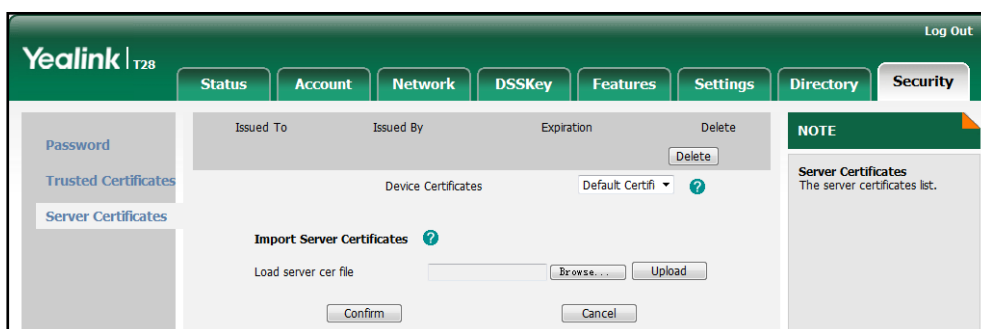

3. Click **Confirm** to accept the change.

**To upload a server certificate via web user interface:**

1. Click on **Security->Server Certificates**.

- Click **Browse** to select the certificate (\*.pem and \*.cer) from your local system.

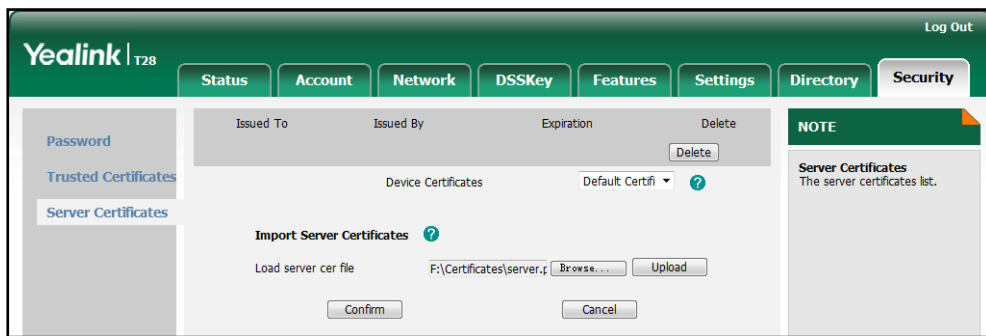

- Click **Upload** to upload the certificate.

A dialog box pops up to prompt "Success: The Server Certificate has been loaded! Rebooting, please wait...".

## Secure Real-Time Transport Protocol

Secure Real-Time Transport Protocol (SRTP) encrypts the RTP streams during VoIP phone calls to avoid interception and eavesdropping. The parties participating in the call must enable SRTP feature simultaneously. When this feature is enabled on both phones, the type encryption algorithm utilized for the session is negotiated between the IP phones. This negotiation process is compliant with RFC 4568.

When a user places a call on the enabled SRTP phone, the IP phone sends an INVITE message with the RTP encryption algorithm to the destination phone.

Example of the RTP encryption algorithm carried in the SDP of the INVITE message:

```
m=audio 11780 RTP/SAVP 0 8 18 9 101
a=crypto:1 AES_CM_128_HMAC_SHA1_80
inline:NzFINTUwZDK2OGVIOTc3YzNkYTkWZWWkMTM1YWFj
a=crypto:2 AES_CM_128_HMAC_SHA1_32
inline:NzkyM2FjNzQ2ZDgxYjg0MzQwMGVmMGUxMzdmNWFm
a=crypto:3 F8_128_HMAC_SHA1_80 inline:NDIiMWwzZGE1ZTAwZjA5ZGFhNjQ5YmEANTMzYzA0
a=rtpmap:0 PCMU/8000
a=rtpmap:8 PCMA/8000
a=rtpmap:18 G729/8000
a=fmtp:18 annexb=no
a=rtpmap:9 G722/8000
a=fmtp:101 0-15
a=rtpmap:101 telephone-event/8000
a=ptime:20
a=sendrecv
```

The callee receives the INVITE message with the RTP encryption algorithm, and then answers the call by responding with a 200 OK message which carries the negotiated RTP encryption algorithm.

Example of the RTP encryption algorithm carried in the SDP of the 200 OK message:

```
m=audio 11780 RTP/SAVP 0 101
a=rtpmap:0 PCMU/8000
a=rtpmap:101 telephone-event/8000
a=crypto:1 AES_CM_128_HMAC_SHA1_80
inline:NGY4OGViMDYzZjQzYTNiOTNkOWRiYzRiMjM0Yzcz
a=sendrecv
a=ptime:20
a=fmtp:101 0-15
```

SRTP is configurable on a per-line basis. When SRTP is enabled on both IP phones, RTP streams will be encrypted, and a lock icon appears on the LCD screen of each IP phone after successful negotiation.

**Note**

If you enable SRTP, then you should also enable TLS. This ensures the security of SRTP encryption. For more information on TLS, refer to [Transport Layer Security](#) on page 205.

**Procedure**

SRTP can be configured using the configuration files or locally.

<b>Configuration File</b>	<MAC>.cfg	Configure SRTP feature on a per-line basis. For more information, refer to <a href="#">SRTP</a> on page 365.
<b>Local</b>	Web User Interface	Configure SRTP feature on a per-line basis. <b>Navigate to:</b> http://<phoneIPAddress>/servlet ?p=account-adv&q=load&acc=0

**To configure SRTP feature via web user interface:**

1. Click on **Account**.
2. Select the desired account from the pull-down list of **Account**.
3. Click on **Advanced**.



- Select the desired value from the pull-down list of **RTP Encryption (SRTP)**.

The screenshot shows the Yealink T28 web interface with the 'Account' tab selected. The 'RTP Encryption (SRTP)' setting is set to 'Compulsory'. Other settings include 'Keep Alive Type' (Default), 'Keep Alive Interval(Seconds)' (30), 'Local SIP Port' (5062), 'RPort' (Disabled), 'SIP Session Timer T1 (0.5~10s)' (0.5), 'SIP Session Timer T2 (2~40s)' (4), 'SIP Session Timer T4 (2.5~60s)' (5), 'Subscribe Period(Seconds)' (1800), 'DTMF Type' (RFC2833), 'DTMF Info Type' (DTMF-Relay), 'DTMF Payload Type(96~127)' (101), 'Retransmission' (Disabled), 'Subscribe for MWI' (Disabled), 'MWI Subscription Period(Seconds)' (3600), 'Subscribe MWI To Voice Mail' (Disabled), 'Voice Mail' (empty), 'Caller ID Source' (FROM), 'Session Timer' (Disabled), 'Session Expires(30~7200s)' (1800), 'Session Refresher' (UAC), 'Send user=phone' (Disabled), and 'PTime(ms)' (20). A 'NOTE' box on the right states: 'Advanced: The Advanced parameters for administrator.'

- Click **Confirm** to accept the change.

## Encrypting Configuration Files

Encrypted configuration files can be downloaded from the provisioning server to protect against unauthorized access and tampering of sensitive information (e.g., login passwords, registration information). Configuration files can be encrypted using a command line tool. The encryption algorithm is AES 128. From a Microsoft Windows command line, you can use Yealink-supplied encryption tool "EncryptUtilityWindows.exe" to encrypt the <y0000000000xx>.cfg and <MAC>.cfg files respectively.

### Note

Yealink also supplies an encryption tool (EncryptUtilityLinux.exe) for Linux platforms if applicable.

Configuration files can also be encrypted using Yealink Configuration Conversion Tool. For more information, refer to *Yealink Configuration Conversion Tool User Guide*.

The filename extension of the encrypted configuration files must be .cfg. The Common AES key is used to encrypt and decrypt the <y0000000000xx>.cfg file and the MAC-Oriented AES key is used to encrypt and decrypt the <MAC>.cfg file. AES keys must be 16 characters. The AES key must be configured on IP phones for decrypting

before provisioning.

## Procedure to Encrypt Configuration Files

To encrypt the <y0000000000xx>.cfg file:

1. Place the "EncryptUtilityWindows.exe" tool and <y0000000000xx>.cfg file to the same directory (e.g., D:\).
2. Open a command line window application (e.g., DOS window).
3. Enter the following command, and then press the <Enter> key.

```
D:EncryptUtilityWindows.exe 123456789abcdef0 e F:\y000000000000.cfg
D:\y0000000000000000.cfg

#D:EncryptUtilityWindows.exe <a 16-character secret key> e <a new
directory and file name of the encrypted configuration file> <the
directory and file name of the original configuration file>
```

4. Place the encrypted configuration file to the provisioning server.

The way for encrypting the <MAC>.cfg file is the same as the <y0000000000xx>.cfg file. After encrypting the configuration files, you need to configure the AES keys on IP phones.

### Procedure

AES keys can be configured using the configuration files or locally.

<b>Configuration File</b>	<y0000000000xx>.cfg	Configure the AES keys. For more information, refer to <a href="#">Configuring AES Keys</a> on page 365.
<b>Local</b>	Web User Interface	Configure the AES keys. <b>Navigate to:</b> http://<phoneIPAddress>/servlet?<p=settings-autop&q=load

To configure the AES keys via web user interface:

1. Click on **Settings->Auto Provision**.

- Enter the desired values in the **Common AES Key** and **MAC-Oriented AES Key** fields.

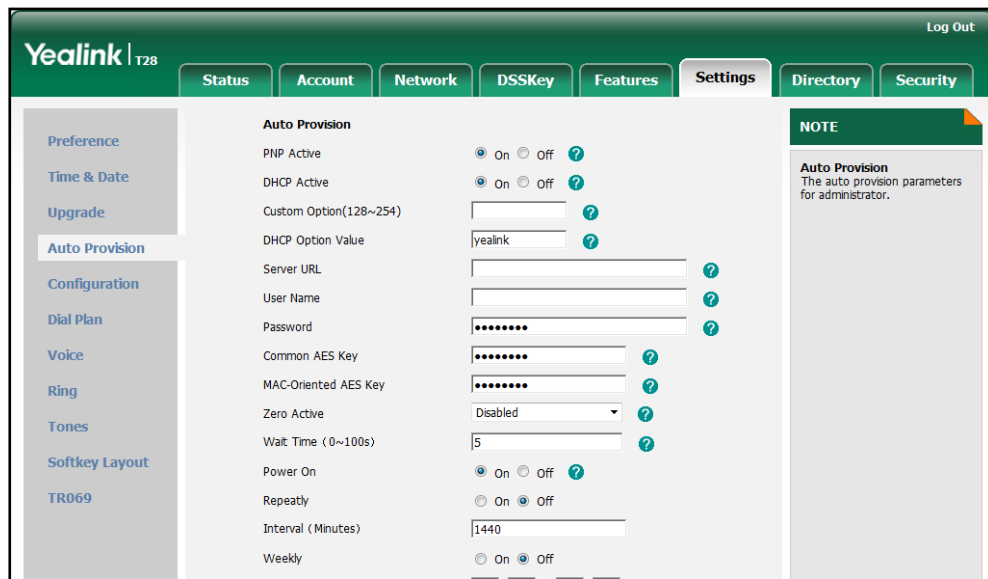

- Click **Confirm** to accept the change.



## Upgrading Firmware

This chapter provides information about upgrading the IP phone firmware. Two methods of firmware upgrade:

- Manually from the local system.
- Automatically, from the provisioning server.

The following table lists the associated firmware name for each IP phone model (X is replaced by the actual firmware version).

IP Phone Model	Associated Firmware Name
SIP-T28P	2.x.x.x.rom
SIP-T26P	6.x.x.x.rom
SIP-T22P	7.x.x.x.rom
SIP-T21P	34.x.x.x.rom
SIP-T20P	9.x.x.x.rom
SIP-T19P	31.x.x.x.rom

### Note

You can download the latest firmware online:

<http://www.yealink.com/DocumentDownload.aspx?CatId=142&flag=142>.

### Upgrade via Web User Interface

To manually upgrade firmware via web user interface, you need to store firmware to your local system in advance.

**To upgrade firmware manually via web user interface:**

1. Click on **Settings->Upgrade**.
2. Click **Browse**.
3. Select firmware from the local system.
4. Click **Upgrade**.

A dialog box pops up to prompt “Firmware of the SIP Phone will be updated. It will take 5 minutes to complete. Please don't power off!”.

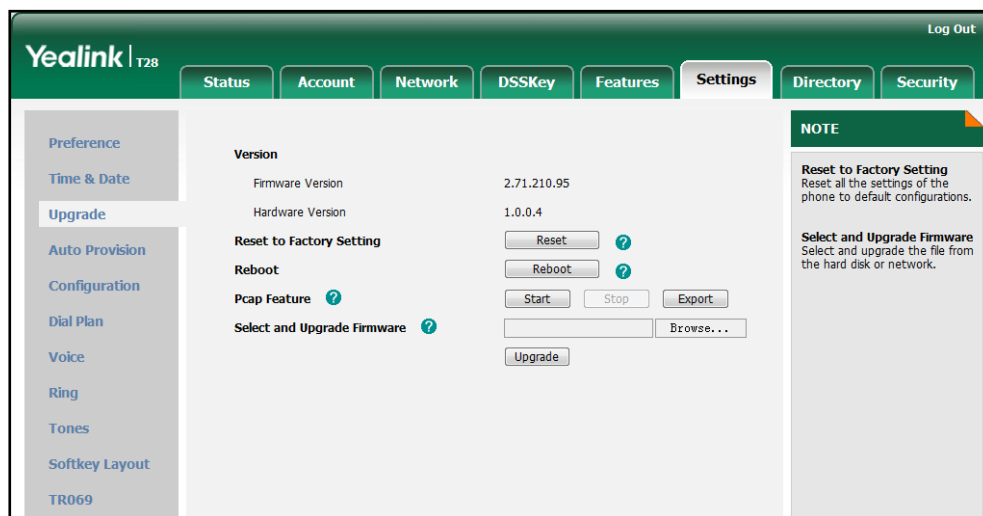

5. Click **OK** to confirm the upgrading.

**Note**

Do not unplug the network and power cables when the IP phone is upgrading the firmware.

Do not close the browser when the IP phone is upgrading the firmware via web user interface.

### Upgrade Firmware from the Provisioning Server

IP phones support using the FTP, TFTP, HTTP, and HTTPS protocols to download the configuration files and firmware from the provisioning server, and then upgrade firmware automatically.

IP phones can download firmware stored on the provisioning server in one of two ways:

- Check for both configuration files and firmware stored on the provisioning server during startup.
- Automatically check for configuration files and firmware at a fixed interval or specific time.

Method of checking for configuration files and firmware is configurable.

### Procedure

Configuration changes can be performed using the configuration files or locally.

<p><b>Configuration File</b></p>	<p>&lt;y0000000000xx&gt;.cfg</p>	<p>Configure the way for the IP phone to check for configuration files.</p> <p>Specify the access URL of the</p>
----------------------------------	----------------------------------	--

		<p>firmware.</p> <p>For more information, refer to <a href="#">Upgrading Firmware</a> on page 366.</p>
Local	Web User Interface	<p>Configure the way for the IP phone to check for configuration files.</p> <p><b>Navigate to:</b></p> <p>http://&lt;phoneIPAddress&gt;/servlet?&lt;p=settings-autop&amp;q=load</p>

To configure the way for the IP phone to check for new configuration files via web user interface:

1. Click on **Settings->Auto Provision**.
2. Make the desired change.

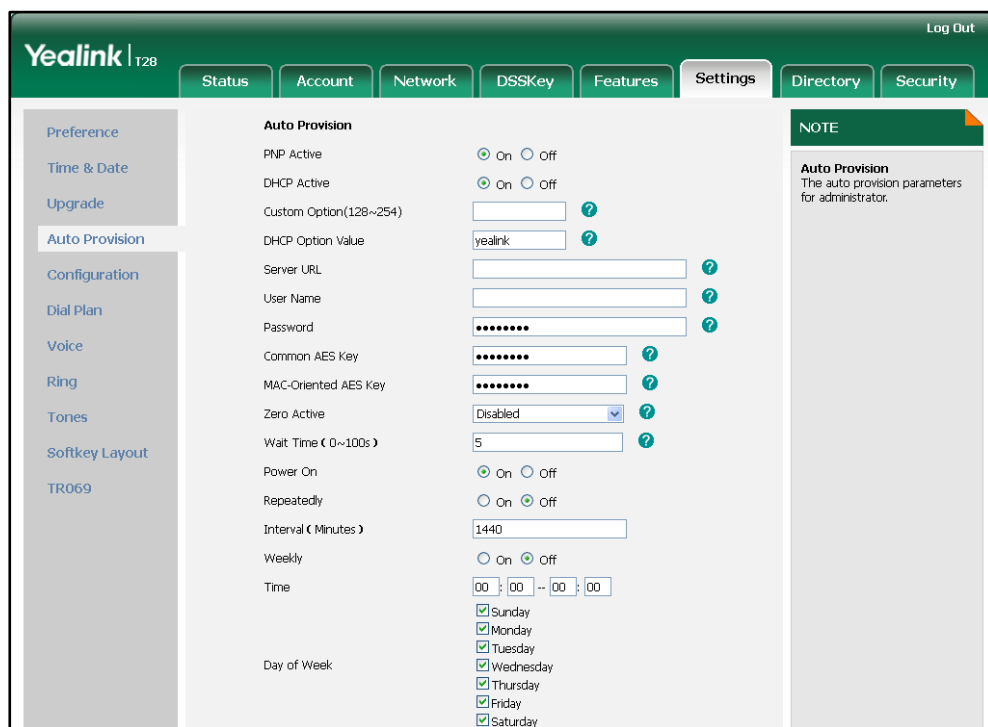

3. Click **Confirm** to accept the change.

When the “Power On” is set to **On**, the IP phone will check for both firmware and configuration files stored on the provisioning server during startup.





## Resource Files

---

When configuring particular features, you may need to upload resource files (e.g., local contact directory, remote phone book) to IP phones. The resources files can be local contact directory, remote phone book and so on. Ask Yealink field application engineer for resource file templates. If the resource file is to be used for all IP phones of the same model, the resource file access URL is best specified in the <y0000000000xx>.cfg file. However, if you want to specify the desired phone to use the resource file, the resource file access URL should be specified in the <MAC>.cfg file.

This chapter provides the detailed information on how to customize the following resource files and specify the access URL:

- [Replace Rule Template](#)
- [Dial-now Template](#)
- [Softkey Layout Template](#)
- [Local Contact File](#)
- [Remote XML Phone Book](#)
- [Specifying the Access URL of Resource Files](#)

## Replace Rule Template

The replace rule template helps with the creation of multiple replace rules. After setup, place the replace rule template to the provisioning server and specify the access URL in the configuration files.

When editing a replace rule template, learn the following:

- <DialRule> indicates the start of a template and </DialRule> indicates the end of a template.
- Create replace rules between <DialRule> and </DialRule>.
- When specifying the desired line(s) to apply the replace rule, the valid values are 0 and line ID. The digit 0 stands for all lines. Multiple line IDs are separated by comma.
- At most 100 replace rules can be added to the IP phone.
- The expression syntax in the replace rule template is the same as introduced in the section [Creating Dial Plan](#) on page 32.

## Procedure

Use the following procedures to customize a replace rule template.

### To customize a replace rule template:

1. Open the template file using an ASCII editor.
2. Add the following string to the template, each starting on a separate line:

```
<Data Prefix="" Replace="" LineID=""/>
```

### Where:

Prefix="" specifies the numbers to be replaced.

Replace="" specifies the alternate string instead of what the user enters.

LineID="" specifies the desired line(s) for this rule. When you leave it blank or enter 0, this replace rule will apply to all lines.

3. Specify the values within double quotes.
4. Place this file to the provisioning server.

The following is an example of a replace rule template:

```
<DialRule>
  <Data Prefix="1" Replace="05928665234" LineID=""/>
  <Data Prefix="2(xx)" Replace="002$1" LineID="0"/>
  <Data Prefix="5([6-9]) (.)" Replace="3$2" LineID="1,2,3"/>
  <Data Prefix="0(.)" Replace="9$1" LineID="2"/>
  <Data Prefix="1009" Replace="05921009" LineID="1"/>
</DialRule>
```

## Dial-now Template

The dial-now template helps with the creation of multiple dial-now rules. After setup, place the dial-now template to the provisioning server and specify the access URL in the configuration files.

When editing a dial-now template, learn the following:

- <DialNow> indicates the start of a template and </DialNow> indicates the end of a template.
- Create dial-now rules between <DialNow> and </DialNow>.
- When specifying the desired line(s) for the dial-now rule, the valid values are 0 and line ID. 0 stands for all lines. Multiple line IDs are separated by comma.
- At most 100 rules can be added to the IP phone.
- The expression syntax in the dial-now rule template is the same as introduced in the section [Creating Dial Plan](#) on page 32.

## Procedure

Use the following procedures to customize a dial-now template.

### To customize a dial-now template:

1. Open the template file using an ASCII editor.
2. Add the following string to the template, each starting on a separate line:

```
<Data DialNowRule="" LineID=""/>
```

### Where:

DialNowRule="" specifies the dial-now rule.

LineID="" specifies the desired line(s) for this rule. When you leave it blank or enter 0, this dial-now rule will apply to all lines.

3. Specify the values within double quotes.
4. Place this file to the provisioning server.

The following is an example of a dial-now template:

```
<DialNow>
  <Data DialNowRule="1234" LineID="1"/>
  <Data DialNowRule="52[0-6]" LineID="1"/>
  <Data DialNowRule="xxxxxx" LineID=""/>
</DialNow>
```

## Softkey Layout Template

The softkey layout template allows assigning different soft key layouts to different call states. The call states include CallFailed, CallIn, Connecting, Dialing, RingBack and Talking. After setup, place the templates to the provisioning server and specify the access URL in the configuration files.

When editing a softkey layout template, learn the following:

- <Call States> indicates the start of a template and </Call States> indicates the end of a template. For example, <CallFailed> </CallFailed>.
- <Disable> indicates the start of the disabled soft key list and </Disable> indicates the end of the soft key list, the disabled soft keys are not displayed on the LCD screen.
- Create disabled soft keys between <Disable> and </Disable>.
- <Enable> indicates the start of the enabled soft key list and </Enable> indicates the end of the soft key list, the enabled soft keys are displayed on the LCD screen.
- Create enabled soft keys between <Enable> and </Enable>.
- <Default> indicates the start of the default soft key list and </Default> indicates

the end of the default soft key list, the default soft keys are displayed on the LCD screen by default.

## Procedure

Use the following procedures to customize a softkey layout template.

### To customize a softkey layout template:

1. Open the template file using an ASCII editor.
2. For each soft key that you want to enable, add the following string to the file. Each starts on a separate line:

```
<Key Type=""/>
```

### Where:

Key Type="" specifies the enabled soft key (This value cannot be blank).

For each disabled soft key and each default soft key that you want to add, add the same string introduced above.

3. Specify the values within double quotes.
4. Place this file to the provisioning server.

The following is an example of the CallFailed template:

```
<CallFailed>
  <Disable>
    <Key Type="Empty"/>
    <Key Type="Switch"/>
    <Key Type="Cancel"/>
  </Disable>
  <Enable>
    <Key Type="NewCall"/>
    <Key Type="Empty"/>
    <Key Type="Empty"/>
    <Key Type="Empty"/>
  </Enable>
  <Default>
    <Key Type="NewCall"/>
    <Key Type="Empty"/>
    <Key Type="Empty"/>
    <Key Type="Empty"/>
  </Default>
</CallFailed>
```

## Local Contact File

You can add contacts one by one on the IP phone directly. You can also add multiple contacts at a time and/or share contacts between IP phones using the local contact template file. After setup, place the template file to the provisioning server and specify the access URL of the template file in the configuration files.

When editing a local contact template file, learn the following:

- `<root_contact>` indicates the start of a contact list and `</root_contact>` indicates the end of a contact list.
- `<root_group>` indicates the start of a group list and `</root_group>` indicates the end of a group list.
- When specifying a ring tone for the contact or the group, the format of the value must be `Auto`, `Resource:RingN.wav` (system ringtone, integer N ranges from 1 to 8) or `Custom:Name.wav` (customized ringtone).
- When specifying the desired line for the contact, the valid values are 0 and line ID, 0 stands for the first available account. Multiple line IDs are separated by comma.

### Procedure

Use the following procedures to customize a local contact template file.

#### To customize a local contact file:

1. Open the template file using an ASCII editor.
2. For each group that you want to add, add the following string to the file. Each starts on a separate line:

```
<group display_name="" ring=""/>
```

#### Where:

`display_name=""` specifies the name of the group.

`ring=""` specifies the desired ring tone for this group.

3. For each contact that you want to add, add the following string to the file. Each starts on a separate line:

```
<contact display_name="" office_number="" mobile_number="" other_number=""
line="" ring="" group_id_name=""/>
```

#### Where:

`display_name=""` specifies the name of the contact (This value cannot be blank or duplicated).

`office_number=""` specifies the office number of the contact.

`mobile_number=""` specifies the mobile number of the contact.

`other_number=""` specifies the other number of the contact.

line="" specifies the line you want to add this contact to.

ring="" specifies the ring tone for this contact.

group\_id\_name="" specifies the existing group you want to add the contact to.

4. Specify the values within double quotes.
5. Place this file to the provisioning server.

The following is an example of a local contact file:

```
<root_group>
  <group display_name="Friend" ring=""/>
  <group display_name="Family" ring="Resource:Ring1.wav"/>
</root_group>
<root_contact>
  <contact display_name="John" office_number="1001"
  mobile_number="12345678910" other_number="" line="0" ring="Auto"
  group_id_name="All Contacts"/>
  <contact display_name="Alice" office_number="1002" mobile_number=""
  other_number="" line="1,2" ring="Resource:Ring2.wav"
  group_id_name="Friend"/>
</root_contact>
```

## Remote XML Phone Book

IP phones can access 5 remote phone books. You can customize the remote XML phone book for IP phones as required. Before specifying the access URL of the remote phone book in the configuration files, you need to create a remote XML phone book and then place it to the provisioning server.

When creating an XML phone book, learn the following:

- <YealinkIPPhoneDirectory> indicates the start of a phone book and </YealinkIPPhoneDirectory> indicates the end of a phone book.
- <DirectoryEntry> indicates the start of a contact and </DirectoryEntry> indicates the end of a contact.

### Procedure

Use the following procedures to customize an XML phone book.

#### Customizing an XML phone book:

1. Open the template file using an ASCII editor.

- For each contact that you want to add, add the following strings to the phone book. Each starts on a separate line:

```
<Name>Mary</Name>
<Telephone>1001</Telephone>
```

**Where:**

Specify the contact name between <Name> and </Name>.

Specify the contact number between <Telephone> and </Telephone>.

- Specify the values within double quotes.
- Place this file to the provisioning server.

The following is an example of an XML phone book:

```
<YealinkIPPhoneDirectory>
  <DirectoryEntry>
    <Name>Jack</Name>
    <Telephone>1003</Telephone>
  </DirectoryEntry>
  <DirectoryEntry>
    <Name>John</Name>
    <Telephone>1004</Telephone>
  </DirectoryEntry>
  <DirectoryEntry>
    <Name>Marry</Name>
    <Telephone>1005</Telephone>
  </DirectoryEntry>
</YealinkIPPhoneDirectory>
```

**Note**

Yealink supplies a phonebook generation tool to generate a remote XML phone book. For more information, refer to *Yealink Phonebook Generation Tool User Guide*.

## Specifying the Access URL of Resource Files

Access URL of the resource file can be configured in the configuration files:

<p><b>Configuration File</b></p>	<p>&lt;y0000000000xx&gt;.cfg</p>	<p>Configure the access URL of the replace rule template. For more information, refer to <a href="#">Access URL of Replace Rule Template</a> on page 371.</p>
----------------------------------	----------------------------------	---

<b>Configuration File</b>	<y0000000000xx>.cfg	Configure the access URL of the dial-now rule template. For more information, refer to <a href="#">Access URL of Dial-now Template</a> on page 371.
<b>Configuration File</b>	<y0000000000xx>.cfg	Configure the access URL of the softkey layout template. For more information, refer to <a href="#">Access URL of Softkey Layout Template</a> on page 371.
<b>Configuration File</b>	<y0000000000xx>.cfg	Configure the access URL of the local contact file. For more information, refer to <a href="#">Access URL of Local Contact File</a> on page 374.
<b>Configuration File</b>	<y0000000000xx>.cfg	Configure the access URL of the remote XML phone book. For more information, refer to <a href="#">Access URL of Remote XML Phone Book</a> on page 374.



# Troubleshooting

---

This chapter provides an administrator with general information for troubleshooting some common problems that he (or she) may encounter while using IP phones.

## Troubleshooting Methods

IP phones can provide feedback in a variety of forms such as log files, packets, status indicators and so on, which can help an administrator more easily find the system problem and fix it.

The following are helpful for better understanding and resolving the working status of the IP phone.

- [Viewing Log Files](#)
- [Capturing Packets](#)
- [Enabling Watch Dog Feature](#)
- [Getting Information from Status Indicators](#)
- [Analyzing Configuration File](#)

## Viewing Log Files

If your IP phone encounters some problems, commonly the log files are used. You can export the log files to a syslog server or the local system. You can also specify the system log level. The default system log level is 3 (Changes to this parameter via web user interface require a reboot).

In the configuration files, you can use the following parameters to configure log settings:

- **syslog.server** -- Specify the IP address of the syslog server to which the log will be exported.
- **syslog.log\_level** -- Specify the system log level.

For more information on the log setting parameters, refer to [Log Settings](#) on page 375.

**To configure the level of the system log via web user interface:**

1. Click on **Settings->Configuration**.

2. Select the desired level from the pull-down list of **System Log Level**.

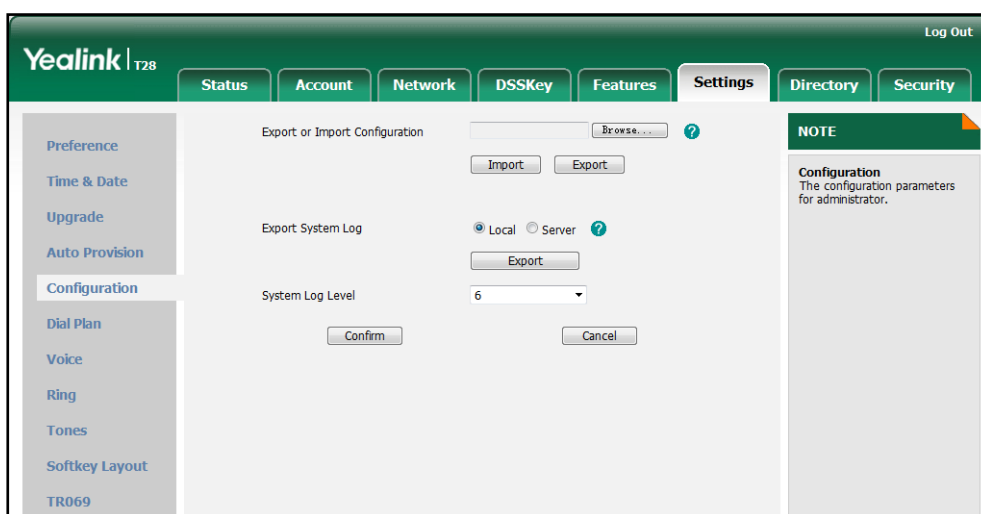

3. Click **Confirm** to accept the change.  
A dialog box pops up to prompt "Do you want to restart your machine?". The configuration will take effect after reboot.
4. Click **OK** to reboot the IP phone.  
After rebooting the phone, the system log level is set as 6, the debug level.

**Note**

The system level 6 log will display the password-dial number, which may lead to information disclosure.

**To configure the phone to export the system log to a syslog server via web user interface:**

1. Click on **Settings->Configuration**.
2. Mark the **Server** radio box in the **Export System Log** field.
3. Enter the IP address or domain name of the syslog server in the **Server Name** field.

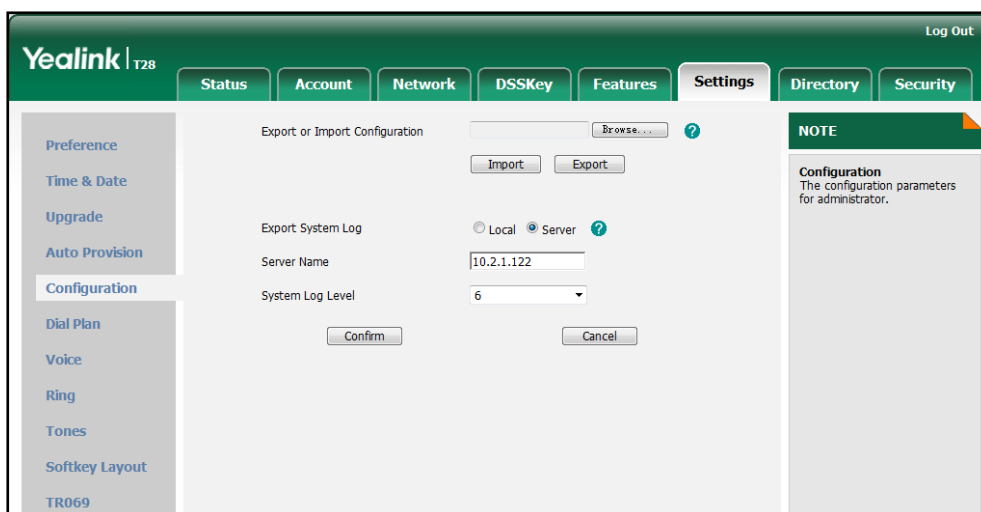

4. Click **Confirm** to accept the change.  
A dialog box pops up to prompt “Do you want to restart your machine?”. The configuration will take effect after reboot.
5. Click **OK** to reboot the IP phone.  
The system log will be exported successfully after reboot.

**To export a log file to the local system via web user interface:**

1. Click on **Settings->Configuration**.
2. Mark the **Local** radio box in the **Export System Log** field.
3. Click **Export** to open file download window, and then save the file to your local system.

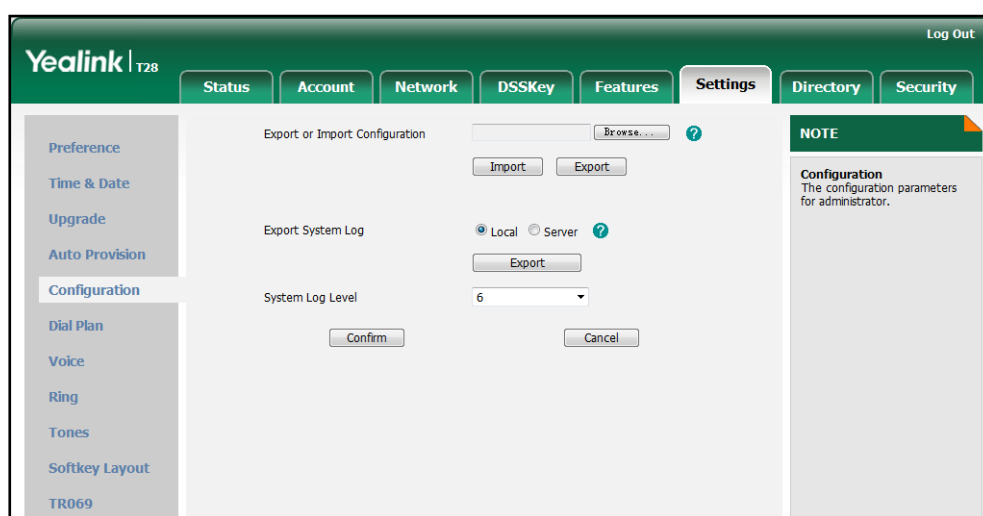

The following figure shows a portion of a log file:

```

496 root      8876 SW    /yealink/bin/ggsvca_ipp
497 root      8876 SW    /yealink/bin/ggsvca_ipp
498 root      8876 SW    /yealink/bin/ggsvca_ipp
499 root      8876 SW    /yealink/bin/ggsvca_ipp
500 root      8876 SW    /yealink/bin/ggsvca_ipp
501 root      8876 SW    /yealink/bin/ggsvca_ipp
507 root      16424 SW   /yealink/bin/Screen.exe
508 root      10344 SW   /yealink/bin/sipServer.exx
509 root      10344 SW   /yealink/bin/sipServer.exx
515 root      16424 SW   /yealink/bin/Screen.exe
517 root      16424 SW   /yealink/bin/Screen.exe
519 root      10344 SW   /yealink/bin/sipServer.exx
521 root      16424 SW   /yealink/bin/Screen.exe
522 root      16424 SW   /yealink/bin/Screen.exe
523 root      16424 SW   /yealink/bin/Screen.exe
524 root      10344 SW   /yealink/bin/sipServer.exx
525 root      SW< [IRQ 45]
526 root      10344 SW   /yealink/bin/sipServer.exx
527 root      16424 SW   /yealink/bin/Screen.exe
528 root      16424 SW   /yealink/bin/Screen.exe
529 root      16424 SW   /yealink/bin/Screen.exe
1147 root     1788 SWN  sleep 1000
1227 root     10120 SWN  ConfigManApp.com
1228 root     4624 SW   /yealink/bin/mini_httpd -p 80 -d /yealink/html -c cgi
1229 root     2812 SWN  sh -c cd /tmp;ifconfig >> Messages;ps >> Messages;tar
1230 root     2812 RWN  ps
Feb 29 06:01:09 mini_httpd[388]: mini_httpd.c(1510):child process 1227 exit!
Feb 29 06:01:12 mini_httpd[1232]: mini_httpd.c(1997):path:/cgi-bin/ConfigManApp.com, query:Id=27
Feb 29 06:01:12 mini_httpd[388]: mini_httpd.c(1510):child process 1232 exit!
Feb 29 06:01:12 mini_httpd[1233]: mini_httpd.c(1997):path:/cgi-bin/ConfigManApp.com, query:Id=27
Feb 29 06:01:12 mini_httpd[388]: mini_httpd.c(1510):child process 1233 exit!
Feb 29 06:01:12 mini_httpd[1234]: mini_httpd.c(1997):path:/cgi-bin/ConfigManApp.com, query:Id=27
Feb 29 06:01:12 mini_httpd[388]: mini_httpd.c(1510):child process 1234 exit!
    
```

## Capturing Packets

You can capture packet in two ways: capturing the packet via web user interface or using the Ethernet software. You can analyze the packet captured for troubleshooting purpose.

**To capture packet via web user interface:**

1. Click on **Settings->Upgrade**.
2. Click **Start** to start capturing signal traffic.
3. Reproduce the issue to get stack traces.
4. Click **Stop** to end capturing.
5. Click **Export** to open the file download window, and then save the file to your local system.

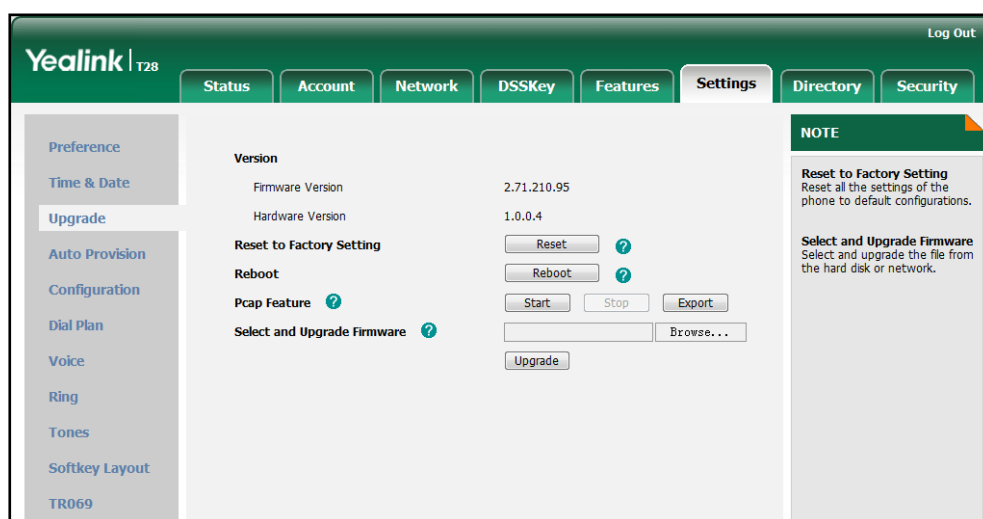

**To capture packet using the Ethernet software:**

Connect the Internet port of the IP phone and the PC to the same HUB, and then use Sniffer, Ethereal or Wireshark software to capture the signal traffic.

## Enabling Watch Dog Feature

The IP phone provides a troubleshooting feature called "Watch Dog", which helps you monitor the IP phone status and provides the ability to get stack traces from the last time the IP phone failed. When Watch Dog feature is enabled, the IP phone will automatically reboot when it detects a fatal failure. This feature can be configured using the configuration files or the web user interface.

You can use the "watch\_dog.enable" parameter to configure Watch Dog feature in the configuration files. For more information, refer to [Watch Dog](#) on page 376.

To configure watch dog feature via web user interface:

1. Click on **Settings->Preference**.
2. Select the desired value from the pull-down list of **Watch Dog**.

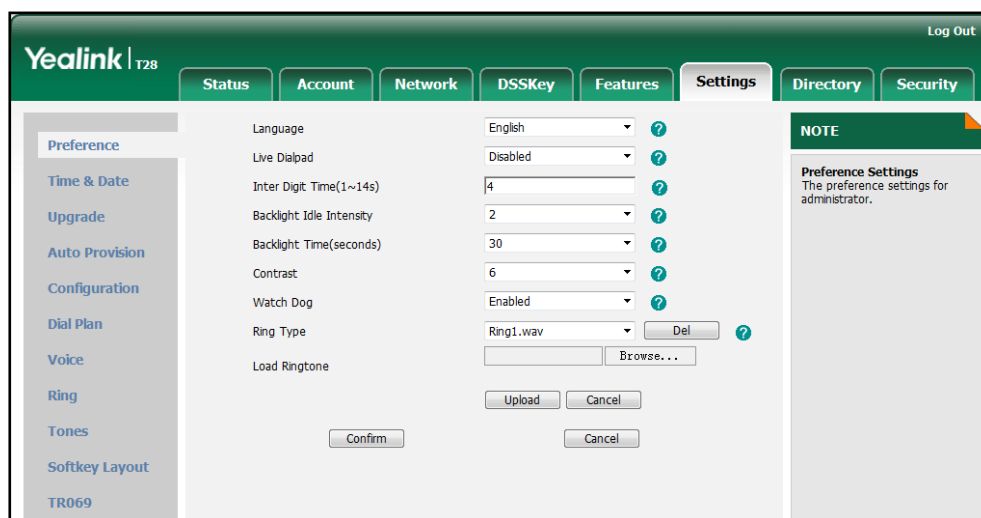

3. Click **Confirm** to accept the change.

## Getting Information from Status Indicators

Status indicators may consist of the power LED, MESSAGE key LED, line key indicator, headset key indicator and the on-screen icon or error messages.

The following shows two examples of getting the phone information from status indicators:

- If a LINK failure of the IP phone is detected, a prompting message “Network Unavailable” and the icon  appear on the LCD screen.
- If a voice mail is received, the MESSAGE key LED illuminates.

For more information on the icons, refer to [Reading Icons](#) on page 20.

## Analyzing Configuration File

Wrong configurations may have an impact on your phone use. You can export configuration file to check the current configuration of the IP phone and troubleshoot if necessary.

To export configuration file via web user interface:

1. Click on **Settings->Configuration**.

2. In the **Export or Import Configuration** block, click **Export** to open the file download window, and then save the file to your local system.

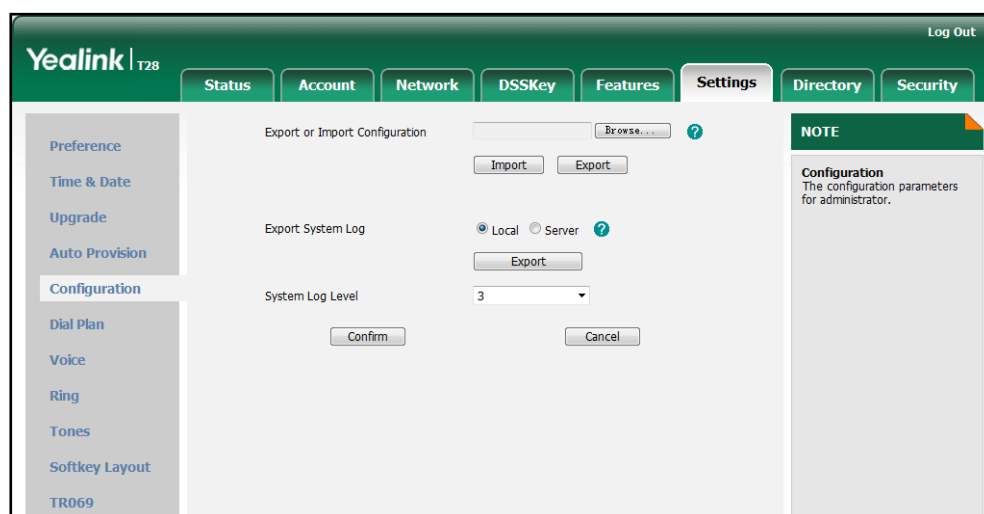

## Troubleshooting Solutions

This section describes solutions to common issues that may occur while using the IP phone. Upon encountering a scenario not listed in this section, contact your Yealink reseller for further support.

### Why is the LCD screen blank?

Do one of the following:

- Ensure that the IP phone is properly plugged into a functional AC outlet.
- Ensure that the IP phone is plugged into a socket controlled by a switch that is on.
- If the IP phone is plugged into a power strip, try plugging it directly into a wall outlet.
- If your phone is PoE powered, ensure you are using a PoE-compliant switch or hub.

### Why doesn't the IP phone get an IP address?

Do one of the following:

- Ensure that the Ethernet cable is plugged into the Internet port on the IP phone and the Ethernet cable is not loose.
- Ensure that the Ethernet cable is not damaged.
- Ensure that the IP address and related network parameters are set correctly.
- Ensure that your network switch or hub is operational.

## Why does the IP phone display “No Service”?

The LCD screen prompts “No Service” message when there is no available SIP account on the IP phone.

Do one of the following:

- Ensure that an account is actively registered on the IP phone at the path **Menu->Status->More->Accounts**.
- Ensure that the SIP account parameters have been set up correctly.

## How do I find the basic information of the IP phone?

Press the **OK** key when the IP phone is idle to check the basic information (e.g., IP address MAC address and firmware version).

## Why doesn't the IP phone upgrade firmware successfully?

Do one of the following:

- Ensure that the target firmware is not the same as the current firmware.
- Ensure that the target firmware is applicable to the IP phone model.
- Ensure that the current or the target firmware is not protected.
- Ensure that the power is on and the network is available in the process of upgrading.
- Ensure that the web browser is not closed and refreshed when upgrading firmware using the web user interface.

## Why doesn't the IP phone display time and date correctly?

Check if the IP phone is configured to obtain the time and date from the NTP server automatically. If your phone is unable to access the NTP server, configure the time and date manually.

## Why do I get poor sound quality during a call?

If you have poor sound quality/acoustics like intermittent voice, low volume, echo or other noises, the possible reasons could be:

- Users are seated too far out of recommended microphone range and sound faint, or are seated too close to sensitive microphones and cause echo.
- Intermittent voice is mainly caused by packet loss, due to network congestion, and

jitter, due to message recombination of transmission or receiving equipment (e.g., timeout handling, retransmission mechanism, buffer under run).

- Noisy equipment, such as a computer or a fan, may cause voice interference. Turn off any noisy equipment.
- Line issues can also cause this problem; disconnect the old line and redial the call to ensure another line may provide better connection.

## What is the difference between a remote phone book and a local phone book?

A remote phone book is placed on a server, while a local phone book is placed on the IP phone flash. A remote phone book can be used by everyone that can access the server, while a local phone book can only be used by a specific phone. A remote phone book is always used as a central phone book for a company; each employee can load it to obtain the real-time data from the same server.

## What is the difference between user name, register name and display name?

Both user name and register name are defined by the server. User name identifies the account, while register name matched with a password is for authentication purposes. Display name is the caller ID that will be displayed on the callee's phone LCD screen. Server configurations may override the local ones.

## How to reboot the IP phone remotely?

IP phones support remote reboot by a SIP NOTIFY message with "Event: check-sync" header. When receiving a NOTIFY message with the parameter "reboot=true", the IP phone reboots immediately. The NOTIFY message is formed as shown:

```
NOTIFY sip:<user>@<dsthost> SIP/2.0
To: sip:<user>@<dsthost>
From: sip:sipsak@<srchost>
CSeq: 10 NOTIFY
Call-ID: 1234@<srchost>
Event: check-sync;reboot=true
```



## Why does the IP phone use DOB format logo file instead of popular BMP, JPG and so on?

The IP phone only uses logo file in DOB format, as the DOB format file has a high compression ratio (the size of the uncompressed file compared to that of the compressed file) and can be stored in less space. Tools for converting BMP format to DOB format are available. For more information, refer to *Yealink SIP-T2 Series/T3 Series/T19P/VP530 IP Phones Auto Provisioning Guide*.

## How to increase or decrease the volume?

Press the volume key to increase or decrease the ringer volume when the phone is idle, or to tune the volume of engaged audio device (handset, speakerphone or headset) when there is an active call in progress.

## What will happen if I connect both PoE cable and power adapter?

### Which has the higher priority?

IP phones manufactured before February 2010 will use the power adapter preferentially, while those made after will use PoE preferentially.

## What is auto provisioning?

Auto provisioning refers to the update of IP phones, including update on configuration parameters, local phone book, firmware and so on. You can use auto provisioning on a single phone, but it makes more sense in mass deployment.

## What is PnP?

Plug and Play (PnP) is a method for IP phones to acquire the provisioning server address. With PnP enabled, the IP phone broadcasts the PnP SUBSCRIBE message to obtain a provisioning server address during startup. Any SIP server recognizing the message will respond with the preconfigured provisioning server address, so the IP phone will be able to download the CFG files from the provisioning server. PnP depends on support from a SIP server.

## Why doesn't the IP phone update the configuration?

Do one of the following:

- Ensure that the configuration is set correctly.
- Reboot the IP phone. Some configurations require a reboot to take effect.
- Ensure that the configuration is applicable to the IP phone model.
- The configuration may depend on support from the server.

## What do "on code" and "off code" mean?

They are codes that the IP phone sends to the server when a certain action takes place. On code is used to activate a feature on the server side, while off code is used to deactivate a feature on the server side.

For example, if you set the Always Forward on code to be \*78 (may vary on different servers), and the target number to be 201. When you enable Always Forward on the IP phone, the IP phone sends \*78201 to the server, and then the server will enable Always Forward feature on the server side, hence being able to get the right status of the extension

## How to solve the IP conflict problem?

Do one of the following:

- Reset another available IP address for the IP phone.
- Check network configuration via phone user interface at the path **Menu->Settings->Advanced Settings->Network->WAN Port->IPv4**. If Static IP Client is selected, select DHCP IP Client instead.

## How to reset the IP phone to factory configurations?

Reset your phone to factory configurations after you have tried all troubleshooting suggestions but do not solve the problem. Note that all customized settings will be overwritten after resetting.

**To reset the IP phone via web user interface:**

1. Click on **Settings->Upgrade**.
2. Click **Reset** in the **Reset to Factory Setting** field.

The web user interface prompts the message “Do you want to reset to factory?”.

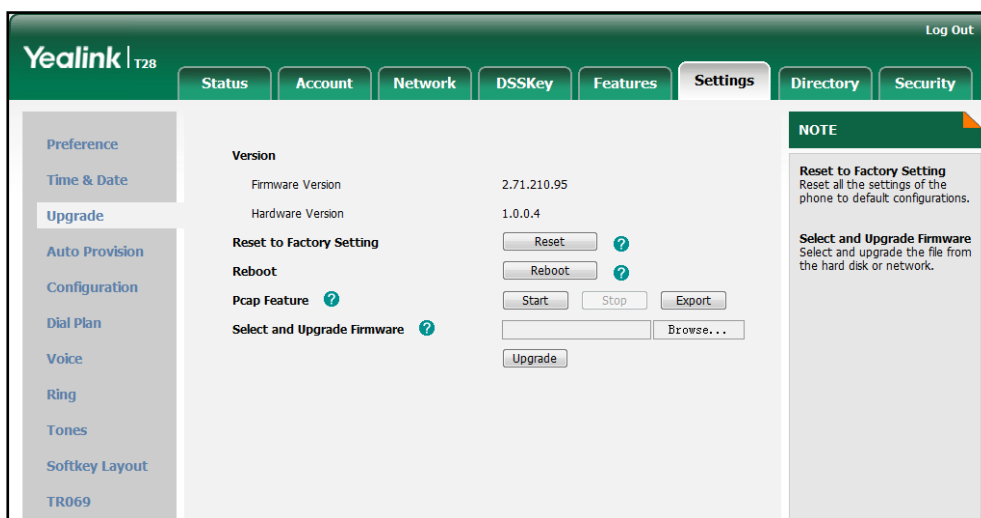

3. Click **OK** to confirm the resetting.  
The phone will be reset to factory successfully after startup.

**Note** Reset of your phone may take a few minutes. Do not power off until the phone starts up successfully.

## How to restore the administrator password?

Factory reset can restore the original password, by pressing the OK key when the IP phone is idle. All customized settings will be overwritten after reset.

## What are the main differences between T28P, T26P, T22P and T20P?

Phone Model	LCD	Logo Display	Line Key	Memory Key	SMS	XML Browser
SIP-T28P	320*160 pixel	236*82 pixel	6	10	Support	Support
SIP-T26P	132*64 pixel	132*64 pixel	3	10	Support	Support
SIP-T22P	132*64 pixel	132*64 pixel	3	/	Support	Support
SIP-T21P	132*64 pixel	132*64 pixel	2	/	Support	Support

Phone Model	LCD	Logo Display	Line Key	Memory Key	SMS	XML Browser
SIP-T20P	3-line (2*15 characters and an icon line)	Text log	2	/	Support (Send text messages via web user interface)	Support (Non UI)
SIP-T19P	132*64 pixel	132*64 pixel	/	/	Support	Support

---

# Appendix

---

## Appendix A: Glossary

**802.1x**--an IEEE Standard for port-based Network Access Control (PNAC). It is part of the IEEE 802.1 group of networking protocols. It provides an authentication mechanism to devices wishing to attach to a LAN or WLAN.

**ACD (Automatic Call Distribution)**--used to distribute calls from large volumes of incoming calls to the registered IP phone users.

**ACS (Auto Configuration server)**--responsible for auto-configuration of the Central Processing Element (CPE).

**Cryptographic Key**--a piece of variable data that is fed as input into a cryptographic algorithm to perform operations such as encryption and decryption, or signing and verification.

**DHCP (Dynamic Host Configuration Protocol)**--built on a client-server model, where designated DHCP server hosts allocate network addresses and deliver configuration parameters to dynamically configured hosts.

**DHCP Option**--can be configured for specific values and enabled for assignment and distribution to DHCP clients based on server, scope, class or client-specific levels.

**DNS (Domain Name System)**--a hierarchical distributed naming system for computers, services, or any resource connected to the Internet or a private network.

**EAP-MD5 (Extensible Authentication Protocol-Message Digest Algorithm 5)**--only provides authentication of the EAP peer to the EAP server but not mutual authentication.

**EAP-TLS (Extensible Authentication Protocol-Transport Layer Security)** --Provides for mutual authentication, integrity-protected cipher suite negotiation between two endpoints.

**PEAP-MSCHAPv2 (Protected Extensible Authentication Protocol-Microsoft Challenge Handshake Authentication Protocol version 2)** --Provides for mutual authentication, but does not require a client certificate on the IP phone.

**FAC (Feature Access Code)**--special patterns of characters that are dialed from a phone keypad to invoke particular features.

**HTTP (Hypertext Transfer Protocol)**--used to request and transmit data on the World Wide Web.

**HTTPS (Hypertext Transfer Protocol over Secure Socket Layer)**--a widely-used communications protocol for secure communication over a network.

**IEEE** (Institute of Electrical and Electronics Engineers)--a non-profit professional association headquartered in New York City that is dedicated to advancing technological innovation and excellence.

**LAN** (Local Area Network)--used to interconnects network devices in a limited area such as a home, school, computer laboratory, or office building.

**MIB** (Management Information Base)--a virtual database used for managing the entities in a communications network.

**OID** (Object Identifier)--assigned to an individual object within a MIB.

**PnP** (Plug and Play)--a term used to describe the characteristic of a computer bus, or device specification, which facilitates the discovery of a hardware component in a system, without the need for physical device configuration, or user intervention in resolving resource conflicts.

**ROM** (Read-only Memory)--a class of storage medium used in computers and other electronic devices.

**RTP** (Real-time Transport Protocol)--provides end-to-end service for real-time data.

**TCP** (Transmission Control Protocol)--a transport layer protocol used by applications that require guaranteed delivery.

**UDP** (User Datagram Protocol)--a protocol offers non-guaranteed datagram delivery.

**URI** (Uniform Resource Identifier)--a compact sequence of characters that identifies an abstract or physical resource.

**URL** (Uniform Resource Locator)--specifies the address of an Internet resource.

**VLAN** (Virtual LAN)-- a group of hosts with a common set of requirements, which communicate as if they were attached to the same broadcast domain, regardless of their physical location.

**VoIP** (Voice over Internet Protocol)--a family of technologies used for the delivery of voice communications and multimedia sessions over IP networks.

**WLAN** (Wireless Local Area Network)--a type of local area network that uses high-frequency radio waves rather than wires to communicate between nodes.

**XML-RPC** (Remote Procedure Call Protocol)--which uses XML to encode its calls and HTTP as a transport mechanism.

## Appendix B: Time Zones

Time Zone	Time Zone Name
-11:00	Samoa
-10:00	United States-Hawaii-Aleutian
-10:00	United States-Alaska-Aleutian
-09:00	United States-Alaska Time
-08:00	Canada(Vancouver, Whitehorse)
-08:00	Mexico(Tijuana, Mexicali)
-08:00	United States-Pacific Time
-07:00	Canada(Edmonton, Calgary)
-07:00	Mexico(Mazatlan, Chihuahua)
-07:00	United States-Mountain Time
-07:00	United States-MST no DST
-06:00	Canada-Manitoba(Winnipeg)
-06:00	Chile(Easter Islands)
-06:00	Mexico(Mexico City, Acapulco)
-06:00	United States-Central Time
-05:00	Bahamas(Nassau)
-05:00	Canada(Montreal, Ottawa, Quebec)
-05:00	Cuba(Havana)
-05:00	United States-Eastern Time
-04:30	Venezuela(Caracas)
-04:00	Canada(Halifax, Saint John)
-04:00	Chile(Santiago)
-04:00	Paraguay(Asuncion)
-04:00	United Kingdom-Bermuda(Bermuda)
-04:00	United Kingdom(Falkland Islands)
-04:00	Trinidad&Tobago
-03:30	Canada-New Foundland(St.Johns)
-03:00	Denmark-Greenland(Nuuk)
-03:00	Argentina(Buenos Aires)
-03:00	Brazil(no DST)
-03:00	Brazil(DST)
-02:00	Brazil(no DST)
-01:00	Portugal(Azores)
0	GMT
0	Greenland
0	Denmark-Faroe Islands(Torshavn)
0	Ireland(Dublin)
0	Portugal(Lisboa, Porto, Funchal)
0	Spain-Canary Islands(Las Palmas)

Time Zone	Time Zone Name
0	United Kingdom(London)
0	Morocco
+01:00	Albania(Tirane)
+01:00	Austria(Vienna)
+01:00	Belgium(Brussels)
+01:00	Caicos
+01:00	Chad
+01:00	Croatia(Zagreb)
+01:00	Czech Republic(Prague)
+01:00	Denmark(Kopenhagen)
+01:00	France(Paris)
+01:00	Germany(Berlin)
+01:00	Hungary(Budapest)
+01:00	Italy(Rome)
+01:00	Luxembourg(Luxembourg)
+01:00	Macedonia(Skopje)
+01:00	Netherlands(Amsterdam)
+01:00	Namibia(Windhoek)
+02:00	Estonia(Tallinn)
+02:00	Finland(Helsinki)
+02:00	Gaza Strip(Gaza)
+02:00	Greece(Athens)
+02:00	Israel(Tel Aviv)
+02:00	Jordan(Amman)
+02:00	Latvia(Riga)
+02:00	Lebanon(Beirut)
+02:00	Moldova(Kishinev)
+02:00	Russia(Kaliningrad)
+02:00	Romania(Bucharest)
+02:00	Syria(Damascus)
+02:00	Turkey(Ankara)
+02:00	Ukraine(Kyiv, Odessa)
+03:00	East Africa Time
+03:00	Iraq(Baghdad)
+03:00	Russia(Moscow)
+03:30	Iran(Teheran)
+04:00	Armenia(Yerevan)
+04:00	Azerbaijan(Baku)
+04:00	Georgia(Tbilisi)
+04:00	Kazakhstan(Aktau)
+04:00	Russia(Samara)
+04:30	Afghanistan



Time Zone	Time Zone Name
+05:00	Kazakhstan(Aqtobe)
+05:00	Kyrgyzstan(Bishkek)
+05:00	Pakistan(Islamabad)
+05:00	Russia(Chelyabinsk)
+05:30	India(Calcutta)
+06:00	Kazakhstan(Astana, Almaty)
+06:00	Russia(Novosibirsk, Omsk)
+07:00	Russia(Krasnoyarsk)
+07:00	Thailand(Bangkok)
+08:00	China(Beijing)
+08:00	Singapore(Singapore)
+08:00	Australia(Perth)
+09:00	Korea(Seoul)
+09:00	Japan(Tokyo)
+09:30	Australia(Adelaide)
+09:30	Australia(Darwin)
+10:00	Australia(Sydney, Melbourne, Canberra)
+10:00	Australia(Brisbane)
+10:00	Australia(Hobart)
+10:00	Russia(Vladivostok)
+10:30	Australia(Lord Howe Islands)
+11:00	New Caledonia(Noumea)
+12:00	New Zealand(Wellington, Auckland)
+12:45	New Zealand(Chatham Islands)
+13:00	Tonga(Nukualofa)

## Appendix C: Configuration Parameters

This appendix describes configuration parameters in the configuration files for each feature. The configuration files are <y0000000000xx>.cfg and <MAC>.cfg.

### Setting Parameters in Configuration Files

You can set parameters in the configuration files to configure IP phones. The <y0000000000xx>.cfg and <MAC>.cfg files are stored on the provisioning server. The IP phone checks for configuration files and looks for resource files when restarting the IP phone. The <y0000000000xx>.cfg file stores configurations for all phones of the same model. The <MAC>.cfg file stores configurations for a specific IP phone with that MAC address.

Configuration changes made in the <MAC>.cfg file override the configuration settings in the <y0000000000xx>.cfg file.

### Basic and Advanced Parameters

#### DHCP

Parameter-	Configuration File
network.internet_port.type	<MAC>.cfg
<b>Description</b>	Defines the Internet port type. <b>Note:</b> If you change this parameter, the IP phone will reboot to make the change take effect.
<b>Format</b>	Integer
<b>Default Value</b>	0
<b>Range</b>	<b>Valid values are:</b> 0-DHCP 1-PPPoE 2-Static IP Address
<b>Example</b>	network.internet_port.type= 0

## Static Network Settings

Parameter-	Configuration File
network.internet_port.type	<MAC>.cfg
<b>Description</b>	Defines the Internet port type. <b>Note:</b> If you change this parameter, the IP phone will reboot to make the change take effect.
<b>Format</b>	Integer
<b>Default Value</b>	0
<b>Range</b>	<b>Valid values are:</b> 0-DHCP 1-PPPoE 2-Static IP Address
<b>Example</b>	network.internet_port.type = 2

Parameter-	Configuration File
network.ip_address_mode	<MAC>.cfg
<b>Description</b>	Defines the IP address mode. IP phones support to use the IPv4 address only, the IPv6 address only or both IPv4 and IPv6 addresses. <b>Note:</b> If you change this parameter, the IP phone will reboot to make the change take effect.
<b>Format</b>	Integer
<b>Default Value</b>	0
<b>Range</b>	<b>Valid values are:</b> 0-IPv4 1-IPv6 2-IPv4&IPv6
<b>Example</b>	network.ip_address_mode = 0

Parameter-	Configuration File
network.internet_port.ip	<MAC>.cfg
<b>Description</b>	Configures the IP address when the Internet

	<p>port type is configured as Static IP Address and the IP address mode is configured as IPv4 or IPv4&amp;IPv6.</p> <p><b>Note:</b> If you change this parameter, the IP phone will reboot to make the change take effect.</p>
<b>Format</b>	IP Address
<b>Default Value</b>	Blank
<b>Range</b>	Not Applicable
<b>Example</b>	network.internet_port.ip = 192.168.1.20

<b>Parameter-</b> network.internet_port.mask	<b>Configuration File</b> <MAC>.cfg
<b>Description</b>	<p>Configures the subnet mask when the Internet port type is configured as Static IP Address and the IP address mode is configured as IPv4 or IPv4&amp;IPv6.</p> <p><b>Note:</b> If you change this parameter, the IP phone will reboot to make the change take effect.</p>
<b>Format</b>	IP Address
<b>Default Value</b>	Blank
<b>Range</b>	Not Applicable
<b>Example</b>	network.internet_port.mask = 255.255.255.0

<b>Parameter-</b> network.internet_port.gateway	<b>Configuration File</b> <MAC>.cfg
<b>Description</b>	<p>Configures the default gateway when the Internet port type is configured as Static IP Address and the IP address mode is configured as IPv4 or IPv4&amp;IPv6.</p> <p><b>Note:</b> If you change this parameter, the IP phone will reboot to make the change take effect.</p>
<b>Format</b>	IP Address
<b>Default Value</b>	Blank

<b>Range</b>	Not Applicable
<b>Example</b>	network.internet_port.gateway = 192.168.1.254

<b>Parameter-</b> network.primary_dns	<b>Configuration File</b> <MAC>.cfg
<b>Description</b>	Configures the primary DNS server when the Internet port type is configured as Static IP Address and the IP address mode is configured as IPv4 or IPv4&IPv6.  <b>Note:</b> If you change this parameter, the IP phone will reboot to make the change take effect.
<b>Format</b>	IP Address
<b>Default Value</b>	202.101.103.55
<b>Range</b>	Not Applicable
<b>Example</b>	network.primary_dns = 202.101.103.5

<b>Parameter-</b> network.secondary_dns	<b>Configuration File</b> <MAC>.cfg
<b>Description</b>	Configures the secondary DNS server when the Internet port type is configured as Static IP Address and the IP address mode is configured as IPv4 or IPv4&IPv6.  <b>Note:</b> If you change this parameter, the IP phone will reboot to make the change take effect.
<b>Format</b>	IP Address
<b>Default Value</b>	202.101.103.56
<b>Range</b>	Not Applicable
<b>Example</b>	network.secondary_dns = 202.101.103.6

## PPPoE

Parameter-	Configuration File
network.internet_port.type	<MAC>.cfg
<b>Description</b>	Defines the Internet port type. <b>Note:</b> If you change this parameter, the IP phone will reboot to make the change take effect.
<b>Format</b>	Integer
<b>Default Value</b>	0
<b>Range</b>	<b>Valid values are:</b> 0-DHCP 1-PPPoE 2-Static IP Address
<b>Example</b>	network.internet_port.type = 1

Parameter-	Configuration File
network.pppoe.user	<y0000000000xx>.cfg
<b>Description</b>	Configures the PPPoE user name when the Internet port type is configured as PPPoE. <b>Note:</b> If you change this parameter, the IP phone will reboot to make the change take effect.
<b>Format</b>	String
<b>Default Value</b>	Blank
<b>Range</b>	0 to 32 characters
<b>Example</b>	network.pppoe.user = xmyealink

Parameter-	Configuration File
network.pppoe.password	<y0000000000xx>.cfg
<b>Description</b>	Configures the PPPoE password when the Internet port type is configured as PPPoE. <b>Note:</b> If you change this parameter, the IP phone will reboot to make the change take effect.

<b>Format</b>	String
<b>Default Value</b>	Blank
<b>Range</b>	0 to 99 characters
<b>Example</b>	network.pppoe.password = yealink123

## Internet and PC Ports Transmission Methods

### Internet Port Transmission Method

<b>Parameter-</b> network.internet_port.speed_duplex	<b>Configuration File</b> <y0000000000xx>.cfg
<b>Description</b>	Specifies the transmission method of Internet port. <b>Note:</b> We recommend that you do not change this parameter.
<b>Format</b>	Integer
<b>Default Value</b>	0
<b>Range</b>	<b>Valid values are:</b> 0-Auto negotiate 1-Full duplex, 10Mbps 2-Full duplex, 100Mbps 3-Half duplex, 10Mbps 4-Half duplex, 100Mbps
<b>Example</b>	network.internet_port.speed_duplex = 0

### PC Port Transmission Method

<b>Parameter-</b> network.pc_port.speed_duplex	<b>Configuration File</b> <y0000000000xx>.cfg
<b>Description</b>	Specifies the transmission method of PC port. <b>Note:</b> We recommend that you do not change this parameter.
<b>Format</b>	Integer
<b>Default Value</b>	0
<b>Range</b>	<b>Valid values are:</b> 0-Auto negotiate 1-Full duplex, 10Mbps

	<b>2</b> -Full duplex, 100Mbps <b>3</b> -Half duplex, 10Mbps <b>4</b> -Half duplex, 100Mbps
<b>Example</b>	network.pc_port.speed_duplex = 0

## PC Port Mode

Parameter-	Configuration File
network.PC_port.enable	<y0000000000xx>.cfg
<b>Description</b>	Enables or disables the PC port. <b>Note:</b> If you change this parameter, the IP phone will reboot to make the change take effect.
<b>Format</b>	Boolean
<b>Default Value</b>	1
<b>Range</b>	<b>Valid values are:</b> <b>0</b> -Disabled <b>1</b> -Auto-negotiation
<b>Example</b>	network.PC_port.enable = 1

Parameter-	Configuration File
network.bridge_mode	<y0000000000xx>.cfg
<b>Description</b>	Configures the PC port mode. <b>Note:</b> If you change this parameter, the IP phone will reboot to make the change take effect. It is not applicable to SIPT19P and SIP-T21P IP phones.
<b>Format</b>	Integer
<b>Default Value</b>	1
<b>Range</b>	<b>Valid values are:</b> <b>0</b> -Router <b>1</b> -Bridge
<b>Example</b>	network.bridge_mode = 1



Parameter-	Configuration File
network.pc_port.ip	<y0000000000xx>.cfg
<b>Description</b>	Configures the IP address for the PC port when the PC port is configured as Router. <b>Note:</b> If you change this parameter, the IP phone will reboot to make the change take effect. It is not applicable to SIP-T19P and SIP-T21P IP phones.
<b>Format</b>	IP Address
<b>Default Value</b>	10.0.0.1
<b>Range</b>	Not Applicable
<b>Example</b>	network.pc_port.ip = 10.0.0.1

Parameter-	Configuration File
network.pc_port.mask	<y0000000000xx>.cfg
<b>Description</b>	Configures the subnet mask for the PC port when the PC port is configured as Router. <b>Note:</b> If you change this parameter, the IP phone will reboot to make the change take effect. It is not applicable to SIP-T19P and SIP-T21P IP phones.
<b>Format</b>	IP Address
<b>Default Value</b>	255.255.255.0
<b>Range</b>	Not Applicable
<b>Example</b>	network.pc_port.mask = 255.255.255.0

Parameter-	Configuration File
network.pc_port.dhcp_server	<y0000000000xx>.cfg
<b>Description</b>	Enables or disables the DHCP service for the PC attached to the PC port when the PC port is configured as Router. <b>Note:</b> If you change this parameter, the IP phone will reboot to make the change take effect. It is not applicable to SIP-T19P and SIP-T21P IP phones.
<b>Format</b>	Boolean

<b>Default Value</b>	1
<b>Range</b>	0-Disabled 1-Enabled
<b>Example</b>	network.pc_port.dhcp_server = 1

<b>Parameter-</b>	<b>Configuration File</b>
network.dhcp.start_ip	<y0000000000xx>.cfg
<b>Description</b>	Configures the start IP address that the IP phone assigns for the PC attached to the PC port when the PC port is configured as Router. <b>Note:</b> If you change this parameter, the IP phone will reboot to make the change take effect. It is not applicable to SIPT19P and SIPT21P IP phones.
<b>Format</b>	IP Address
<b>Default Value</b>	10.0.0.10
<b>Range</b>	Not Applicable
<b>Example</b>	network.dhcp.start_ip = 10.0.0.10

<b>Parameter-</b>	<b>Configuration File</b>
network.dhcp.end_ip	<y0000000000xx>.cfg
<b>Description</b>	Configures the end IP address that the IP phone assigns for the PC attached to the PC port when the PC port is configured as Router. <b>Note:</b> If you change this parameter, the IP phone will reboot to make the change take effect. It is not applicable to SIPT19P and SIPT21P IP phones.
<b>Format</b>	IP Address
<b>Default Value</b>	10.0.0.100
<b>Range</b>	Not Applicable
<b>Example</b>	network.dhcp.end_ip = 10.0.0.100

## Dial Plan

### Replace Rule

Parameter- dialplan.item.x	Configuration File <y0000000000xx>.cfg
<b>Description</b>	<p>Creates the replace rule.</p> <p>dialplan.item.x =Enabled, Prefix, Replaced, Line ID</p> <p><b>Enabled:</b> Enables or disables the replace rule.</p> <p><b>Prefix:</b> Specifies the string you want to replace.</p> <p><b>Replaced:</b> Specifies the alternate string instead of what the user enters.</p> <p><b>Line ID:</b> Specifies the desired line to apply this replace rule. The digit 0 stands for all lines. X ranges from 1 to 100.</p> <p><b>Note:</b> Multiple line IDs are separated by comma.</p>
<b>Format</b>	Boolean, String, String, Integer
<b>Default Value</b>	Blank
<b>Range</b>	<p><b>Valid values of Enabled are:</b></p> <p>0-Disabled</p> <p>1-Enabled</p> <p><b>Prefix, Replaced:</b> Not Applicable</p> <p><b>Valid values of Line ID are:</b></p> <p>0 to 6 (for T28P)</p> <p>0 to 3 (for T26P/T20P)</p> <p>0 to 2 (for T21P/T20P)</p> <p>0 to 1 (for T19P)</p>
<b>Example</b>	dialplan.item.1 = 1,123,0592,1,2,3

### Dial-now

Parameter- dialnow.item.x	Configuration File <y0000000000xx>.cfg
<b>Description</b>	<p>Creates the dial-now rule.</p> <p>dialnow.item.x = Dial-now Rule, Line ID</p> <p><b>Dial-now Rule:</b> Specifies the string used to match the numbers entered by the user. When</p>

	<p>entered numbers match the predefined dial-now rule, the IP phone will automatically dial out the numbers without pressing the send key.</p> <p><b>Line ID:</b> Specifies the desired line to apply this dial-now rule. The digit 0 stands for all lines. X ranges from 1 to 100.</p> <p><b>Note:</b> Multiple line IDs are separated by comma.</p>
<b>Format</b>	String, Integer
<b>Default Value</b>	Blank
<b>Range</b>	<p><b>Dial-now Rules:</b> Not Applicable</p> <p><b>Valid values of Line ID are:</b></p> <p>0 to 6 (for T28P)                  0 to 3 (for T26P/T20P)                  0 to 2 (for T21P/T20P)                  0 to 1 (for T19P)</p>
<b>Example</b>	dialnow.item.1 = 2216,1,2,3

Parameter-	Configuration File
phone_setting.dialnow_delay	<y0000000000xx>.cfg
<b>Description</b>	<p>Configures the delay time (in seconds) for the dial-now rule.</p> <p>When entered numbers match the predefined dial-now rule, the IP phone will automatically dial out the entered number after the specified delay time.</p>
<b>Format</b>	Integer
<b>Default Value</b>	1
<b>Range</b>	1 to 14
<b>Example</b>	phone_setting.dialnow_delay = 1

**Area Code**

Parameter-	Configuration File
dialplan.area_code.code	<y0000000000xx>.cfg
<b>Description</b>	Defines the area code to add before the entered numbers.

<b>Format</b>	Integer
<b>Default Value</b>	Blank
<b>Range</b>	Not Applicable
<b>Example</b>	dialplan.area_code.code = 010

<b>Parameter-</b> dialplan.area_code.min_len	<b>Configuration File</b> <y0000000000xx>.cfg
<b>Description</b>	Sets the minimum length of the entered numbers.
<b>Format</b>	Integer
<b>Default Value</b>	1
<b>Range</b>	1 to 15
<b>Example</b>	dialplan.area_code.min_len = 2

<b>Parameter-</b> dialplan.area_code.max_len	<b>Configuration File</b> <y0000000000xx>.cfg
<b>Description</b>	Sets the maximum length of the entered numbers. <b>Note:</b> The value must be larger than the minimum length.
<b>Format</b>	Integer
<b>Default Value</b>	15
<b>Range</b>	1 to 15
<b>Example</b>	dialplan.area_code.max_len = 13

<b>Parameter-</b> dialplan.area_code.line_id	<b>Configuration File</b> <y0000000000xx>.cfg
<b>Description</b>	Specifies the desired line to apply this area code rule. The digit 0 stands for all lines. <b>Note:</b> Multiple line IDs are separated by comma.
<b>Format</b>	Integer
<b>Default Value</b>	Blank (for all lines)
<b>Range</b>	<b>Valid values are:</b>

	0 to 6 (for T28P) 0 to 3 (for T26P/T20P) 0 to 2 (for T21P/T20P) 0 to 1 (for T19P)
<b>Example</b>	dialplan.area_code.line_id = 1,2

### Block Out

Parameter-	Configuration File
dialplan.block_out.number.x	<y0000000000xx>.cfg
<b>Description</b>	Specifies the block out numbers. X ranges from 1 to 10.
<b>Format</b>	String
<b>Default Value</b>	Blank
<b>Range</b>	Not Applicable
<b>Example</b>	dialplan.block_out.number.1 = 1234

Parameter-	Configuration File
dialplan.block_out.line_id.x	<y0000000000xx>.cfg
<b>Description</b>	Specifies the desired line to apply this block out rule. The digit 0 stands for all lines. X ranges from 1 to 10. <b>Note:</b> Multiple line IDs are separated by comma.
<b>Format</b>	Integer
<b>Default Value</b>	Blank (for all lines)
<b>Range</b>	<b>Valid values are:</b> 0 to 6 (for T28P) 0 to 3 (for T26P/T20P) 0 to 2 (for T21P/T20P) 0 to 1 (for T19P)
<b>Example</b>	dialplan.block_out.line_id.1 = 1,2,3

## Contrast

Parameter-	Configuration File
phone_setting.contrast	<y0000000000xx>.cfg
Description	Configures the contrast of the LCD screen. <b>Note:</b> We recommend that you set the contrast of the LCD screen to 6 as a more comfortable level. It is applicable to SIP-T19P, SIP-T21P and SIP-T28P IP phones.
Format	Integer
Default Value	6
Range	1 to 10
Example	phone_setting.contrast = 6

## Backlight

Parameter-	Configuration File
phone_setting.active_backlight_level	<y0000000000xx>.cfg
Description	Configures the backlight idle intensity used to adjust the backlight intensity of the LCD screen Level 3 is the brightest. <b>Note:</b> It is only applicable to the SIPT28P IP phone.
Format	Integer
Default Value	2
Range	1 to 3
Example	phone_setting.active_backlight_level = 1

Parameter-	Configuration File
phone_setting.backlight_time	<y0000000000xx>.cfg
Description	Configures the backlight time (in seconds) used to specify the delay time to turn off the backlight when the IP phone is inactive. If set to 60 (60s), the LCD backlight is turned off

	when the IP phone is inactive for 60 seconds. <b>Note:</b> It is not applicable to SIP-T19P and SIP-T21P IP phones.
<b>Format</b>	Integer
<b>Default Value</b>	30
<b>Range</b>	<b>Valid values are:</b> 0-Always off 1-Always on 15-15s 30-30s 60-60s 120-120s
<b>Example</b>	phone_setting.backlight_time = 0

## User Password

Parameter-	Configuration File
security.user_password	<y0000000000xx>.cfg
<b>Description</b>	Sets a new user password for the IP phone. The IP phone uses "user" as the default user password. <b>Note:</b> IP phones support ASCII characters 32-126(0x20-0x7E) only in passwords.
<b>Format</b>	username:new password
<b>Default Value</b>	user
<b>Range</b>	ASCII characters 32-126(0x20-0x7E)
<b>Example</b>	security.user_password = user:password123

## Administrator Password

Parameter-	Configuration File
security.user_password	<y0000000000xx>.cfg
<b>Description</b>	Sets a new administrator password for the IP phone. The IP phone uses "admin" as the default administrator password. <b>Note:</b> IP phones support ASCII characters



	32-126(0x20-0x7E) only in passwords.
<b>Format</b>	administrator username:new password
<b>Default Value</b>	admin
<b>Range</b>	ASCII characters 32-126(0x20-0x7E)
<b>Example</b>	security.user_password = admin:password000

## Phone Lock

Parameter-	Configuration File
phone_setting.lock	<y0000000000xx>.cfg
<b>Description</b>	<p>Specifies the type of phone lock.</p> <p><b>Menu Key:</b> The Menu soft key and MESSAGE key are locked (For T20P, the MENU key is locked).</p> <p><b>Function Keys:</b> MESSAGE, RD, CONF, HOLD, MUTE, TRAN, OK, X, navigation keys, soft keys, line keys and memory keys are locked (For T22P, CONF, HOLD, MUTE and memory keys do not exist; For T20P, the MUTE key, soft keys and memory keys do not exist, but the additional MENU and Directory keys are locked).</p> <p><b>All Keys:</b> All keys are locked except the volume key.</p> <p>If set to 0 (Disabled), IP phone lock feature is disabled.</p> <p><b>Note:</b> It is applicable to SIP-T28P, T26P, T22P and T20P IP phones.</p>
<b>Format</b>	Integer
<b>Default Value</b>	0
<b>Range</b>	<p><b>Valid values are:</b></p> <p><b>0</b>-Disabled  <b>1</b>-Menu Key  <b>2</b>-Function Keys  <b>3</b>-All Keys</p>
<b>Example</b>	phone_setting.lock = 2

<b>Parameter-</b> phone_setting.phone_lock_enable	<b>Configuration File</b> <y0000000000xx>.cfg
<b>Description</b>	Enables or disables phone lock feature. <b>Note:</b> It is applicable to SIP-T19P and SIP-T21P IP phones.
<b>Format</b>	B
<b>Default Value</b>	0
<b>Range</b>	<b>Valid values are:</b> 0-Disabled 1-Enabled
<b>Example</b>	phone_setting.phone_lock_enable = 1

<b>Parameter-</b> phone_setting.phone_lock.lock_key_type	<b>Configuration File</b> <y0000000000xx>.cfg
<b>Description</b>	Specifies the type of phone lock. <b>Menu Key:</b> The Menu soft key is locked. <b>Function Keys:</b> MESSAGE, RD, TRAN, OK, X, navigation keys, soft keys and line keys are locked (For T19P, OK, X and line keys do not exist, but the additional √ and Mute keys are locked). <b>All Keys:</b> All keys are locked except the volume key. You are only allowed to dial emergency numbers, reject incoming calls by pressing the X key (not applicable to T19), answer incoming calls by lifting the handset, pressing the Speakerphone key, the HEADSET key or the OK key, mute an active call by pressing the X key (not applicable to T19), place an active call on hold by pressing the Hold soft key, resume the held call by pressing the Resume soft key, and end the call by hanging up the handset or pressing the Speakerphone key. <b>Note:</b> It is applicable to SIP-T19P and SIP-T21P IP phones.
<b>Format</b>	Integer

<b>Default Value</b>	Not Applicable
<b>Range</b>	<b>Valid values are:</b> 1-Menu Key 2-Function Keys 3-All Keys
<b>Example</b>	phone_setting.phone_lock.lock_key_type = 2

<b>Parameter-</b> phone_setting.phone_lock.unlock_pin	<b>Configuration File</b> <y0000000000xx>.cfg
<b>Description</b>	Sets a new unlock PIN. Once the IP phone is locked, you can use the default PIN "123" to unlock it.
<b>Format</b>	Not Applicable
<b>Default Value</b>	123
<b>Range</b>	0 to 15 characters
<b>Example</b>	phone_setting.phone_lock.unlock_pin = 123456

<b>Parameter-</b> phone_setting.phone_lock.lock_time_out	<b>Configuration File</b> <y0000000000xx>.cfg
<b>Description</b>	Configures the IP phone to automatically lock the keypad after a delay time (in seconds). If set to 0 (0s), the keypad will not be locked automatically. In this case, you can long press the pound key to lock the keypad only. <b>Note:</b> This parameter works only if the IP phone lock type is preset.
<b>Format</b>	Integer
<b>Default Value</b>	0
<b>Range</b>	0 to 3600
<b>Example</b>	phone_setting.phone_lock.lock_time_out = 8

## Time and Date

### NTP Server

Parameter-	Configuration File
local_time.manual_time_enable	<y0000000000xx>.cfg
<b>Description</b>	Configures the phone to obtain time from NTP server or manual settings. <b>Note:</b> It is only applicable to SIP-T19P and SIP-T21P IP phones.
<b>Format</b>	Integer
<b>Default Value</b>	0
<b>Range</b>	<b>Valid values are:</b> 0-NTP 1-Manual
<b>Example</b>	local_time.manual_time_enable = 1

Parameter-	Configuration File
local_time.ntp_server1	<y0000000000xx>.cfg
<b>Description</b>	Sets the IP address or the domain name of the primary NTP server.
<b>Format</b>	IP Address or Domain Name
<b>Default Value</b>	cn.pool.ntp.org
<b>Range</b>	Not Applicable
<b>Example</b>	local_time.ntp_server1 = 192.168.0.5

Parameter-	Configuration File
local_time.ntp_server2	<y0000000000xx>.cfg
<b>Description</b>	Sets the IP address or the domain name of the secondary NTP server. If the primary NTP server is not configured or cannot be accessed, the IP phone will request the time and date from the secondary NTP server.
<b>Format</b>	IP Address or Domain Name
<b>Default Value</b>	cn.pool.ntp.org

<b>Range</b>	Not Applicable
<b>Example</b>	local_time.ntp_server2 = 192.168.0.6

<b>Parameter-</b>	<b>Configuration File</b>
local_time.interval	<y0000000000xx>.cfg
<b>Description</b>	Sets the IP phone to update time and date from the NTP server at regular intervals (in seconds).
<b>Format</b>	Integer
<b>Default Value</b>	1000
<b>Range</b>	15 to 86400
<b>Example</b>	local_time.interval = 1200

### Time Zone

<b>Parameter-</b>	<b>Configuration File</b>
local_time.time_zone	<y0000000000xx>.cfg
<b>Description</b>	Defines the time zone. For more available time zone list, refer to <a href="#">Appendix B: Time Zones</a> on page 243.
<b>Format</b>	Not Applicable
<b>Default Value</b>	+8
<b>Range</b>	-11 to +13
<b>Example</b>	local_time.time_zone = +9

<b>Parameter-</b>	<b>Configuration File</b>
local_time.time_zone_name	<y0000000000xx>.cfg
<b>Description</b>	Defines the desired time zone name. For more available time zone name list, refer to <a href="#">Appendix B: Time Zones</a> on page 243.
<b>Format</b>	String
<b>Default Value</b>	China(Beijing)
<b>Range</b>	0 to 32 characters
<b>Example</b>	local_time.time_zone_name = Korea(Seoul)

## DST

Parameter-	Configuration File
local_time.summer_time	<y0000000000xx>.cfg
<b>Description</b>	Enables or disables the use of Daylight Saving Time (DST).
<b>Format</b>	Integer
<b>Default Value</b>	2
<b>Range</b>	<b>Valid values are:</b> 0-Disabled 1-Enabled 2-Automatic
<b>Example</b>	local_time.summer_time = 2

Parameter-	Configuration File
local_time.dst_time_type	<y0000000000xx>.cfg
<b>Description</b>	Configures the DST type. <b>Note:</b> It works only if the parameter "local_time.summer_time" is set to 1 (Enabled).
<b>Format</b>	Integer
<b>Default Value</b>	0
<b>Range</b>	<b>Valid values are:</b> 0-By Date 1-By Week
<b>Example</b>	local_time.dst_time_type = 1

Parameter-	Configuration File
local_time.start_time	<y0000000000xx>.cfg
<b>Description</b>	Specifies the time to start DST. If "local_time.dst_time_type" is set to 0 (By Date), use the mapping: MM: 1=Jan, 2=Feb,..., 12=Dec DD:1=the first day in a month,..., 31= the last day in a month HH:0=1am, 1=2am,..., 23=12pm

	<p>If "local_time.dst_time_type" is set to 1 (By Week), use the mapping:</p> <p>Month: 1=Jan, 2=Feb,..., 12=Dec</p> <p>Week of Month: 1=the first week in a month,..., 5=the last week in a month</p> <p>Day of Week: 1=Mon, 2=Tues,..., 7=Sun</p> <p>Hour of Day: 0=1am, 1=2am,..., 23=12pm</p> <p><b>Note:</b> It works only if the parameter "local_time.summer_time" is set to 1 (Enabled).</p>
<b>Format</b>	<p><b>The value formats are:</b></p> <ul style="list-style-type: none"> <li>• MM/DD/HH (For By Date)</li> <li>• Month/Week of Month/Day of Week/Hour of Day (For By Week)</li> </ul>
<b>Default Value</b>	1/1/0
<b>Range</b>	1to 12/1 to 31/0 to 23 (for By Date) 1 to 12/1 to 5/1 to 7/0 to 23 (for By Week)
<b>Example</b>	local_time.start_time = 5/20/12

<b>Parameter-</b>	<b>Configuration File</b>
local_time.end_time	<y0000000000xx>.cfg
<b>Description</b>	<p>Specifies the time to end DST.</p> <p>If "local_time.dst_time_type" is set to 0 (By Date), use the mapping:</p> <p>MM: 1=Jan, 2=Feb,..., 12=Dec</p> <p>DD:1=the first day in a month,..., 31= the last day in a month</p> <p>HH:0=1am, 1=2am,..., 23=12pm</p> <p>If "local_time.dst_time_type" is set to 1 (By Week), use the mapping:</p> <p>Month: 1=Jan, 2=Feb,..., 12=Dec</p> <p>Week of Month: 1=the first week in a month,..., 5=the last week in a month</p> <p>Day of Week: 1=Mon, 2=Tues,..., 7=Sun</p> <p>Hour of Day: 0=1am, 1=2am,..., 23=12pm</p> <p><b>Note:</b> It works only if the parameter "local_time.summer_time" is set to 1 (Enabled).</p>

<b>Format</b>	<p><b>The value formats are:</b></p> <ul style="list-style-type: none"> <li>• MM/DD/HH (For By Date)</li> <li>• Month/Week of Month/Day of Week/Hour of Day (For By Week)</li> </ul>
<b>Default Value</b>	12/31/23
<b>Range</b>	1 to 12/1 to 31/0 to 23 (For By Date) 1 to 12/1 to 5/1 to 7/0 to 23 (For By Week)
<b>Example</b>	local_time.end_time = 10/25/22

<b>Parameter-</b>	<b>Configuration File</b>
local_time.offset_time	<y0000000000xx>.cfg
<b>Description</b>	<p>Sets the offset time (in minutes) of DST.</p> <p><b>Note:</b> It works only if the parameter "local_time.summer_time" is set to 1 (Enabled).</p>
<b>Format</b>	Integer
<b>Default Value</b>	Blank
<b>Range</b>	-300 to +300
<b>Example</b>	local_time.offset_time = 120

**Time Format**

<b>Parameter-</b>	<b>Configuration File</b>
local_time.time_format	<y0000000000xx>.cfg
<b>Description</b>	<p>Sets the time format.</p> <p>If set to 0 (12 Hour), the time display uses 12 hour format.</p> <p>If set to 1 (24 Hour), the time display uses 24 hour format.</p>
<b>Format</b>	Integer
<b>Default Value</b>	1
<b>Range</b>	0-12 Hour 1-24 Hour
<b>Example</b>	local_time.time_format = 0



## Date Format

Parameter-	Configuration File
local_time.date_format	<y0000000000xx>.cfg
<b>Description</b>	Sets the date format. IP phones support various date formats. You can change the desired format according to your requirement.
<b>Format</b>	Integer
<b>Default Value</b>	0
<b>Range</b>	<b>Valid values are:</b> 0-WWW MMM DD 1-DD-MMM-YY 2-YYYY-MM-DD 3-DD/MM/YYYY 4-MM/DD/YY 5-DD MMM YYYY 6-WWW DD MMM
<b>Example</b>	local_time.date_format = 1

## Language

Parameter-	Configuration File
gui_lang.url	<y0000000000xx>.cfg
<b>Description</b>	Specifies the access URL of the language pack. <b>Note:</b> The language packs you load are dependent on available language packs from the provisioning server. You can download the language pack to the phone user interface only.
<b>Format</b>	URL
<b>Default Value</b>	Blank
<b>Range</b>	Not Applicable
<b>Example</b>	The following example uses HTTP to download the language pack "lang-Italian.txt" (Italian) from the provisioning server 192.168.10.25.

	gui_lang.url = http://192.168.10.25/lang-Italian.txt
--	---

Parameter-	Configuration File
lang.gui	<y0000000000xx>.cfg
<b>Description</b>	Specifies the language used on the phone user interface.
<b>Format</b>	String
<b>Default Value</b>	English
<b>Range</b>	<p><b>Valid values are:</b></p> <p>English</p> <p>Chinese_S (only applicable to SIP-T19P and SIP-T21P IP phones)</p> <p>Chinese_T (only applicable to SIP-T19P and SIP-T21P IP phones)</p> <p>German</p> <p>French</p> <p>Italian</p> <p>Portuguese</p> <p>Polish</p> <p>Spanish</p> <p>Turkish</p>
<b>Example</b>	lang.gui = Italian

Parameter-	Configuration File
lang.wui	<y0000000000xx>.cfg
<b>Description</b>	<p>Specifies the language used on the web user interface.</p> <p><b>Note:</b> The default language used on the web user interface depends on the language preferences of your browser. If the language of your browser is not supported by the IP phone, the web user interface will use English by default.</p>
<b>Format</b>	String
<b>Default Value</b>	Not Applicable
<b>Range</b>	<p><b>Valid values are:</b></p> <p>English</p>

	<p>Chinese_S (only applicable to SIP-T19P and SIP-T21P IP phones)</p> <p>German</p> <p>French (not applicable to SIP-T19P and SIP-T21P IP phones)</p> <p>Italian</p> <p>Portuguese (not applicable to SIP-T19P and SIP-T21P IP phones)</p> <p>Spanish (not applicable to SIP-T19P and SIP-T21P IP phones)</p> <p>Turkish</p>
<b>Example</b>	lang.wui = French

## Logo Customization

Parameter-	Configuration File
phone_setting.lcd_logo.mode	<y0000000000xx>.cfg
<b>Description</b>	<p>Configures the logo mode of the LCD screen.</p> <p>If set to 0 (Disabled), the IP phone is not allowed to display a logo.</p> <p>If set to 1 (System logo), the LCD screen will display the system logo.</p> <p>If set to 2 (Custom logo), the LCD screen will display the custom logo (you need to upload a custom logo file to the phone).</p> <p>For T20P IP phone: Enables or disables a text logo.</p>
<b>Format</b>	Integer
<b>Default Value</b>	<p>0</p> <p><b>Note:</b> For the SIP-T28P IP phone, the default value is 1.</p>
<b>Range</b>	<p><b>Valid values are:</b></p> <p>0-Disabled</p> <p>1-System logo</p> <p>2-Custom logo</p> <p><b>Note:</b> For the SIP-T28P IP phone, valid values are 1(System logo) and 2(Custom logo).</p> <p><b>For T20P IP Phone:</b></p> <p><b>Valid values are:</b></p>

	<b>0-Disabled</b> <b>1-Enabled</b>
<b>Example</b>	phone_setting.lcd_logo.mode = 1

Parameter-	Configuration File
lcd_logo.url	<y0000000000xx>.cfg
<b>Description</b>	Specifies the access URL of custom logo file. <b>Note:</b> It is not applicable to the SIP-T20P IP phone.
<b>Format</b>	String
<b>Default Value</b>	Blank
<b>Range</b>	Not Applicable
<b>Example</b>	The following example uses HTTP to download the custom logo file (logo.dob) from the provisioning server 192.168.10.25.  lcd_logo.url = http://192.168.10.25/logo.dob

Parameter-	Configuration File
phone_setting.lcd_logo.text	<y0000000000xx>.cfg
<b>Description</b>	Configures a text logo. <b>Note:</b> It is only applicable to the SIP-T20P IP phone.
<b>Format</b>	String
<b>Default Value</b>	Yealink
<b>Range</b>	0 to 15 characters
<b>Example</b>	phone_setting.lcd_logo.text = Yealink

## Key as Send

Parameter-	Configuration File
features.pound_key.mode	<y0000000000xx>.cfg
<b>Description</b>	Defines the "#" or "*" key as the send key. If set to 0 (Disabled), neither "#" nor "*" can be used as a send key. If set to 1(# key), the pound key is used as the

	send key. If set to 2(* key), the asterisk key is used as the send key.
<b>Format</b>	Integer
<b>Default Value</b>	1
<b>Range</b>	<b>Valid values are:</b> 0-Disabled 1-# key 2-* key
<b>Example</b>	features.pound_key.mode = 0

<b>Parameter-</b>	<b>Configuration File</b>
features.send_key_tone	<y0000000000xx>.cfg
<b>Description</b>	Enables or disables the IP phone to play a tone when a user presses a send key. If set to 1 (Enabled), the IP phone plays a tone when a user presses a send key. <b>Note:</b> It works only if the key tone is enabled. So you should set the parameter "features.key_tone" to 1 (Enabled) in advance.
<b>Format</b>	Integer
<b>Default Value</b>	1
<b>Range</b>	0-Disabled 1-Enabled
<b>Example</b>	features.send_key_tone = 0

## Hotline

<b>Parameter-</b>	<b>Configuration File</b>
features.hotline_number	<y0000000000xx>.cfg
<b>Description</b>	Configures the hotline number. It specifies a number that the IP phone automatically dials out when lifting the handset, pressing the speakerphone key or the line key. Leaving it blank disables hotline feature.

<b>Format</b>	String
<b>Default Value</b>	Blank
<b>Range</b>	0 to 32 characters
<b>Example</b>	features.hotline_number = 3601

<b>Parameter-</b>	<b>Configuration File</b>
features.hotline_delay	<y0000000000xx>.cfg
<b>Description</b>	<p>Specifies the waiting time (in seconds) the IP phone automatically dials out the hotline number.</p> <p>If set to 0 (0s), the IP phone immediately dials out the predefined hotline number when you lift the handset, press the speakerphone key or press the line key.</p> <p>If set to a value greater than 0, the IP phone waits the specified seconds before dialing out the predefined hotline number when you lift the handset, press the speakerphone key or press the line key.</p>
<b>Format</b>	Integer
<b>Default Value</b>	4
<b>Range</b>	0 to 10
<b>Example</b>	features.hotline_delay = 30

## Call Log

<b>Parameter-</b>	<b>Configuration File</b>
features.save_call_history	<y0000000000xx>.cfg
<b>Description</b>	<p>Enables or disables the IP phone to save call log.</p> <p>If set to 0 (Disabled), the IP phone cannot log the placed calls, received calls, missed calls and the forwarded calls in the call log lists.</p>
<b>Format</b>	Boolean
<b>Default Value</b>	1
<b>Range</b>	<p>0-Disabled</p> <p>1-Enabled</p>

<b>Example</b>	features.save_call_history = 0
----------------	--------------------------------

## Missed Call Log

Parameter-	Configuration File
account.x.missed_calllog	<MAC>.cfg
<b>Description</b>	<p>Enables or disables missed call log feature for account x.</p> <p>If set to 0 (Disabled), there is no indicator displaying on the LCD screen, the IP phone does not log the missed call in the Missed Calls list.</p> <p>If set to 1 (Enabled), a prompt message "&lt;number&gt; New Missed Call(s)" along with an indicator icon is displayed on the IP phone idle screen when the IP phone misses calls.</p> <p>X ranges from 1 to 6.</p>
<b>Format</b>	Boolean
<b>Default Value</b>	1
<b>Range</b>	0-Disabled 1-Enabled
<b>Example</b>	account.1.missed_calllog = 1

## Live Dialpad

Parameter-	Configuration File
phone_setting.predial_autodial	<y0000000000xx>.cfg
<b>Description</b>	<p>Configures live dialpad feature.</p> <p>If set to 1 (Enabled), the IP phone automatically dials out the entered phone number without having to press any key.</p>
<b>Format</b>	Boolean
<b>Default Value</b>	0
<b>Range</b>	0-Disabled 1-Enabled
<b>Example</b>	phone_setting.predial_autodial = 1

Parameter-	Configuration File
phone_setting.inter_digit_time	<y0000000000xx>.cfg
Description	Configures the time (in seconds) for the phone to automatically dial out the entered digits without pressing any other key. <b>Note:</b> It works only if the parameter "phone_setting.predial_autodial" is set to 1 (Enabled).
Format	Integer
Default Value	4
Range	1 to 14
Example	phone_setting.inter_digit_time = 1

## Call Waiting

Parameter-	Configuration File
call_waiting.enable	<y0000000000xx>.cfg
Description	Enables or disables call waiting feature. If set to 0 (Disabled), a new incoming call is automatically rejected by the IP phone with a busy message while during a call. If set to 1 (Enabled), the LCD screen presents a new incoming call while during a call.
Format	Boolean
Default Value	1
Range	0-Disabled 1-Enabled
Example	call_waiting.enable = 1

Parameter-	Configuration File
call_waiting.tone	<y0000000000xx>.cfg
Description	Enables or disables the playing of a call waiting tone when the IP phone receives an incoming call during a call. If set to 1 (Enabled), the IP phone performs an audible indicator when receiving a new incoming call during a call.



	<b>Note:</b> It works only if the parameter "call_waiting.enable" is set to 1 (Enabled).
<b>Format</b>	Boolean
<b>Default Value</b>	1
<b>Range</b>	0-Disabled 1-Enabled
<b>Example</b>	call_waiting.tone = 1

<b>Parameter-</b> call_waiting.on_code	<b>Configuration File</b> <y0000000000xx>.cfg
<b>Description</b>	Sets the call waiting on code to activate the server-side call waiting feature (optional).
<b>Format</b>	String
<b>Default Value</b>	Blank
<b>Range</b>	0 to 32 characters
<b>Example</b>	call_waiting.on_code = *72

<b>Parameter-</b> call_waiting.off_code	<b>Configuration File</b> <y0000000000xx>.cfg
<b>Description</b>	Sets the call waiting off code to deactivate the server-side call waiting feature (optional).
<b>Format</b>	String
<b>Default Value</b>	Blank
<b>Range</b>	0 to 32 characters
<b>Example</b>	call_waiting.off_code = *73

## Auto Redial

<b>Parameter-</b> auto_redial.enable	<b>Configuration File</b> <y0000000000xx>.cfg
<b>Description</b>	Enables or disables the IP phone to automatically redial the called number when it is busy.  If set to 1 (Enabled), the IP phone dials the previous dialed out number automatically

	when the dialed number is busy.
<b>Format</b>	Boolean
<b>Default Value</b>	0
<b>Range</b>	0-Disabled 1-Enabled
<b>Example</b>	auto_redial.enable = 1

Parameter-	Configuration File
auto_redial.interval	<y0000000000xx>.cfg
<b>Description</b>	Sets the interval (in seconds) for the IP phone to wait between redials. The IP phone redials the dialed number at regular intervals till the callee answers the call.
<b>Format</b>	Integer
<b>Default Value</b>	10
<b>Range</b>	1 to 300
<b>Example</b>	auto_redial.interval = 30

Parameter-	Configuration File
auto_redial.times	<y0000000000xx>.cfg
<b>Description</b>	Sets the redial times for the IP phone. The IP phone tries to redial the dialed number as many times as configured till the callee answers the call.
<b>Format</b>	Integer
<b>Default Value</b>	10
<b>Range</b>	1 to 300
<b>Example</b>	auto_redial.times = 8

## Auto Answer

Parameter-	Configuration File
account.x.auto_answer	<MAC>.cfg

<b>Description</b>	<p>Enables or disables auto answer feature for account x.</p> <p>If set to 1 (Enabled), the IP phone can automatically answer an incoming call.</p> <p>X ranges from 1 to 6.</p> <p><b>Note:</b> The IP phone cannot automatically answer the incoming call during a call even if auto answer is enabled.</p>
<b>Format</b>	Boolean
<b>Default Value</b>	0
<b>Range</b>	<p>0-Disabled</p> <p>1-Enabled</p>
<b>Example</b>	account.1.auto_answer = 1

## Call Completion

Parameter-	Configuration File
features.call_completion_enable	<y0000000000xx>.cfg
<b>Description</b>	<p>Enables or disables call completion feature.</p> <p>If a user places a call and the callee is temporarily not available to answer the call, call completion feature allows notifying the user when the callee becomes available to receive a call.</p> <p>If set to 1 (Enabled), the caller is notified when the callee becomes available to receive a call.</p>
<b>Format</b>	Boolean
<b>Default Value</b>	0
<b>Range</b>	<p>0-Disabled</p> <p>1-Enabled</p>
<b>Example</b>	features.call_completion_enable = 1

## Anonymous Call

Parameter-	Configuration File
account.x.anonymous_call	<MAC>.cfg

<b>Description</b>	<p>Enables or disables anonymous call feature for account x.</p> <p>If set to 1 (Enabled), the IP phone blocks its identity from showing up to the callee when placing a call. The callee's phone LCD screen presents anonymous instead of the caller's identity.</p> <p>X ranges from 1 to 6.</p>
<b>Format</b>	Boolean
<b>Default Value</b>	0
<b>Range</b>	<p>0-Disabled</p> <p>1-Enabled</p>
<b>Example</b>	account.1.anonymous_call = 1

<b>Parameter-</b> account.x.anonymous_call_oncode	<b>Configuration File</b> <MAC>.cfg
<b>Description</b>	<p>Sets the anonymous call on code to activate the server-side anonymous call feature for account x (optional).</p> <p>X ranges from 1 to 6.</p>
<b>Format</b>	String
<b>Default Value</b>	Blank
<b>Range</b>	0 to 32 characters
<b>Example</b>	account.1.anonymous_call_oncode = *72

<b>Parameter-</b> account.x.anonymous_call_offcode	<b>Configuration File</b> <MAC>.cfg
<b>Description</b>	<p>Sets the anonymous call off code to deactivate the server-side anonymous call feature for account x (optional).</p> <p>X ranges from 1 to 6.</p>
<b>Format</b>	String
<b>Default Value</b>	Blank
<b>Range</b>	0 to 32 characters

<b>Example</b>	account.1.anonymous_call_offcode = *73
----------------	--

## Anonymous Call Rejection

<b>Parameter-</b>	<b>Configuration File</b>
account.x.reject_anonymous_call	<MAC>.cfg
<b>Description</b>	<p>Enables or disables anonymous call rejection feature for account x.</p> <p>If set to 1 (Enabled), the IP phone automatically rejects incoming calls from users enabled anonymous call feature. The anonymous user's phone LCD screen presents "Anonymity Disallowed".</p> <p>X ranges from 1 to 6.</p>
<b>Format</b>	Boolean
<b>Default Value</b>	0
<b>Range</b>	0-Disabled 1-Enabled
<b>Example</b>	account.1.reject_anonymous_call = 1

<b>Parameter-</b>	<b>Configuration File</b>
account.x.anonymous_reject_oncode	<MAC>.cfg
<b>Description</b>	<p>Sets the anonymous call rejection on code to activate the server-side anonymous call rejection feature for account x (optional).</p> <p>X ranges from 1 to 6.</p>
<b>Format</b>	String
<b>Default Value</b>	Blank
<b>Range</b>	0 to 32 characters
<b>Example</b>	account.1.anonymous_reject_oncode = *74

<b>Parameter-</b>	<b>Configuration File</b>
account.x.anonymous_reject_of	<MAC>.cfg

<b>fcode</b>	
<b>Description</b>	Sets the anonymous call rejection off code to deactivate the server-side anonymous call rejection feature for account x (optional). X ranges from 1 to 6.
<b>Format</b>	String
<b>Default Value</b>	Blank
<b>Range</b>	0 to 32 characters
<b>Example</b>	account.1.anonymous_reject_offcode = *73

## Do Not Disturb

### Return Message When DND

<b>Parameter-</b>	<b>Configuration File</b>
features.dnd_refuse_code	<y0000000000xx>.cfg
<b>Description</b>	Defines return codes and reason of the SIP response message when rejecting an incoming call for DND. A specific reason is displayed on the caller's phone LCD screen. If set to 486 (Busy here), the caller's phone LCD screen displays the reason "Busy here" when the callee enables DND feature.
<b>Format</b>	Integer
<b>Default Value</b>	480
<b>Range</b>	<b>Valid values are:</b> <b>404</b> -No Found <b>480</b> -Temporarily not available <b>486</b> -Busy here
<b>Example</b>	features.dnd_refuse_code = 486

## DND Mode

Parameter-	Configuration File
features.dnd_mode	<y0000000000xx>.cfg
<b>Description</b>	Sets the DND mode for the IP phone. If set to 0 (Phone), DND feature is effective for the IP phone. If set to 1 (Custom), you can configure DND feature for each account.
<b>Format</b>	Integer
<b>Default Value</b>	0
<b>Range</b>	0-Phone 1-Custom
<b>Example</b>	features.dnd_mode = 0

## DND in Phone Mode

Parameter-	Configuration File
features.dnd.enable	<y0000000000xx>.cfg
<b>Description</b>	Enables or disables DND feature. If set to 1 (Enabled), the IP phone rejects incoming calls on all accounts.
<b>Format</b>	Boolean
<b>Default Value</b>	0
<b>Range</b>	0-Disabled 1-Enabled
<b>Example</b>	features.dnd.enable = 1

Parameter-	Configuration File
features.dnd.on_code	<y0000000000xx>.cfg
<b>Description</b>	Sets the DND on code to activate the server-side DND feature.
<b>Format</b>	String
<b>Default Value</b>	Blank
<b>Range</b>	0 to 32 characters
<b>Example</b>	features.dnd.on_code = *71

Parameter-	Configuration File
features.dnd.off_code	<y0000000000xx>.cfg
<b>Description</b>	Sets the DND off code to deactivate the server-side DND feature.
<b>Format</b>	String
<b>Default Value</b>	Blank
<b>Range</b>	0 to 32 characters
<b>Example</b>	features.dnd.off_code = *72

### DND in Custom Mode

Parameter-	Configuration File
account.x.dnd.enable	<MAC>.cfg
<b>Description</b>	Enables or disables DND feature for account x. If set to 1 (Enabled), the IP phone rejects incoming calls on account x. X ranges from 1 to 6.
<b>Format</b>	Boolean
<b>Default Value</b>	0
<b>Range</b>	0-Disabled 1-Enabled
<b>Example</b>	account.1.dnd.enable = 1

Parameter-	Configuration File
account.x.dnd.on_code	<MAC>.cfg
<b>Description</b>	Sets the DND on code to activate the server-side DND feature for account x (optional). X ranges from 1 to 6.
<b>Format</b>	String
<b>Default Value</b>	Blank
<b>Range</b>	0 to 32 characters
<b>Example</b>	account.1.dnd.on_code = *73



Parameter-	Configuration File
account.x.dnd.off_code	<MAC>.cfg
<b>Description</b>	Sets the DND off code to deactivate the server-side DND feature for account x (optional). X ranges from 1 to 6.
<b>Format</b>	String
<b>Default Value</b>	Blank
<b>Range</b>	0 to 32 characters
<b>Example</b>	account.1.dnd.off_code = *74

### Busy Tone Delay

Parameter-	Configuration File
features.busy_tone_delay	<y0000000000xx>.cfg
<b>Description</b>	Configures a period of time (in seconds) for which the busy tone is audible on the IP phone. When one party releases the call, a busy tone is audible to the other party indicating that the call connection breaks. If set to 3 (3s), a busy tone is audible for 3 seconds on the IP phone.
<b>Format</b>	Integer
<b>Default Value</b>	0
<b>Range</b>	<b>Valid values are:</b> 0-0s 3-3s 5-5s
<b>Example</b>	features.busy_tone_delay = 3

### Return Code When Refuse

Parameter-	Configuration File
features.normal_refuse_code	<y0000000000xx>.cfg
<b>Description</b>	Defines return codes and messages when rejecting an incoming call. A specific return

	<p>message is displayed on the caller's phone LCD screen.</p> <p>If set to 486 (Busy here), the caller's phone LCD screen displays the message "Busy here" when the callee rejects the incoming call.</p>
<b>Format</b>	Integer
<b>Default Value</b>	486
<b>Range</b>	<p><b>Valid values are:</b></p> <p><b>404</b>-No Found</p> <p><b>480</b>-Temporarily not available</p> <p><b>486</b>-Busy here</p>
<b>Example</b>	features.normal_refuse_code = 480

### 180 Ring Workaround

<b>Parameter-</b>	<b>Configuration File</b>
phone_setting.is_deal180	<y0000000000xx>.cfg
<b>Description</b>	<p>Enables or disables the IP phone to deal with the 180 SIP message received after the 183 SIP message.</p> <p>If set to 1 (Enabled), the IP phone resumes and plays the local ringback tone upon a subsequent 180 message received.</p>
<b>Format</b>	Boolean
<b>Default Value</b>	1
<b>Range</b>	<p><b>0</b>-Disabled</p> <p><b>1</b>-Enabled</p>
<b>Example</b>	phone_setting.is_deal180 = 0

### Use Outbound Proxy in Dialog

<b>Parameter-</b>	<b>Configuration File</b>
sip.use_out_bound_in_dialog	<y0000000000xx>.cfg
<b>Description</b>	<p>Enables or disables the IP phone to send the SIP messages to the outbound proxy server.</p> <p>If set to 1 (Enabled), all the SIP request</p>

	messages from the IP phone will be forced to send to the outbound proxy server.
<b>Format</b>	Boolean
<b>Default Value</b>	1
<b>Range</b>	0-Disabled 1-Enabled
<b>Example</b>	sip.use_out_bound_in_dialog = 0

## SIP Session Timer

<b>Parameter-</b>	<b>Configuration File</b>
account.x.advanced.timer_t1	<MAC>.cfg
<b>Description</b>	Configures the SIP session timer T1 (in seconds) for account x. T1 is an estimate of the Round Trip Time (RTT) of transactions between a SIP client and SIP server. X ranges from 1 to 6.
<b>Format</b>	Float
<b>Default Value</b>	0.5
<b>Range</b>	0.5 to 10
<b>Example</b>	account.1.advanced.timer_t1 = 1

<b>Parameter-</b>	<b>Configuration File</b>
account.x.advanced.timer_t2	<MAC>.cfg
<b>Description</b>	Configures the session timer T2 (in seconds) for account x. T2 represents the maximum retransmitting time of any SIP request message. The re-transmitting and doubling of T1 continues until the retransmitting time reaches the T2 value. X ranges from 1 to 6.
<b>Format</b>	Float
<b>Default Value</b>	4

<b>Range</b>	2 to 40
<b>Example</b>	account.1.advanced.timer_t2 = 5

<b>Parameter-</b> account.x.advanced.timer_t4	<b>Configuration File</b> <MAC>.cfg
<b>Description</b>	Configures the session timer of T4 (in seconds) for account x.  T4 represents the time the network will take to clear messages between the SIP Client and SIP Server.  X ranges from 1 to 6.
<b>Format</b>	Float
<b>Default Value</b>	5
<b>Range</b>	2.5 to 60
<b>Example</b>	account.1.advanced.timer_t4 = 10

## Session Timer

<b>Parameter-</b> account.x.session_timer.enable	<b>Configuration File</b> <MAC>.cfg
<b>Description</b>	Enables or disables the session timer for account x.  If set to 1 (Enabled), IP phone sends periodic re-INVITE requests to refresh the session during a call.  X ranges from 1 to 6.
<b>Format</b>	Boolean
<b>Default Value</b>	0
<b>Range</b>	0-Disabled 1-Enabled
<b>Example</b>	account.1.session_timer.enable = 1

<b>Parameter-</b> account.x.session_timer.expires	<b>Configuration File</b> <MAC>.cfg
<b>Description</b>	Configures the IP phone to refresh the session

	<p>during a call at regular intervals (in seconds) for account x.</p> <p>If set to 1800 (1800s), the IP phone refreshes the session during a call before 1800 seconds.</p> <p>X ranges from 1 to 6.</p>
<b>Format</b>	Integer
<b>Default Value</b>	1800
<b>Range</b>	1-9999
<b>Example</b>	account.1.session_timer.expires = 300

<b>Parameter-</b>	<b>Configuration File</b>
account.x.session_timer.refresher	<MAC>.cfg
<b>Description</b>	<p>Configures the session timer refresher for account x.</p> <p>If set to 0 (UAC), refreshing the session is performed by the IP phone.</p> <p>If set to 1 (UAS), refreshing the session is performed by a SIP server.</p> <p>X ranges from 1 to 6.</p>
<b>Format</b>	Integer
<b>Default Value</b>	0
<b>Range</b>	<p><b>Valid values are:</b></p> <p>0-UAC</p> <p>1-UAS</p>
<b>Example</b>	account.1.session_timer.refresher = 1

## Call Hold

<b>Parameter-</b>	<b>Configuration File</b>
features.play_hold_tone.enable	<y0000000000xx>.cfg
<b>Description</b>	Enables or disables the IP phone to play a tone when there is a hold call on the IP phone.
<b>Format</b>	Boolean
<b>Default Value</b>	1

<b>Range</b>	0-Disabled 1-Enabled
<b>Example</b>	features.play_hold_tone.enable = 1

<b>Parameter-</b>	<b>Configuration File</b>
features.play_hold_tone.delay	<y0000000000xx>.cfg
<b>Description</b>	<p>Specifies the interval (in seconds) at which the IP phone plays a hold tone.</p> <p>If set to 30 (30s), the IP phone plays a hold tone every 30 seconds when there is a hold call on the IP phone.</p> <p><b>Note:</b> It works only if the parameter "features.play_hold_tone.enable" is set to 1 (Enabled).</p>
<b>Format</b>	Integer
<b>Default Value</b>	30
<b>Range</b>	Not Applicable
<b>Example</b>	features.play_hold_tone.delay = 60

<b>Parameter-</b>	<b>Configuration File</b>
sip.rfc2543_hold	<y0000000000xx>.cfg
<b>Description</b>	<p>Specifies whether RFC 2543 (c=0.0.0.0) outgoing hold signaling is used.</p> <p>If set to 0 (Disabled), use SDP media direction attributes (such as a=sendonly) per RFC 3264 when putting a call on hold.</p> <p>If set to 1 (Enabled), use SDP media connection address c=0.0.0.0 per RFC 2543 when putting a call on hold.</p>
<b>Format</b>	Boolean
<b>Default Value</b>	0
<b>Range</b>	0-Disabled 1-Enabled
<b>Example</b>	sip.rfc2543_hold = 1

## Call Forward

### Call Forward Mode

Parameter-	Configuration File
features.fwd_mode	<y0000000000xx>.cfg
Description	Sets the call forward mode for the IP phone. If set to 0 (Phone), call forward feature is effective for the IP phone. If set to 1 (Custom), you can configure call forward feature for each account.
Format	Integer
Default Value	0
Range	0-Phone 1-Custom
Example	features.fwd_mode = 0

### Call Forward in Phone Mode

#### Always Forward

Parameter-	Configuration File
forward.always.enable	< y0000000000xx >.cfg
Description	Enables or disables always forward feature. If set to 1 (Enabled), incoming call are forwarded to the destination number immediately.
Format	Boolean
Default Value	0
Range	0-Disabled 1-Enabled
Example	forward.always.enable = 1

Parameter-	Configuration File
forward.always.target	< y0000000000xx >.cfg
Description	Defines the destination number of the always forward.
Format	String

<b>Default Value</b>	Blank
<b>Range</b>	Not Applicable
<b>Example</b>	forward.always.target = 3601

<b>Parameter-</b> forward.always.on_code	<b>Configuration File</b> < y0000000000xx >.cfg
<b>Description</b>	Sets the always forward on code to activate the server-side always forward feature.
<b>Format</b>	String
<b>Default Value</b>	Blank
<b>Range</b>	Not Applicable
<b>Example</b>	forward.always.on_code = *72

<b>Parameter-</b> forward.always.off_code	<b>Configuration File</b> < y0000000000xx >.cfg
<b>Description</b>	Sets the always forward off code to deactivate the server-side always forward feature.
<b>Format</b>	String
<b>Default Value</b>	Blank
<b>Range</b>	Not Applicable
<b>Example</b>	forward.always.off_code = *73

### Busy Forward

<b>Parameter-</b> forward.busy.enable	<b>Configuration File</b> < y0000000000xx >.cfg
<b>Description</b>	Enables or disables busy forward feature. If set to 1 (Enabled), incoming calls are forwarded to the destination number when the callee is busy.
<b>Format</b>	Boolean
<b>Default Value</b>	0
<b>Range</b>	0-Disabled 1-Enabled



<b>Example</b>	forward.busy.enable = 1
----------------	-------------------------

<b>Parameter-</b> forward.busy.target	<b>Configuration File</b> < y0000000000xx >.cfg
<b>Description</b>	Defines the destination number of the busy forward.
<b>Format</b>	String
<b>Default Value</b>	Blank
<b>Range</b>	Not Applicable
<b>Example</b>	forward.busy.target = 3602

<b>Parameter-</b> forward.busy.on_code	<b>Configuration File</b> < y0000000000xx >.cfg
<b>Description</b>	Sets the busy forward on code to activate the server-side busy forward feature.
<b>Format</b>	String
<b>Default Value</b>	Blank
<b>Range</b>	Not Applicable
<b>Example</b>	forward.busy.on_code = *74

<b>Parameter-</b> forward.busy.off_code	<b>Configuration File</b> < y0000000000xx >.cfg
<b>Description</b>	Sets the busy forward off code to deactivate the server-side busy forward feature.
<b>Format</b>	String
<b>Default Value</b>	Blank
<b>Range</b>	Not Applicable
<b>Example</b>	forward.busy.off_code = *75

### No Answer Forward

<b>Parameter-</b> forward.no_answer.enable	<b>Configuration File</b> < y0000000000xx >.cfg
<b>Description</b>	Enables or disables no answer forward

	feature. If set to 1 (Enabled), incoming calls are forward to the destination number after a period of ring time.
<b>Format</b>	Boolean
<b>Default Value</b>	0
<b>Range</b>	0-Disabled 1-Enabled
<b>Example</b>	forward.no_answer.enable = 1

<b>Parameter-</b> forward.no_answer.target	<b>Configuration File</b> < y0000000000xx >.cfg
<b>Description</b>	Defines the destination number of the no answer forward.
<b>Format</b>	String
<b>Default Value</b>	Blank
<b>Range</b>	Not Applicable
<b>Example</b>	forward.no_answer.target = 3603

<b>Parameter-</b> forward.no_answer.timeout	<b>Configuration File</b> < y0000000000xx >.cfg
<b>Description</b>	Defines a period of ring time to wait before forwarding the incoming call. The interval of the ring time is n*6 (0≤n≤20), the valid values ranges from 0 to 20.
<b>Format</b>	Integer
<b>Default Value</b>	2
<b>Range</b>	0 to 20
<b>Example</b>	forward.no_answer.timeout = 5

<b>Parameter-</b> forward.no_answer.on_code	<b>Configuration File</b> < y0000000000xx >.cfg
<b>Description</b>	Sets the no answer forward on code to activate the server-side no answer forward feature.

<b>Format</b>	String
<b>Default Value</b>	Blank
<b>Range</b>	Not Applicable
<b>Example</b>	forward.no_answer.on_code = *76

<b>Parameter-</b>	<b>Configuration File</b>
forward.no_answer.off_code	< y0000000000xx >.cfg
<b>Description</b>	Sets the no answer forward off code to deactivate the server-side no answer forward feature.
<b>Format</b>	String
<b>Default Value</b>	Blank
<b>Range</b>	Not Applicable
<b>Example</b>	forward.no_answer.off_code = *77

### Call Forward in Custom Mode

#### Always Forward

<b>Parameter-</b>	<b>Configuration File</b>
account.x.always_fwd.enable	<MAC>.cfg
<b>Description</b>	Enables or disables always forward feature for account x.  If set to 1 (Enabled), incoming calls to the account x are forwarded to the destination number immediately.  X ranges from 1 to 6.
<b>Format</b>	Boolean
<b>Default Value</b>	0
<b>Range</b>	0-Disabled 1-Enabled
<b>Example</b>	account.1.always_fwd.enable = 1

<b>Parameter-</b>	<b>Configuration File</b>
account.x.always_fwd.target	<MAC>.cfg
<b>Description</b>	Defines the destination number of the always forward for account x.

	X ranges from 1 to 6.
<b>Format</b>	String
<b>Default Value</b>	Blank
<b>Range</b>	0 to 32 characters
<b>Example</b>	account.1.always_fwd.target = 3601

<b>Parameter-</b> account.x.always_fwd.on_code	<b>Configuration File</b> <MAC>.cfg
<b>Description</b>	Sets the always forward on code activate the server-side always forward feature for account x. X ranges from 1 to 6.
<b>Format</b>	String
<b>Default Value</b>	Blank
<b>Range</b>	0 to 32 characters
<b>Example</b>	account.1.always_fwd.on_code = *72

<b>Parameter-</b> account.x.always_fwd.off_code	<b>Configuration File</b> <MAC>.cfg
<b>Description</b>	Sets the always forward off code to deactivate the server-side always forward feature for account x. X ranges from 1 to 6.
<b>Format</b>	String
<b>Default Value</b>	Blank
<b>Range</b>	0 to 32 characters
<b>Example</b>	account.1.busy_fwd.off_code = *73

### Busy Forward

<b>Parameter-</b> account.x.busy_fwd.enable	<b>Configuration File</b> <MAC>.cfg
<b>Description</b>	Enables or disables busy forward feature for account x. If set to 1 (Enabled), incoming calls to the

	account x are forwarded to the destination number when the callee is busy. X ranges from 1 to 6.
<b>Format</b>	Boolean
<b>Default Value</b>	0
<b>Range</b>	0-Disabled 1-Enabled
<b>Example</b>	account.1.busy_fwd.enable = 1

<b>Parameter-</b> account.x.busy_fwd.target	<b>Configuration File</b> <MAC>.cfg
<b>Description</b>	Defines the destination number of the busy forward for account x. X ranges from 1 to 6.
<b>Format</b>	String
<b>Default Value</b>	Blank
<b>Range</b>	0 to 32 characters
<b>Example</b>	account.1.busy_fwd.target = 3602

<b>Parameter-</b> account.x.busy_fwd.on_code	<b>Configuration File</b> <MAC>.cfg
<b>Description</b>	Sets the busy forward on code to activate the server-side busy forward feature for account x. X ranges from 1 to 6.
<b>Format</b>	String
<b>Default Value</b>	Blank
<b>Range</b>	0 to 32 characters
<b>Example</b>	account.1.busy_fwd.on_code = *74

<b>Parameter-</b> account.x.busy_fwd.off_code	<b>Configuration File</b> <MAC>.cfg
<b>Description</b>	Sets the busy forward off code to deactivate the server-side busy forward feature for

	account x (optional). X ranges from 1 to 6.
<b>Format</b>	String
<b>Default Value</b>	Blank
<b>Range</b>	0 to 32 characters
<b>Example</b>	account.1.busy_fwd.off_code = *75

### No Answer Forward

<b>Parameter-</b>	<b>Configuration File</b>
account.x.timeout_fwd.enable	<MAC>.cfg
<b>Description</b>	Enables or disables no answer forward feature for account x. If set to 1 (Enabled), incoming calls to the account x are forward to the destination number after a period of ring time. X ranges from 1 to 6.
<b>Format</b>	Boolean
<b>Default Value</b>	0
<b>Range</b>	0-Disabled 1-Enabled
<b>Example</b>	account.1.timeout_fwd.enable = 1

<b>Parameter-</b>	<b>Configuration File</b>
account.x.timeout_fwd.target	<MAC>.cfg
<b>Description</b>	Defines the destination number of the no answer forward for account x. X ranges from 1 to 6.
<b>Format</b>	String
<b>Default Value</b>	Blank
<b>Range</b>	0 to 32 characters
<b>Example</b>	account.1.timeout_fwd.target = 3603

Parameter-	Configuration File
account.x.timeout_fwd.timeout	<MAC>.cfg
<b>Description</b>	Defines a period of ring time to wait before forwarding the incoming call for account x. The interval of the ring time is $n*6$ ( $0 \leq n \leq 20$ ), the valid values ranges from 0 to 20. X ranges from 1 to 6.
<b>Format</b>	Integer
<b>Default Value</b>	2
<b>Range</b>	0 to 20
<b>Example</b>	account.1.timeout_fwd.timeout = 5

Parameter-	Configuration File
account.x.timeout_fwd.on_code	<MAC>.cfg
<b>Description</b>	Sets the no answer forward on code to activate the server-side no answer forward feature for account x. X ranges from 1 to 6.
<b>Format</b>	String
<b>Default Value</b>	Blank
<b>Range</b>	0 to 32 characters
<b>Example</b>	account.1.timeout_fwd.on_code = *76

Parameter-	Configuration File
account.x.timeout_fwd.off_code	<MAC>.cfg
<b>Description</b>	Sets the no answer forward off code to activate the server-side no answer forward feature for account x. X ranges from 1 to 6.
<b>Format</b>	String
<b>Default Value</b>	Blank
<b>Range</b>	0 to 32 characters
<b>Example</b>	account.1.timeout_fwd.off_code = *77

### Fwd International

Parameter-	Configuration File
forward.international.enable	<y0000000000xx>.cfg
<b>Description</b>	Enables or disables the IP phone to forward an incoming call to an international phone number (the prefix is 00).
<b>Format</b>	Boolean
<b>Default Value</b>	1
<b>Range</b>	0-Disabled 1-Enabled
<b>Example</b>	forward.international.enable = 1

### Call Transfer

Parameter-	Configuration File
transfer.blind_tran_on_hook_enable	<y0000000000xx>.cfg
<b>Description</b>	Enables or disables the IP phone to complete the blind transfer through on-hook.
<b>Format</b>	Boolean
<b>Default Value</b>	1
<b>Range</b>	0-Disabled 1-Enabled
<b>Example</b>	transfer.blind_tran_on_hook_enable = 1

Parameter-	Configuration File
transfer.on_hook_trans_enable	<y0000000000xx>.cfg
<b>Description</b>	Enables or disables the IP phone to complete the semi-attended transfer or the attended transfer through on-hook.
<b>Format</b>	Boolean
<b>Default Value</b>	1
<b>Range</b>	0-Disabled 1-Enabled
<b>Example</b>	transfer.on_hook_trans_enable = 1



Parameter-	Configuration File
transfer.semi_attend_tran_enable	<y0000000000xx>.cfg
<b>Description</b>	Specifies whether to display the missed call prompt on the destination party's phone.
<b>Format</b>	Boolean
<b>Default Value</b>	1
<b>Range</b>	0-Disabled 1-Enabled
<b>Example</b>	transfer.semi_attend_tran_enable = 1

## Network Conference

Parameter-	Configuration File
account.x.conf_type	<MAC>.cfg
<b>Description</b>	Defines the conference type for account x. If set to 0 (Local Conference), conferences are set up on the IP phone locally. If set to 2 (Network Conference), conferences are set up by the server. X ranges from 1 to 6.
<b>Format</b>	Integer
<b>Default Value</b>	0
<b>Range</b>	<b>Valid values are:</b> 0-Local Conference 2-Network Conference
<b>Example</b>	account.1.conf_type = 2

Parameter-	Configuration File
account.x.conf_uri	<MAC>.cfg
<b>Description</b>	Defines the conference URI for account x. X ranges from 1 to 6. <b>Note:</b> It works only if the parameter "account.x.conf_type" is set to 2 (Network Conference).
<b>Format</b>	String

<b>Default Value</b>	Blank
<b>Range</b>	0 to 511 characters
<b>Example</b>	account.1.conf_uri = conference@domain.com

## Transfer on Conference Hang Up

<b>Parameter-</b>	<b>Configuration File</b>
transfer.tran_others_after_conf_enable	<y0000000000xx>.cfg
<b>Description</b>	Enables or disables Transfer on Conference Hang Up feature.  If enabled, the other two parties remain connected when the conference initiator drops the conference call.  <b>Note:</b> It is only applicable to the local conference.
<b>Format</b>	Boolean
<b>Default Value</b>	0
<b>Range</b>	0-Disabled 1-Enabled
<b>Example</b>	transfer.tran_others_after_conf_enable = 1

## Directed Call Pickup

### Phone Basis

<b>Parameter-</b>	<b>Configuration File</b>
features.pickup.direct_pickup_enable	<y0000000000xx>.cfg
<b>Description</b>	Enables or disables the IP phone to display the DPickup soft key when the IP phone is off-hook.
<b>Format</b>	Boolean
<b>Default Value</b>	0
<b>Range</b>	0-Disabled 1-Enabled

<b>Example</b>	features.pickup.direct_pickup_enable = 1
----------------	--

<b>Parameter-</b>	<b>Configuration File</b>
features.pickup.direct_pickup_code	<y0000000000xx>.cfg
<b>Description</b>	Configures the directed call pickup code on a phone basis. <b>Note:</b> The directed call pickup code configured on a per-line basis takes precedence over that configured on a phone basis.
<b>Format</b>	String
<b>Default Value</b>	Blank
<b>Range</b>	Not Applicable
<b>Example</b>	features.pickup.direct_pickup_code = *97

### Per-line Basis

<b>Parameter-</b>	<b>Configuration File</b>
account.x.direct_pickup_code	<y0000000000xx>.cfg
<b>Description</b>	Configures the directed call pickup code on a per-line basis. X ranges from 1 to 6. <b>Note:</b> The directed call pickup code configured on a per-line basis takes precedence over that configured on a phone basis.
<b>Format</b>	String
<b>Default Value</b>	Blank
<b>Range</b>	0 to 32 characters
<b>Example</b>	account.1.direct_pickup_code = *68

## Group Call Pickup

### Phone Basis

Parameter-	Configuration File
features.pickup.group_pickup_enable	<y0000000000xx>.cfg
<b>Description</b>	Enables or disables the IP phone to display the GPickup soft key when the IP phone is off-hook.
<b>Format</b>	Boolean
<b>Default Value</b>	0
<b>Range</b>	0-Disabled 1-Enabled
<b>Example</b>	features.pickup.group_pickup_enable = 1

Parameter-	Configuration File
features.pickup.group_pickup_code	<y0000000000xx>.cfg
<b>Description</b>	Configures the group call pickup code on a phone basis. <b>Note:</b> The group call pickup code configured on a per-line basis takes precedence over that configured on a phone basis.
<b>Format</b>	String
<b>Default Value</b>	Blank
<b>Range</b>	Not Applicable
<b>Example</b>	features.pickup.group_pickup_code = *98

### Per-line Basis

Parameter-	Configuration File
account.x.group_pickup_code	<y0000000000xx>.cfg
<b>Description</b>	Configures the group call pickup code on a per-line basis. X ranges from 1 to 6. <b>Note:</b> The group call pickup code configured on a per-line basis takes precedence over

	that configured on a phone basis.
<b>Format</b>	String
<b>Default Value</b>	Blank
<b>Range</b>	0 to 32 characters
<b>Example</b>	account.1.group_pickup_code = *69

## Dialog Info Call Pickup

Parameter-	Configuration File
account.x.dialoginfo_callpickup	<MAC>.cfg
<b>Description</b>	Configures Dialog Info Call Pickup feature for account x. If set to 1 (Enabled), call pickup is implemented through SIP signals. X ranges from 1 to 6. <b>Note:</b> It is not applicable to the SIPT19P IP phone.
<b>Format</b>	Boolean
<b>Default Value</b>	0
<b>Range</b>	0-Disabled 1-Enabled
<b>Example</b>	account.1.dialoginfo_callpickup = 1

## Web Server Type

Parameter-	Configuration File
wui.http_enable	<y0000000000xx>.cfg
<b>Description</b>	Enables or disables the IP phone to access its web user interface using HTTP protocol. <b>Note:</b> If you change this parameter, the IP phone will reboot to make the change take effect.
<b>Format</b>	Boolean
<b>Default Value</b>	1
<b>Range</b>	0-Disabled 1-Enabled

<b>Example</b>	wui.http_enable = 1
----------------	---------------------

Parameter-	Configuration File
network.port.http	<y0000000000xx>.cfg
<b>Description</b>	Configures the HTTP port used to access the web user interface of the IP phone. The default HTTP port is 80. <b>Note:</b> If you change this parameter, the IP phone will reboot to make the change take effect.
<b>Format</b>	Integer
<b>Default Value</b>	80
<b>Range</b>	1 to 65535
<b>Example</b>	network.port.http = 90

Parameter-	Configuration File
wui.https_enable	<y0000000000xx>.cfg
<b>Description</b>	Enables or disables the IP phone to access its web user interface using HTTPS protocol. <b>Note:</b> If you change this parameter, the IP phone will reboot to make the change take effect.
<b>Format</b>	Boolean
<b>Default Value</b>	1
<b>Range</b>	0-Disabled 1-Enabled
<b>Example</b>	wui.https_enable = 1

Parameter-	Configuration File
network.port.https	<y0000000000xx>.cfg
<b>Description</b>	Configures the HTTPS port used to access the web user interface of the IP phone. The default HTTPS port is 443. <b>Note:</b> If you change this parameter, the IP phone will reboot to make the change take effect.

<b>Format</b>	Integer
<b>Default Value</b>	443
<b>Range</b>	1 to 65535
<b>Example</b>	network.port.https = 100

## Calling Line Identification Presentation

<b>Parameter-</b> account.x.cid_source	<b>Configuration File</b> <MAC>.cfg
<b>Description</b>	<p>Configures the presentation of the caller identity for account x.</p> <p><b>0</b>-FROM (Derives the name and number of the caller from the "From" header).</p> <p><b>1</b>-PAI (Derives the name and number of the caller from the "PAI" header. If the server does not send the "PAI" header, displays "anonymity" on the callee's phone).</p> <p><b>2</b>-PAI-FROM (Derives the name and number of the caller from the "PAI" header preferentially. If the server does not send the "PAI" header, derives from the "From" header).</p> <p><b>3</b>-RPID-PAI-FROM</p> <p><b>4</b>-PAI-RPID-FROM</p> <p><b>5</b>-RPID-FROM</p> <p>X ranges from 1 to 6.</p>
<b>Format</b>	Integer
<b>Default Value</b>	0
<b>Range</b>	0 to 5
<b>Example</b>	account.1.cid_source = 2

## Connected Line Identification Presentation

<b>Parameter-</b> account.x.cp_source	<b>Configuration File</b> <MAC>.cfg
<b>Description</b>	<p>Configures the presentation of the callee's identity for account x.</p> <p><b>0</b>-PAI-RPID (Derives the name and number of</p>

	<p>the callee from the "PAI" header preferentially. If the server does not send the "PAI" header, derives from the "RPID" header).</p> <p>1-Dialed Digits (Preferentially displays the dialed digits on the caller's phone).</p> <p>2-RFC 4916 (Derives the name and number of the callee from "From" header in the Update message).</p> <p>When the RFC 4916 is enabled on the IP phone, the caller sends the SIP request message which contains the from-change tag in the Supported header. The caller then receives an UPDATE message from the callee, and displays the identity in the From header.</p> <p>X ranges from 1 to 6.</p>
<b>Format</b>	Integer
<b>Default Value</b>	0
<b>Range</b>	0 to 2
<b>Example</b>	account.1.cp_source = 2

## DTMF

Parameter-	Configuration File
account.x.dtmf.type	<MAC>.cfg
<b>Description</b>	<p>Specifies the DTMF type for account x.</p> <p>If set to 0 (INBAND), DTMF digits are transmitted in the voice band.</p> <p>If set to 1 (RFC 2833), DTMF digits are transmitted by RTP Events compliant to RFC 2833.</p> <p>If set to 2 (SIP INFO), DTMF digits are transmitted by the SIP INFO messages.</p> <p>If set to 3 (AUTO+SIP INFO), negotiates with the other end to use INBAND or RFC 2833, if there is no negotiation, using SIP INFO by default.</p> <p>X ranges from 1 to 6.</p>



<b>Format</b>	Integer
<b>Default Value</b>	1
<b>Range</b>	<b>Valid values are:</b> <b>0</b> -INBAND <b>1</b> -RFC 2833 <b>2</b> -SIP INFO <b>3</b> -AUTO+SIP INFO
<b>Example</b>	account.1.dtmf.type = 2

<b>Parameter-</b> account.x.dtmf.dtmf_payload	<b>Configuration File</b> <MAC>.cfg
<b>Description</b>	Configures the RFC 2833 payload type. X ranges from 1 to 6.
<b>Format</b>	Integer
<b>Default Value</b>	101
<b>Range</b>	96 to 127
<b>Example</b>	account.1.dtmf.dtmf_payload = 101

<b>Parameter-</b> account.x.dtmf.info_type	<b>Configuration File</b> <MAC>.cfg
<b>Description</b>	Configures the DTMF info type when the DTMF type is configured as "SIP INFO" or "AUTO+SIP INFO". X ranges from 1 to 6.
<b>Format</b>	Integer
<b>Default Value</b>	1
<b>Range</b>	<b>Valid values are:</b> <b>1</b> -DTMF-Relay <b>2</b> -DTMF <b>3</b> -Telephone-Event
<b>Example</b>	account.1.dtmf.info_type = 3

<b>Parameter-</b> features.dtmf.repetition	<b>Configuration File</b> <y0000000000xx>.cfg
<b>Description</b>	Configures the number of times for the IP

	phone to send the end RTP EVENT packet.
<b>Format</b>	Integer
<b>Default Value</b>	3
<b>Range</b>	1 to 3
<b>Example</b>	features.dtmf.repetition = 2

## Suppress DTMF Display

<b>Parameter-</b> features.dtmf.hide	<b>Configuration File</b> <y0000000000xx>.cfg
<b>Description</b>	Enables or disables the IP phone to suppress the display of DTMF digits. If set to 1 (Enabled), the DTMF digits are displayed as asterisks.
<b>Format</b>	Boolean
<b>Default Value</b>	0
<b>Range</b>	0-Disabled 1-Enabled
<b>Example</b>	features.dtmf.hide = 1

<b>Parameter-</b> features.dtmf.hide_delay	<b>Configuration File</b> <y0000000000xx>.cfg
<b>Description</b>	Enables or disables the IP phone to display the DTMF digits for a short period before displaying asterisks. <b>Note:</b> It works only if the parameter "features.dtmf.hide" is set to 1 (Enabled).
<b>Format</b>	Boolean
<b>Default Value</b>	0
<b>Range</b>	0-Disabled 1-Enabled
<b>Example</b>	features.dtmf.hide_delay = 1

## Transfer via DTMF

Parameter-	Configuration File
features.dtmf.replace_tran	<y0000000000xx>.cfg
<b>Description</b>	<p>Enables or disables transfer via DTMF feature.</p> <p>If set to 0 (Disabled), the IP phone performs the transfer as normal when pressing the transfer key during a call.</p> <p>If set to 1 (Enabled), the IP phone transmits the specified DTMF digits to the server for completing call transfer when pressing the transfer key during a call.</p>
<b>Format</b>	Boolean
<b>Default Value</b>	0
<b>Range</b>	0-Disabled 1-Enabled
<b>Example</b>	features.dtmf.replace_tran = 1

Parameter-	Configuration File
features.dtmf.transfer	<y0000000000xx>.cfg
<b>Description</b>	<p>Specifies the DTMF digits to be transmitted to complete the transfer.</p> <p><b>Note:</b> It works only if the parameter "features.dtmf.replace_tran" is set to 1 (Enabled).</p>
<b>Format</b>	String
<b>Default Value</b>	Blank
<b>Range</b>	Valid values are: 0-9, *, # and A-D.
<b>Example</b>	features.dtmf.transfer = 123

## Incoming Intercom calls

Parameter-	Configuration File
features.intercom.allow	<y0000000000xx>.cfg
<b>Description</b>	Enables or disables the IP phone to automatically answer an incoming intercom

	<p>call.</p> <p>If set to 0 (Disabled), the IP phone rejects incoming intercom calls and sends a busy signal to the caller.</p> <p>If set to 1 (Enabled), the IP phone automatically answers an incoming intercom call.</p>
<b>Format</b>	Boolean
<b>Default Value</b>	1
<b>Range</b>	0-Disabled 1-Enabled
<b>Example</b>	features.intercom.allow = 1

<b>Parameter-</b> features.intercom.mute	<b>Configuration File</b> <y0000000000xx>.cfg
<b>Description</b>	<p>Enables or disables the IP phone to mute the microphone when answering an intercom call.</p> <p>If set to 0 (Disabled), the microphone is un-muted for incoming calls.</p> <p>If set to 1 (Enabled), the microphone is muted for intercom calls.</p>
<b>Format</b>	Boolean
<b>Default Value</b>	0
<b>Range</b>	0-Disabled 1-Enabled
<b>Example</b>	features.intercom.mute = 1

<b>Parameter-</b> features.intercom.tone	<b>Configuration File</b> <y0000000000xx>.cfg
<b>Description</b>	<p>Enables or disables the IP phone to play a warning tone when receiving an intercom call.</p> <p>If set to 0 (Disabled), the IP phone automatically answers the intercom call without a warning tone.</p> <p>If set to 1 (Enabled), the IP phone plays a</p>

	warning tone to alert you before answering the intercom call.
<b>Format</b>	Boolean
<b>Default Value</b>	1
<b>Range</b>	0-Disabled 1-Enabled
<b>Example</b>	features.intercom.tone = 1

<b>Parameter-</b>	<b>Configuration File</b>
features.intercom.barge	<y0000000000xx>.cfg
<b>Description</b>	<p>Enables or disables the IP phone to automatically answer an incoming intercom call while there is already an active call on the IP phone.</p> <p>If set to 0 (Disabled), the IP phone handles an incoming intercom call like a waiting call while there is already an active call on the IP phone.</p> <p>If set to 1 (Enabled), the IP phone automatically answers the intercom call while there is already an active call on the IP phone and puts the active call on hold.</p>
<b>Format</b>	Boolean
<b>Default Value</b>	0
<b>Range</b>	0-Disabled 1-Enabled
<b>Example</b>	features.intercom.barge = 1

## Distinctive Ring Tones

<b>Parameter-</b>	<b>Configuration File</b>
features.alert_info_tone	<y0000000000xx>.cfg
<b>Description</b>	Enables and disables the IP phone to map the keywords in the Alert-info header to the specified Bellcore ring tones.
<b>Format</b>	Boolean
<b>Default Value</b>	0

<b>Range</b>	0-Disabled 1-Enabled
<b>Example</b>	features.alert_info_tone = 1

<b>Parameter-</b> account.x.alert_info_url_enable	<b>Configuration File</b> <MAC>.cfg
<b>Description</b>	Enables or disables distinctive ring tones feature for account x. X ranges from 1 to 6.
<b>Format</b>	Boolean
<b>Default Value</b>	1
<b>Range</b>	0-Disabled 1-Enabled
<b>Example</b>	account.1.alert_info_url_enable = 1

<b>Parameter-</b> distinctive_ring_tones.alert_info. x.text	<b>Configuration File</b> <y0000000000xx>.cfg
<b>Description</b>	Specifies the texts to map the keywords contained in the SIP header. X ranges from 1 to 10.
<b>Format</b>	String
<b>Default Value</b>	Blank
<b>Range</b>	Not Applicable
<b>Example</b>	distinctive_ring_tones.alert_info.1.text = family

<b>Parameter-</b> distinctive_ring_tones.alert_info. x.ringer	<b>Configuration File</b> <y0000000000xx>.cfg
<b>Description</b>	Specifies the desired ring tones for each text. The value ranges from 1 to 5, the digit stands for the appropriate ring tone. X ranges from 1 to 10.
<b>Format</b>	Integer

<b>Default Value</b>	1
<b>Range</b>	<b>Valid values are:</b> 1-Ring1.wav 2-Ring2.wav 3-Ring3.wav 4-Ring4.wav 5-Ring5.wav
<b>Example</b>	distinctive_ring_tones.alert_info.1.ringer = 2

## Tones

<b>Parameter-</b>	<b>Configuration File</b>
voice.tone.country	<y0000000000xx>.cfg
<b>Description</b>	Configures the country tone for the IP phone.
<b>Format</b>	String
<b>Default Value</b>	Custom
<b>Range</b>	<b>Valid values are:</b> <ul style="list-style-type: none"> <li>• Custom</li> <li>• Australia</li> <li>• Austria</li> <li>• Brazil</li> <li>• Belgium</li> <li>• China</li> <li>• Czech</li> <li>• Denmark</li> <li>• Finland</li> <li>• France</li> <li>• Germany</li> <li>• Great Britain</li> <li>• Greece</li> <li>• Hungary</li> <li>• Lithuania</li> <li>• India</li> <li>• Italy</li> <li>• Japan</li> <li>• Mexico</li> <li>• New Zealand</li> <li>• Netherlands</li> <li>• Norway</li> </ul>

	<ul style="list-style-type: none"> <li>• Portugal</li> <li>• Spain</li> <li>• Switzerland</li> <li>• Sweden</li> <li>• Russia</li> <li>• United States</li> <li>• Chile</li> <li>• Czech ETSI</li> </ul>
<b>Example</b>	voice.tone.country = Austria

<b>Parameter-</b> voice.tone.dial voice.tone.ring voice.tone.busy voice.tone.congestion voice.tone.callwaiting voice.tone.dialrecall voice.tone.info voice.tone.stutter voice.tone.message voice.tone.autoanswer	<b>Configuration File</b> <y0000000000xx>.cfg
<b>Description</b>	<p>Customizes the tone for each condition.</p> <p>tonelist = element[,element] [,element]...</p> <p>Where</p> <p><b>element</b> = [!]<b>freq1</b> [+<b>freq2</b>][+<b>freq3</b>][+<b>freq4</b>]          /duration</p> <p><b>Freq:</b> the frequency of the tone (ranges from 200 to 7000 Hz). If set to 0 (0Hz), it means the tone is not played. A tone can be composited at most four different frequencies.</p> <p><b>Duration:</b> the time duration (in milliseconds, ranges from 0 to 30000ms) of the ring tone.</p> <p>You can configure at most eight different tones for one condition, separate tones by comma (e.g. 250/200, !0/1000, 200+300/500, 600+700+800+1000/2000). The exclamation point (!) can be added optionally, which means these tones are only played once.</p> <p><b>Note:</b> It works only if the parameter "voice.tone.country" is set to Custom.</p>



<b>Format</b>	Refer to the introduction above
<b>Default Value</b>	Blank
<b>Range</b>	Not Applicable
<b>Example</b>	voice.tone.dial = 800+200/1000, 0/100, 500/1200, 500+600+950+1500/5000

## Remote Phone Book

<b>Parameter-</b>	<b>Configuration File</b>
remote_phonebook.data.x.url	<y0000000000xx>.cfg
<b>Description</b>	Specifies the access URL of the remote XML phone book. X ranges from 1 to 5.
<b>Format</b>	URL
<b>Default Value</b>	Blank
<b>Range</b>	0 to 511 characters
<b>Example</b>	remote_phonebook.data.1.url = http://192.168.1.20/phonebook.xml

<b>Parameter-</b>	<b>Configuration File</b>
remote_phonebook.data.x.name	<y0000000000xx>.cfg
<b>Description</b>	Specifies the name of the remote phone book.
<b>Format</b>	String
<b>Default Value</b>	Blank
<b>Range</b>	0 to 99 characters
<b>Example</b>	remote_phonebook.data.1.name = yl01

<b>Parameter-</b> features.remote_phonebook.enable	<b>Configuration File</b> <y0000000000xx>.cfg
<b>Description</b>	Enables or disables the IP phone to perform a remote phone book search when receiving an incoming call.
<b>Format</b>	Boolean
<b>Default Value</b>	0
<b>Range</b>	0-Disabled 1-Enabled
<b>Example</b>	features.remote_phonebook.enable = 1

<b>Parameter-</b> features.remote_phonebook.flash_time	<b>Configuration File</b> <y0000000000xx>.cfg
<b>Description</b>	Sets how often to refresh the local cache of the remote phone book. If set to 3600 (3600s), the IP phone refreshes the local cache of the remote phone book every 3600 seconds.
<b>Format</b>	Integer
<b>Default Value</b>	21600
<b>Range</b>	120 to 2592000 <b>Note:</b> For SIP-T21P IP phone, the value ranges from 3600 to 2592000.
<b>Example</b>	features.remote_phonebook.flash_time = 3600

## LDAP

<b>Parameter-</b> ldap.name_filter	<b>Configuration File</b> <y0000000000xx>.cfg
<b>Description</b>	Specifies the name attribute for LDAP searching. The "*" symbol in the filter stands for any character. The "%" symbol in the filter stands for the entering string used as the prefix of the filter condition.

<b>Format</b>	String
<b>Default Value</b>	Blank
<b>Range</b>	0 to 99 characters
<b>Example</b>	<p>ldap.name_filter = ( (cn=%)(sn=%))</p> <p>When the name prefix of the cn or sn of the contact record matches the search criteria, the record will be displayed on the LCD screen.</p>

<b>Parameter-</b>	<b>Configuration File</b>
ldap.number_filter	<y0000000000xx>.cfg
<b>Description</b>	<p>Specifies the number attribute for LDAP searching.</p> <p>The "*" symbol in the filter stands for any character. The "%" symbol in the filter stands for the entering string used as the prefix of the filter condition.</p>
<b>Format</b>	String
<b>Default Value</b>	Blank
<b>Range</b>	0 to 99 characters
<b>Example</b>	<p>ldap.number_filter =</p> <p>( (telephoneNumber=%)(Mobile=%)(ipPhone=%))</p> <p>When the number prefix of the telephoneNumber, Mobile or ipPhone of the contact record matches the search criteria, the record will be displayed on the LCD screen.</p>

<b>Parameter-</b>	<b>Configuration File</b>
ldap.base	<y0000000000xx>.cfg
<b>Description</b>	<p>Specifies the LDAP search base which corresponds to the location in the LDAP phone book from which the LDAP search request begins. The search base narrows the search scope and decreases directory search time.</p>

<b>Format</b>	String
<b>Default Value</b>	Blank
<b>Range</b>	0 to 99 characters
<b>Example</b>	ldap.base = dc=yealink,dc=cn

<b>Parameter-</b>	<b>Configuration File</b>
ldap.host	<y0000000000xx>.cfg
<b>Description</b>	Specifies the domain name or IP address of the LDAP server.
<b>Format</b>	IP Address or Domain Name
<b>Default Value</b>	0.0.0.0
<b>Range</b>	Not Applicable
<b>Example</b>	ldap.host = 192.168.1.20

<b>Parameter-</b>	<b>Configuration File</b>
ldap.port	<y0000000000xx>.cfg
<b>Description</b>	Specifies the LDAP server port.
<b>Format</b>	Integer
<b>Default Value</b>	389
<b>Range</b>	1 to 65535
<b>Example</b>	ldap.port = 390

<b>Parameter-</b>	<b>Configuration File</b>
ldap.user	<y0000000000xx>.cfg
<b>Description</b>	Specifies the user name uses to login the LDAP server.  This parameter can be left blank in case the server allows anonymous to login. Otherwise you will need to provide the user name to access the LDAP server.
<b>Format</b>	String
<b>Default Value</b>	Blank
<b>Range</b>	0 to 99 characters

<b>Example</b>	ldap.user = cn=manager,dc=yealink,dc=cn
----------------	--

<b>Parameter-</b>	<b>Configuration File</b>
ldap.password	<y0000000000xx>.cfg
<b>Description</b>	Specifies the password to login the LDAP server.  This parameter can be left blank in case the server allows anonymous to login. Otherwise you will need to provide the password to access the LDAP server.
<b>Format</b>	String
<b>Default Value</b>	Blank
<b>Range</b>	0 to 99 characters
<b>Example</b>	ldap.password = secret

<b>Parameter-</b>	<b>Configuration File</b>
ldap.max_hits	<y0000000000xx>.cfg
<b>Description</b>	Specifies the maximum number of search results to be returned by the LDAP server. If the value of the "Max.Hits" is blank, the LDAP server will return all searched results. Please note that a very large value of the "Max. Hits" will slow down the LDAP search speed, therefore it should be configured according to the available bandwidth.
<b>Format</b>	Integer
<b>Default Value</b>	50
<b>Range</b>	1 to 32000
<b>Example</b>	ldap.max_hits = 60

<b>Parameter-</b>	<b>Configuration File</b>
ldap.name_attr	<y0000000000xx>.cfg
<b>Description</b>	Specifies the name attributes of each record to be returned by the LDAP server. It compresses the search results. You can

	configure multiple name attributes separated by space.
<b>Format</b>	String
<b>Default Value</b>	Blank
<b>Range</b>	0 to 99 characters
<b>Example</b>	ldap.name_attr = cn sn

<b>Parameter-</b> ldap.numb_attr	<b>Configuration File</b> <y0000000000xx>.cfg
<b>Description</b>	Specifies the number attributes of each record to be returned by the LDAP server. It compresses the search results. You can configure multiple number attributes separated by space.
<b>Format</b>	String
<b>Default Value</b>	Blank
<b>Range</b>	0 to 99 characters
<b>Example</b>	ldap.numb_attr = telephoneNumber

<b>Parameter-</b> ldap.display_name	<b>Configuration File</b> <y0000000000xx>.cfg
<b>Description</b>	Specifies the display name of the contact record displayed on the LCD screen. <b>Note:</b> It must start with "%" symbol.
<b>Format</b>	String
<b>Default Value</b>	Blank
<b>Range</b>	0 to 99 characters
<b>Example</b>	ldap.display_name = %cn The cn of the contact record is displayed on the LCD screen.

<b>Parameter-</b> ldap.version	<b>Configuration File</b> <y0000000000xx>.cfg
<b>Description</b>	Specifies the LDAP protocol version supported by the IP phone. Make sure the

	protocol value corresponds with the version assigned on the LDAP server.
<b>Format</b>	Integer
<b>Default Value</b>	3
<b>Range</b>	2 or 3
<b>Example</b>	ldap.version = 3

<b>Parameter-</b> ldap.call_in_lookup	<b>Configuration File</b> <y0000000000xx>.cfg
<b>Description</b>	Enables or disables the IP phone to perform an LDAP search when receiving an incoming call.
<b>Format</b>	Boolean
<b>Default Value</b>	0
<b>Range</b>	0-Disabled 1-Enabled
<b>Example</b>	ldap.call_in_lookup = 1

<b>Parameter-</b> ldap.ldap_sort	<b>Configuration File</b> <y0000000000xx>.cfg
<b>Description</b>	Enables or disables the IP phone to sort the search results in alphabetical order or numerical order.
<b>Format</b>	Boolean
<b>Default Value</b>	0
<b>Range</b>	0-Disabled 1-Enabled
<b>Example</b>	ldap.ldap_sort = 1

## BLF

### Visual and Audio Alert for BLF Pickup

<b>Parameter-</b> features.pickup.blf_visual_enable	<b>Configuration File</b> <y0000000000xx>.cfg
--	--

<b>Description</b>	Enables or disables the IP phone to display a visual prompt when the monitored user receives an incoming call. <b>Note:</b> It is not applicable to SIP-T19P and SIP-T20P IP phones.
<b>Format</b>	Boolean
<b>Default Value</b>	0
<b>Range</b>	0-Disabled 1-Enabled
<b>Example</b>	features.pickup.blf_visual_enable = 1

<b>Parameter-</b>	<b>Configuration File</b>
features.pickup.blf_audio_enable	<y0000000000xx>.cfg
<b>Description</b>	Enables or disables the IP phone to play an alert tone when the monitored user receives an incoming call. <b>Note:</b> It is not applicable to the SIP-T19P IP phone.
<b>Format</b>	Boolean
<b>Default Value</b>	0
<b>Range</b>	0-Disabled 1-Enabled
<b>Example</b>	features.pickup.blf_audio_enable = 1

#### LED Off in Idle

<b>Parameter-</b>	<b>Configuration File</b>
features.blf_and_callpark_idle_led_enable	<y0000000000xx>.cfg
<b>Description</b>	Enables or disabled LED off in idle feature. <b>Note:</b> It is not applicable to the SIP-T19P IP phone.
<b>Format</b>	Boolean
<b>Default Value</b>	0
<b>Range</b>	0-Disabled 1-Enabled
<b>Example</b>	features.blf_and_callpark_idle_led_enable = 1



## Music on Hold

Parameter-	Configuration File
account.x.music_server_uri	<MAC>.cfg
Description	Specifies the Music on Hold server address. Examples for valid values: <10.1.3.165>, 10.1.3.165, sip:moh@sip.com, <sip:moh@sip.com>, <yealink.com> or yealink.com. X ranges from 1 to 6. <b>Note:</b> The DNS query in this parameter only supports A query.
Format	String
Default Value	Blank
Range	Not Applicable
Example	account.1.music_server_uri = <10.1.3.165>

## ACD

Parameter-	Configuration File
account.x.acd.enable	<MAC>.cfg
Description	Enables or disables ACD feature for account x. X ranges from 1 to 6.
Format	Boolean
Default Value	0
Value	0-Disabled 1-Enabled
Example	account.1.acd.enable = 1

Parameter-	Configuration File
account.x.acd.available	MAC.cfg
Description	Enables or disables the IP phone to display the available and unavailable soft keys after the phone logs into the ACD system for account x.

	X ranges from 1 to 6.
<b>Format</b>	Boolean
<b>Default Value</b>	0
<b>Value</b>	0-Disabled 1-Enabled
<b>Example</b>	account.1.acd.available = 1

<b>Parameter-</b> acd.auto_available	<b>Configuration File</b> <y0000000000xx>.cfg
<b>Description</b>	Enables or disables ACD auto available feature. If set to 1 (Enabled), the IP phone automatically changes the phone status to available.
<b>Format</b>	Boolean
<b>Default Value</b>	0
<b>Value</b>	0-Disabled 1-Enabled
<b>Example</b>	acd.auto_available = 1

<b>Parameter-</b> acd.auto_available_timer	<b>Configuration File</b> <y0000000000xx>.cfg
<b>Description</b>	Specifies the length of time (in seconds) before the IP phone state is automatically changed to available. <b>Note:</b> It works only if the parameter "acd.auto_available" is set to 1 (Enabled).
<b>Format</b>	Integer
<b>Default Value</b>	60
<b>Value</b>	0 to 120
<b>Example</b>	acd.auto_available_timer = 80

## Message Waiting Indicator

<b>Parameter-</b> account.x.subscribe_mwi	<b>Configuration File</b> <MAC>.cfg
--	--

<b>Description</b>	Enables or disables the IP phone to subscribe the message waiting indicator to the account for account x. If set to 1 (Enabled), the IP phone sends a SUBSCRIBE message to the server for message-summary updates. X ranges from 1 to 6.
<b>Format</b>	Boolean
<b>Default Value</b>	0
<b>Value</b>	0-Disabled 1-Enabled
<b>Example</b>	account.1.subscribe_mwi = 0

<b>Parameter-</b> account.x.subscribe_mwi_expires	<b>Configuration File</b> <MAC>.cfg
<b>Description</b>	Configures MWI subscribe expiry time (in seconds) for account x. The IP phone is able to successfully refresh the SUBSCRIBE for message-summary events before expiration of the SUBSCRIBE dialog. X ranges from 1 to 6. <b>Note:</b> It works only if the parameter "account.x.subscribe_mwi" is set to 1 (Enabled).
<b>Format</b>	Integer
<b>Default Value</b>	3600
<b>Value</b>	0 to 84600
<b>Example</b>	account.1.subscribe_mwi_expires = 3600

<b>Parameter-</b> voice_mail.number.x	<b>Configuration File</b> <MAC>.cfg
<b>Description</b>	Configures the voice mail number for account x. X ranges from 1 to 6.
<b>Format</b>	String
<b>Default Value</b>	Blank

<b>Value</b>	Not Applicable
<b>Example</b>	voice_mail.number.1 = 1234

Parameter-	Configuration File
account.x.subscribe_mwi_to_vm	<MAC>.cfg
<b>Description</b>	Enables or disables the IP phone to subscribe the message waiting indicator to the voice mail number for account x. X ranges from 1 to 6. <b>Note:</b> It works only if the parameters "account.x.subscribe_mwi" is set to 1 (Enabled) and "voice_mail.number.x" is configured.
<b>Format</b>	Boolean
<b>Default Value</b>	0
<b>Value</b>	0-Disabled 1-Enabled
<b>Example</b>	account.1.subscribe_mwi_to_vm = 0

## Sending RTP Stream

Parameter-	Configuration File
multicast.codec	<y0000000000xx>.cfg
<b>Description</b>	Specifies a multicast codec for the IP phone to use to send an RTP stream. <b>Note:</b> It is not applicable to the SIP-T19P IP phone.
<b>Format</b>	string
<b>Default Value</b>	G722
<b>Range</b>	<b>Valid values are:</b> <ul style="list-style-type: none"> <li>• PCMU</li> <li>• PCMA</li> <li>• G729</li> <li>• G722</li> <li>• G726-16 (not applicable to SIP-T21P)</li> <li>• G726-24 (not applicable to SIP-T21P)</li> <li>• G726-32</li> <li>• G726-40 (not applicable to SIP-T21P)</li> <li>• G723_53</li> </ul>
<b>Example</b>	multicast.codec = G722

## Receiving RTP Stream

Parameter-	Configuration File
multicast.receive_priority.enable	<y0000000000xx>.cfg
<b>Description</b>	Enables or disables the IP phone to handle the incoming multicast paging calls when there is an active multicast paging call on the IP phone.  If set to 1 (Enabled), the IP phone will answer the incoming multicast paging call with a higher priority and ignore that with a lower priority.
<b>Format</b>	Boolean
<b>Default Value</b>	1
<b>Range</b>	0-Disabled 1-Enabled
<b>Example</b>	multicast.receive_priority.enable = 1

Parameter-	Configuration File
multicast.receive_priority.priority	< y0000000000xx >.cfg
<b>Description</b>	Configures the priority of multicast paging calls.  1 is the highest priority, 10 is the lowest priority.  If set to 0, all incoming multicast paging calls will be automatically ignored.
<b>Format</b>	Integer
<b>Default Value</b>	10
<b>Range</b>	0 to10
<b>Example</b>	multicast.receive_priority.priority = 10

Parameter-	Configuration File
multicast.listen_address.x.label	< y0000000000xx >.cfg
<b>Description</b>	Configures the label to be displayed on the LCD screen when receiving the RTP multicast.

	X ranges from 1 to 10.
<b>Format</b>	String
<b>Default Value</b>	Blank
<b>Range</b>	Not Applicable
<b>Example</b>	multicast.listen_address.1.label = 10

<b>Parameter-</b> multicast.listen_address.x.ip_address	<b>Configuration File</b> < y0000000000xx >.cfg
<b>Description</b>	Configures the multicast address and port number that the IP phone listens to. X ranges from 1 to 10. <b>Note:</b> The valid multicast IP addresses range from 224.0.0.0 to 239.255.255.255.
<b>Format</b>	String
<b>Default Value</b>	Blank
<b>Range</b>	Not Applicable
<b>Example</b>	multicast.listen_address.1.ip_address = 224.5.6.20:10008

## Action URL

<b>Parameter-</b> action_url.setup_completed action_url.log_on action_url.log_off action_url.register_failed action_url.off_hook action_url.on_hook action_url.incoming_call action_url.outgoing_call action_url.call_established action_url.dnd_on action_url.dnd_off action_url.always_fwd_on	<b>Configuration File</b> <y0000000000xx>.cfg
---	--

<p>action_url.always_fwd_off  action_url.busy_fwd_on  action_url.busy_fwd_off  action_url.no_answer_fwd_on  action_url.no_answer_fwd_off  action_url.transfer_call  action_url.blind_transfer_call  action_url.attended_transfer_call  action_url.hold  action_url.unhold  action_url.mute  action_url.unmute  action_url.missed_call  action_url.call_terminated  action_url.busy_to_idle  action_url.idle_to_busy  action_url.ip_change  action_url.forward_incoming_call  action_url.reject_incoming_call  action_url.answer_new_incoming_call  action_url.transfer_finished  action_url.transfer_failed  action_url.call_interrupt  action_url.setup_autop_finish</p>	
<p><b>Description</b></p>	<p>Specifies the URL for the predefined event.  The value format is: http(s)://IP address of server/help.xml? variable name=variable value</p> <p><b>Valid variable values are:</b></p> <ul style="list-style-type: none"> <li>• \$mac</li> <li>• \$ip</li> <li>• \$model</li> <li>• \$firmware</li> <li>• \$active_url</li> <li>• \$active_user</li> <li>• \$active_host</li> <li>• \$local</li> <li>• \$remote</li> </ul>



	<ul style="list-style-type: none"> <li>• \$display_local</li> <li>• \$display_remote</li> <li>• \$call_id</li> </ul>
<b>Format</b>	URL
<b>Default Value</b>	Not Applicable
<b>Range</b>	Not Applicable
<b>Example</b>	<pre>action_url.mute = http://192.168.0.20/help.xml?model=\$mo del</pre>

## Action URI

Parameter-	Configuration File
features.action_uri_limit_ip	<y0000000000xx>.cfg
<b>Description</b>	<p>Specifies the address(es) from which Action URI will be accepted.</p> <p>For discontinuous IP addresses, multiple IP addresses are separated by comma.</p> <p>For continuous IP addresses, the format likes *.*.* and the "*" stands for the values 0~255.</p> <p>For example: 10.10.*.* stands for the IP addresses that range from 10.10.0.0 to 10.10.255.255.</p> <p>If left blank, the IP phone cannot receive or handle any HTTP GET request.</p> <p>If set to "any", the IP phone accepts and handles HTTP GET requests from any IP address.</p>
<b>Format</b>	IP Address
<b>Default Value</b>	Blank
<b>Range</b>	IP address or any
<b>Example</b>	features.action_uri_limit_ip = any

## Server Redundancy

Parameter- account.x.sip_server.y.address	Configuration File <MAC>.cfg
<b>Description</b>	Configures the IP address or domain name of the SIP server. X ranges from 1 to 6. Y ranges from 1 to 2.
<b>Format</b>	IP Address or Domain Name
<b>Default Value</b>	Blank
<b>Range</b>	Not Applicable
<b>Example</b>	account.1.sip_server.1.address = sip:user@example.com

Parameter- account.x.sip_server.y.port	Configuration File <MAC>.cfg
<b>Description</b>	Configures the SIP server port. X ranges from 1 to 6. Y ranges from 1 to 2.
<b>Format</b>	Integer
<b>Default Value</b>	5060
<b>Range</b>	0 to 65535
<b>Example</b>	account.1.sip_server.1.port = 5060

Parameter- account.x.sip_server.y.expires	Configuration File <MAC>.cfg
<b>Description</b>	Configures the registration expires (in seconds). X ranges from 1 to 6. Y ranges from 1 to 2.
<b>Format</b>	Integer
<b>Default Value</b>	3600
<b>Range</b>	30 to 2147483647
<b>Example</b>	account.1.sip_server.1.expires = 3600

Parameter-	Configuration File
account.x.sip_server.y.retry_counts	<MAC>.cfg
<b>Description</b>	Configures the retry times for the IP phone to resend requests when the server does not respond correctly. X ranges from 1 to 6. Y ranges from 1 to 2.
<b>Format</b>	Integer
<b>Default Value</b>	3
<b>Range</b>	0 to 20
<b>Example</b>	account.1.sip_server.1.retry_counts = 3

### Fallback Mode

Parameter-	Configuration File
account.x.fallback.redundancy_type	<MAC>.cfg
<b>Description</b>	Configures the registration mode for the IP phone in fallback mode. X ranges from 1 to 6.
<b>Format</b>	Integer
<b>Default Value</b>	0
<b>Range</b>	<b>Valid values are:</b> 0-Concurrent registration 1-Successive registration
<b>Example</b>	account.1.fallback.redundancy_type = 0

Parameter-	Configuration File
account.x.fallback.timeout	<MAC>.cfg
<b>Description</b>	Configures the time interval (in seconds) for the IP phone to detect whether the working server is available by sending the registration request after the fallback server takes over the call control. It is only applicable to successive registration mode. X ranges from 1 to 6.

<b>Format</b>	Integer
<b>Default Value</b>	120
<b>Range</b>	10 to 2147483647
<b>Example</b>	account.1.failback.timeout = 120

### Failover Mode

<b>Parameter-</b> account.x.sip_server.y.failback_mode	<b>Configuration File</b> <MAC>.cfg
<b>Description</b>	Configures the way in which the phone fails back to the primary server for call control when in the failover mode.  X ranges from 1 to 6. Y ranges from 1 to 2.
<b>Format</b>	Integer
<b>Default Value</b>	0
<b>Range</b>	<b>Valid values are:</b>  <b>0</b> -newRequests: all requests are forwarded to the primary server first, regardless of the secondary server that was used.  <b>1</b> -DNSTTL: the IP phone will retry to use the primary server after the timeout of the DNSTTL configured for the SIP server.  <b>2</b> -registration: the IP phone will retry to use the primary server when the SIP server's registration requires renewal.  <b>3</b> -duration: the IP phone will retry to use the primary server after the timeout defined by the account.x.failback_timeout parameter.
<b>Example</b>	account.1.sip_server.1.failback_mode = 0

<b>Parameter-</b> account.x.sip_server.y.failback_timeout	<b>Configuration File</b> <MAC>.cfg
<b>Description</b>	Configures the time interval (in seconds) for the IP phone to detect whether the primary server is available by sending the

	<p>registration request after the secondary server takes over the call control.</p> <p>X ranges from 1 to 6.</p> <p>Y ranges from 1 to 2.</p>
<b>Format</b>	Integer
<b>Default Value</b>	3600
<b>Range</b>	0 to 65535
<b>Example</b>	account.1.sip_server.1.failback_timeout = 3600

<b>Parameter-</b>	<b>Configuration File</b>
account.x.sip_server.y.register_on_enable	<MAC>.cfg
<b>Description</b>	<p>Enables or disables the IP phone to register to the secondary server before sending requests to the secondary server in the failover mode.</p> <p>X ranges from 1 to 6.</p> <p>Y ranges from 1 to 2.</p>
<b>Format</b>	Boolean
<b>Default Value</b>	0
<b>Range</b>	<p>0-Disabled</p> <p>1-Enabled</p>
<b>Example</b>	account.1.sip_server.1.register_on_enable = 0

## SIP Server Domain Name Resolution

<b>Parameter-</b>	<b>Configuration File</b>
account.x.transport	<MAC>.cfg
<b>Description</b>	<p>Configures the transport type for account x.</p> <p>If the parameter is set to 3 (DNS-NAPTR) and no server port is given, the IP phone performs the DNS NAPTR and SRV queries for the service type and port.</p> <p>X ranges from 1 to 6.</p>
<b>Format</b>	Integer

<b>Default Value</b>	0
<b>Range</b>	<b>Valid values are:</b> 0-UDP 1-TCP 2-TLS 3-DNS-NAPTR
<b>Example</b>	account.1.transport = 3

<b>Parameter-</b> account.x.naptr_build	<b>Configuration File</b> <MAC>.cfg
<b>Description</b>	Specifies the type of the SRV query when the NAPTR query returns no result. X ranges from 1 to 6.
<b>Format</b>	Integer
<b>Default Value</b>	0
<b>Range</b>	<b>Valid values are:</b> 0-UDP 1-TCP or TLS.
<b>Example</b>	account.1.naptr_build = 1

## LLDP

<b>Parameter-</b> network.lldp.enable	<b>Configuration File</b> <y0000000000xx>.cfg
<b>Description</b>	Enables or disables LLDP feature on the IP phone. <b>Note:</b> If you change this parameter, the IP phone will reboot to make the change take effect.
<b>Format</b>	Boolean
<b>Default Value</b>	1
<b>Range</b>	0-Disabled 1-Enabled
<b>Example</b>	network.lldp.enable = 1

Parameter-	Configuration File
network.lldp.packet_interval	<y0000000000xx>.cfg
Description	Configures the amount of time (in seconds) between the transmissions of LLDP packet. <b>Note:</b> If you change this parameter, the IP phone will reboot to make the change take effect. It works only if the parameter "network.lldp.enable" is set to 1 (Enabled).
Format	Integer
Default Value	60
Range	1 to 3600
Example	network.lldp.packet_interval = 150

## VLAN

### Internet Port

Parameter-	Configuration File
network.vlan.internet_port_enable	<y0000000000xx>.cfg
Description	Enables or disables the IP phone to insert VLAN tag on packet from the Internet port. <b>Note:</b> If you change this parameter, the IP phone will reboot to make the change take effect.
Format	Boolean
Default Value	0
Range	0-Disabled 1-Enabled
Example	network.vlan.internet_port_enable = 1

Parameter-	Configuration File
network.vlan.internet_port_vid	<y0000000000xx>.cfg
Description	Configures the VLAN ID that is associated with the particular VLAN. <b>Note:</b> If you change this parameter, the IP phone will reboot to make the change take effect.

<b>Format</b>	Integer
<b>Default Value</b>	1
<b>Range</b>	1 to 4094
<b>Example</b>	network.vlan.internet_port_vid = 1

<b>Parameter-</b>	<b>Configuration File</b>
network.vlan.internet_port_priority	<y0000000000xx>.cfg
<b>Description</b>	Specifies the priority value used for passing VLAN packets. 7 is the highest priority, 0 is the lowest priority. <b>Note:</b> If you change this parameter, the IP phone will reboot to make the change take effect.
<b>Format</b>	Integer
<b>Default Value</b>	0
<b>Range</b>	0 to 7
<b>Example</b>	network.vlan.internet_port_priority = 1

### PC Port

<b>Parameter-</b>	<b>Configuration File</b>
network.vlan.pc_port_enable	<y0000000000xx>.cfg
<b>Description</b>	Enables or disables the IP phone to insert VLAN tag on packet from the PC port. <b>Note:</b> If you change this parameter, the IP phone will reboot to make the change take effect.
<b>Format</b>	Boolean
<b>Default Value</b>	0
<b>Range</b>	0-Disabled 1-Enabled
<b>Example</b>	network.vlan.pc_port_enable = 1



Parameter-	Configuration File
network.vlan.pc_port_vid	<y0000000000xx>.cfg
<b>Description</b>	Configures the VLAN ID that is associated with the particular VLAN. <b>Note:</b> If you change this parameter, the IP phone will reboot to make the change take effect.
<b>Format</b>	Integer
<b>Default Value</b>	1
<b>Range</b>	1 to 4094
<b>Example</b>	network.vlan.pc_port_vid = 1

Parameter-	Configuration File
network.vlan.pc_port_priority	<y0000000000xx>.cfg
<b>Description</b>	Specifies the priority value used for passing VLAN packets. <b>Note:</b> If you change this parameter, the IP phone will reboot to make the change take effect.
<b>Format</b>	Integer
<b>Default Value</b>	0
<b>Range</b>	0 to 7
<b>Example</b>	network.vlan.pc_port_priority = 1

### DHCP VLAN Discovery

Parameter-	Configuration File
network.vlan.dhcp_enable	<y0000000000xx>.cfg
<b>Description</b>	Enables or disables DHCP VLAN discovery feature on the IP phone. <b>Note:</b> If you change this parameter, the IP phone will reboot to make the change take effect.
<b>Format</b>	Boolean
<b>Default Value</b>	1
<b>Range</b>	0-Disabled 1-Enabled

<b>Example</b>	network.vlan.dhcp_enable = 1
----------------	------------------------------

<b>Parameter-</b> network.vlan.dhcp_option	<b>Configuration File</b> <y0000000000xx>.cfg
<b>Description</b>	Specifies the DHCP option used to request the VLAN ID.
<b>Format</b>	String
<b>Default Value</b>	132
<b>Range</b>	128 to 254
<b>Example</b>	network.vlan.dhcp_option = 140

## VPN

<b>Parameter-</b> network.vpn_enable	<b>Configuration File</b> <y0000000000xx>.cfg
<b>Description</b>	Enables or disables VPN feature on the IP phone. <b>Note:</b> If you change this parameter, the IP phone will reboot to make the change take effect.
<b>Format</b>	Boolean
<b>Default Value</b>	0
<b>Range</b>	0-Disabled 1-Enabled
<b>Example</b>	network.vpn_enable = 1

<b>Parameter-</b> openvpn.url	<b>Configuration File</b> <y0000000000xx>.cfg
<b>Description</b>	Specifies the access URL of the OpenVPN tar package.
<b>Format</b>	String
<b>Default Value</b>	Blank
<b>Range</b>	Not Applicable
<b>Example</b>	openvpn.url = http://192.168.10.25/OpenVPN.tar

## QoS

Parameter-	Configuration File
network.qos.rtptos	<y0000000000xx>.cfg
Description	Configures the DSCP for voice packets. The default DSCP value for RTP packets is 46 (Expedited Forwarding). <b>Note:</b> If you change this parameter, the IP phone will reboot to make the change take effect.
Format	Integer
Default Value	46
Range	0 to 63
Example	network.qos.rtptos = 50

Parameter-	Configuration File
network.qos.signaltos	<y0000000000xx>.cfg
Description	Configures the DSCP for SIP packets. The default DSCP value for SIP packets is 26 (Assured Forwarding). <b>Note:</b> If you change this parameter, the IP phone will reboot to make the change take effect.
Format	Integer
Default Value	26
Range	0 to 63
Example	network.qos.signaltos = 30

## Network Address Translation

Parameter-	Configuration File
account.x.nat.nat_traversal	<MAC>.cfg
Description	Enables or disables the NAT traversal for account x. X ranges from 1 to 6.

<b>Format</b>	Boolean
<b>Default Value</b>	0
<b>Range</b>	0-Disabled 1-Enabled
<b>Example</b>	account.1.nat.nat_traversal = 1

<b>Parameter-</b> account.x.nat.stun_server	<b>Configuration File</b> <MAC>.cfg
<b>Description</b>	Specifies the IP address or the domain name of the STUN server for account x. X ranges from 1 to 6.
<b>Format</b>	IP Address or Domain Name
<b>Default Value</b>	Blank
<b>Range</b>	Not Applicable
<b>Example</b>	account.1.nat.stun_server = 192.168.1.20

<b>Parameter-</b> account.x.nat.stun_port	<b>Configuration File</b> <MAC>.cfg
<b>Description</b>	Specifies the port of the STUN server. X ranges from 1 to 6.
<b>Format</b>	Integer
<b>Default Value</b>	3478
<b>Range</b>	Not Applicable
<b>Example</b>	account.1.nat.stun_port = 3479

## SNMP

<b>Parameter-</b> network.snmp.enable	<b>Configuration File</b> <y0000000000xx>.cfg
<b>Description</b>	Enables or disables SNMP feature on the IP phone. <b>Note:</b> If you change this parameter, the IP phone will reboot to make the change take effect.

<b>Format</b>	Boolean
<b>Default Value</b>	0
<b>Range</b>	0-Disabled 1-Enabled
<b>Example</b>	network.snmp.enable = 1

<b>Parameter-</b> network.snmp.port	<b>Configuration File</b> <y0000000000xx>.cfg
<b>Description</b>	Specifies the port used for SNMP communication. <b>Note:</b> If you change this parameter, the IP phone will reboot to make the change take effect.
<b>Format</b>	Integer
<b>Default Value</b>	Blank
<b>Range</b>	1 to 65535
<b>Example</b>	network.snmp.port = 1008

<b>Parameter-</b> network.snmp.trust_ip	<b>Configuration File</b> <y0000000000xx>.cfg
<b>Description</b>	Specifies the IP addresses from which SNMP requests will be accepted. Multiple IP addresses are separated by space. <b>Note:</b> If you change this parameter, the IP phone will reboot to make the change take effect.
<b>Format</b>	IP Address
<b>Default Value</b>	Blank
<b>Range</b>	Not Applicable
<b>Example</b>	network.snmp.trust_ip = 192.168.1.50 192.168.1.51

## 802.1X

Parameter-	Configuration File
network.802_1x.mode	<y0000000000xx>.cfg
<b>Description</b>	Specifies the types of the 802.1X authentication to use on the IP phone. <b>Note:</b> If you change this parameter, the IP phone will reboot to make the change take effect.
<b>Format</b>	Integer
<b>Default Value</b>	0
<b>Range</b>	<b>Valid values are:</b> 0-Disabled 1-EAP-MD5 2-EAP-TLS 3-PEAP-MSCHAPv2 4-EAP-TTLS/EAP-MSCHAPv2
<b>Example</b>	network.802_1x.mode = 1

Parameter-	Configuration File
network.802_1x.identity	<y0000000000xx>.cfg
<b>Description</b>	Enters the identity used for authenticating the IP phone. <b>Note:</b> If you change this parameter, the IP phone will reboot to make the change take effect.
<b>Format</b>	String
<b>Default Value</b>	Blank
<b>Range</b>	0 to 32 characters
<b>Example</b>	network.802_1x.identity = admin

Parameter-	Configuration File
network.802_1x.md5_password	<y0000000000xx>.cfg
<b>Description</b>	Enters the password used for authenticating the IP phone. <b>Note:</b> If you change this parameter, the IP

	phone will reboot to make the change take effect. It is only applicable to EAP-MD5, PEAP-MSCHAPv2 and EAP-TTLS/EAP-MSCHAPv2 protocols.
<b>Format</b>	String
<b>Default Value</b>	Blank
<b>Range</b>	0 to 32 characters
<b>Example</b>	network.802_1x.md5_password = admin123

<b>Parameter-</b>	<b>Configuration File</b>
network.802_1x.root_cert_url	<y0000000000xx>.cfg
<b>Description</b>	Specifies the access URL of the root certificate used for authentication. <b>Note:</b> If you change this parameter, the IP phone will reboot to make the change take effect. It is only applicable to EAP-TLS, PEAP-MSCHAPv2 and EAP-TTLS/EAP-MSCHAPv2 protocols. The format of the certificate must be *.pem, *.crt, *.cer or *.der.
<b>Format</b>	String
<b>Default Value</b>	Blank
<b>Range</b>	0 to 512 characters
<b>Example</b>	network.802_1x.root_cert_url = http://192.168.1.10/ca.pem

<b>Parameter-</b>	<b>Configuration File</b>
network.802_1x.client_cert_url	<y0000000000xx>.cfg
<b>Description</b>	Specifies the access URL of the client certificate used for authentication. <b>Note:</b> If you change this parameter, the IP phone will reboot to make the change take effect. It is only applicable to the EAP-TLS protocol. The format of the certificate must be *.pem or *.cer.
<b>Format</b>	String

<b>Default Value</b>	Blank
<b>Range</b>	0 to 512 characters
<b>Example</b>	network.802_1x.client_cert_url = http://192.168.1.10/ client.pem

## TR-069

<b>Parameter-</b> managementserver.enable	<b>Configuration File</b> <y0000000000xx>.cfg
<b>Description</b>	Enables or disables TR-069 feature on the IP phone. <b>Note:</b> If you change this parameter, the IP phone will reboot to make the change take effect.
<b>Format</b>	Integer
<b>Default Value</b>	0
<b>Range</b>	0-Disabled 1-Enabled
<b>Example</b>	managementserver.enable = 1

<b>Parameter-</b> managementserver.username	<b>Configuration File</b> <y0000000000xx>.cfg
<b>Description</b>	Enters the user name to authenticate with the ACS. This string is set to the empty string if no authentication is required. <b>Note:</b> If you change this parameter, the phone will reboot to make the change take effect.
<b>Format</b>	String
<b>Default Value</b>	Blank
<b>Range</b>	0 to 128 characters
<b>Example</b>	managementserver.username = user1

<b>Parameter-</b> managementserver.password	<b>Configuration File</b> <y0000000000xx>.cfg
<b>Description</b>	Enters the password to authenticate with



	the ACS. This string is set to the empty string if no authentication is required. <b>Note:</b> If you change this parameter, the phone will reboot to make the change take effect.
<b>Format</b>	String
<b>Default Value</b>	Blank
<b>Range</b>	0 to 64 characters
<b>Example</b>	managementserver.password = pwd123

<b>Parameter-</b> managementserver.url	<b>Configuration File</b> <y0000000000xx>.cfg
<b>Description</b>	Specifies the URL of the ACS. <b>Note:</b> If you change this parameter, the phone will reboot to make the change take effect.
<b>Format</b>	String
<b>Default Value</b>	Blank
<b>Range</b>	0 to 511 characters
<b>Example</b>	managementserver.url = http://192.168.1.20/acs/

<b>Parameter-</b> managementserver.connection_request_username	<b>Configuration File</b> <y0000000000xx>.cfg
<b>Description</b>	Sets the user name for the IP phone to authenticate the incoming connection requests. <b>Note:</b> If you change this parameter, the IP phone will reboot to make the change take effect.
<b>Format</b>	String
<b>Default Value</b>	Blank
<b>Range</b>	0 to 128 characters
<b>Example</b>	managementserver.connection_request_username = acsuser

<b>Parameter-</b> managementserver.connection_request_password	<b>Configuration File</b> <y0000000000xx>.cfg
<b>Description</b>	Sets the password for the IP phone to authenticate the incoming connection requests. <b>Note:</b> If you change this parameter, the IP phone will reboot to make the change take effect.
<b>Format</b>	String
<b>Default Value</b>	Blank
<b>Range</b>	0 to 64 characters
<b>Example</b>	managementserver.connection_request_password = acspwd

<b>Parameter-</b> managementserver.periodic_inform_enable	<b>Configuration File</b> <y0000000000xx>.cfg
<b>Description</b>	Enables or disables the IP phone to periodically report its configuration information to the ACS. <b>Note:</b> If you change this parameter, the IP phone will reboot to make the change take effect.
<b>Format</b>	Boolean
<b>Default Value</b>	1
<b>Range</b>	0-Disabled 1-Enabled
<b>Example</b>	managementserver.periodic_inform_enable = 1

<b>Parameter-</b> managementserver.periodic_inform_interval	<b>Configuration File</b> <y0000000000xx>.cfg
<b>Description</b>	Sets the interval (in seconds) to report its configuration information to the ACS. <b>Note:</b> If you change this parameter, the IP phone will reboot to make the change take

	effect.
<b>Format</b>	Integer
<b>Default Value</b>	60
<b>Range</b>	5 to 4294967295
<b>Example</b>	managementserver.periodic_inform_interval = 120

## IPv6

Parameter-	Configuration File
network.ip_address_mode	<MAC>.cfg
<b>Description</b>	Specifies the IP address mode. <b>Note:</b> If you change this parameter, the IP phone will reboot to make the change take effect.
<b>Format</b>	Integer
<b>Default Value</b>	0
<b>Range</b>	<b>Valid values are:</b> 0-IPv4 1-IPv6 2-IPv4&IPv6
<b>Example</b>	network.ip_address_mode = 1

Parameter-	Configuration File
network.ipv6_internet_port.type	<MAC>.cfg
<b>Description</b>	Specifies the IPv6 address assignment method. <b>Note:</b> If you change this parameter, the IP phone will reboot to make the change take effect.
<b>Format</b>	Integer
<b>Default Value</b>	0
<b>Range</b>	<b>Valid values are:</b> 0-DHCP 1-Static IP Address
<b>Example</b>	network.ipv6_internet_port.type = 1

Parameter-	Configuration File
network.ipv6_internet_port.ip	<MAC>.cfg
<b>Description</b>	Configures the IPv6 address when the IPv6 address assignment method is configured as Static IP Address and the IP add mode is configured as IPv6 or IPv4&IPv6.  <b>Note:</b> If you change this parameter, the IP phone will reboot to make the change take effect.
<b>Format</b>	IP Address
<b>Default Value</b>	Blank
<b>Range</b>	Not Applicable
<b>Example</b>	network.ipv6_internet_port.ip = 2026:1234:1:1:215:65ff:fe1f:caa

Parameter-	Configuration File
network.ipv6_prefix	<MAC>.cfg
<b>Description</b>	Specifies the prefix of the IPv6 address when the IPv6 address assignment method is configured as Static IP Address and the IP add mode is configured as IPv6 or IPv4&IPv6.  <b>Note:</b> If you change this parameter, the IP phone will reboot to make the change take effect.
<b>Format</b>	Integer
<b>Default Value</b>	64
<b>Range</b>	0 to 128
<b>Example</b>	network.ipv6_prefix = 68

Parameter-	Configuration File
network.ipv6_internet_port.gateway	<MAC>.cfg
<b>Description</b>	Configures the gateway when the IPv6 address assignment method is configured as Static IP Address and the IP add mode is configured as IPv6 or

	IPv4&IPv6. <b>Note:</b> If you change this parameter, the IP phone will reboot to make the change take effect.
<b>Format</b>	IP Address
<b>Default Value</b>	Blank
<b>Range</b>	Not Applicable
<b>Example</b>	network.ipv6_internet_port.gateway = 3036:1:1:c3c7:c11c:5447:23a6:255

<b>Parameter-</b> network.ipv6_primary_dns	<b>Configuration File</b> <MAC>.cfg
<b>Description</b>	Configures the primary DNS server when the IPv6 address assignment method is configured as Static IP Address and the IP add mode is configured as IPv6 or IPv4&IPv6. <b>Note:</b> If you change this parameter, the IP phone will reboot to make the change take effect.
<b>Format</b>	IP Address
<b>Default Value</b>	Blank
<b>Range</b>	Not Applicable
<b>Example</b>	network.ipv6_primary_dns = 3036:1:1:c3c7: c11c:5447:23a6:256

<b>Parameter-</b> network.ipv6_secondary_dns	<b>Configuration File</b> <MAC>.cfg
<b>Description</b>	Configures the secondary DNS server when the IPv6 address assignment method is configured as Static IP Address and the IP add mode is configured as IPv6 or IPv4&IPv6. <b>Note:</b> If you change this parameter, the IP phone will reboot to make the change take effect.
<b>Format</b>	IP Address

<b>Default Value</b>	Blank
<b>Range</b>	Not Applicable
<b>Example</b>	network.ipv6_secondary_dns = 2026:1234:1:1:c3c7:c11c:5447:23a6

## Audio Feature Parameters

### Head Prior

Parameter-	Configuration File
features.headset_prior	<y0000000000xx>.cfg
<b>Description</b>	Enables or disables headset prior feature. If set to 1 (enabled), a user needs to press the HEADSET key to activate the headset mode. The headset mode will not be deactivated until the user presses the HEADSET key again.
<b>Format</b>	Boolean
<b>Default Value</b>	0
<b>Range</b>	0-Disabled 1-Enabled
<b>Example</b>	features.headset_prior = 1

### Dual Headset

Parameter-	Configuration File
features.headset_training	<y0000000000xx>.cfg
<b>Description</b>	Enables or disables dual headset feature. If set to 1 (Enabled), users can use two headsets on one phone. When the IP phone joins in a cal, the users with the headset connected to the headset jack have a full-duplex conversation, while the users with the headset connected to the handset jack are only allowed to listen to.
<b>Format</b>	Boolean

<b>Default Value</b>	0
<b>Range</b>	0-Disabled 1-Enabled
<b>Example</b>	features.headset_training = 1

## Audio Codecs

<b>Parameter-</b>	<b>Configuration File</b>
account.x.codec.y.enable	<MAC>.cfg
<b>Description</b>	Enables or disables the IP phone to use the specific codec for account x. X ranges from 1 to 6. Y ranges from 1 to 11.
<b>Format</b>	Boolean
<b>Default Value</b>	For SIP-T28P/T26P/T22P/T20P IP phone: When Y=1, the default value is 1; When Y=2, the default value is 1; When Y=3, the default value is 0; When Y=4, the default value is 0; When Y=5, the default value is 1; When Y=6, the default value is 1; When Y=7, the default value is 0; When Y=8, the default value is 0; When Y=9, the default value is 0; When Y=10, the default value is 0; When Y=11, the default value is 0. For SIP-T19P/T21P IP phone: When Y=1, the default value is 1; When Y=2, the default value is 1; When Y=3, the default value is 0; When Y=4, the default value is 0; When Y=5, the default value is 1; When Y=6, the default value is 1; When Y=7, the default value is 0; When Y=8, the default value is 0.
<b>Range</b>	0-Disabled

	1-Enabled
<b>Example</b>	account.1.codec.1.enable = 1

Parameter-	Configuration File
account.x.codec.y.payload_type	<MAC>.cfg
<b>Description</b>	Specifies the codec for account x to use. X ranges from 1 to 6. Y ranges from 1 to 11.
<b>Format</b>	String
<b>Default Value</b>	For SIP-T28P/T26P/T22P/T20P IP phone: When Y=1, the default value is PCMU; When Y=2, the default value is PCMA; When Y=3, the default value is G723_53; When Y=4, the default value is G723_63; When Y=5, the default value is G729; When Y=6, the default value is G722; When Y=7, the default value is iLBC; When Y=8, the default value is G726_16; When Y=9, the default value is G726_24; When Y=10, the default value is G726_32; When Y=11, the default value is G726_40. For SIP-T19P/T21P IP phone: When Y=1, the default value is PCMU; When Y=2, the default value is PCMA; When Y=3, the default value is G723_53; When Y=4, the default value is G723_63; When Y=5, the default value is G729; When Y=6, the default value is G722; When Y=7, the default value is iLBC; When Y=8, the default value is G726_32.
<b>Range</b>	<b>Valid values are:</b> <ul style="list-style-type: none"> <li>• PCMU</li> <li>• PCMA</li> <li>• G729</li> <li>• G722</li> <li>• G723_53</li> <li>• G723_63</li> </ul>



	<ul style="list-style-type: none"> <li>• G726_16</li> <li>• G726_24</li> <li>• G726_32</li> <li>• G726_40</li> <li>• iLBC</li> </ul>
<b>Example</b>	account.1.codec.1.payload_type = G723_53

<b>Parameter-</b> account.x.codec.y.priority	<b>Configuration File</b> <MAC>.cfg
<b>Description</b>	Specifies the priority for the codec. X ranges from 1 to 6. Y ranges from 1 to 11.
<b>Format</b>	Integer
<b>Default Value</b>	<p>For SIP-T28P/T26P/T22P/T20P IP phone:</p> <p>When Y=1, the default value is 1;  When Y=2, the default value is 2;  When Y=3, the default value is 0;  When Y=4, the default value is 0;  When Y=5, the default value is 3;  When Y=6, the default value is 4;  When Y=7, the default value is 0;  When Y=8, the default value is 0;  When Y=9, the default value is 0;  When Y=10, the default value is 0;  When Y=11, the default value is 0.</p> <p>For SIP-T19P/T21P IP phone:</p> <p>When Y=1, the default value is 1;  When Y=2, the default value is 2;  When Y=3, the default value is 0;  When Y=4, the default value is 0;  When Y=5, the default value is 3;  When Y=6, the default value is 4;  When Y=7, the default value is 0;  When Y=8, the default value is 0.</p>
<b>Range</b>	Not Applicable

<b>Example</b>	account.1.codec.1.priority = 1
----------------	--------------------------------

<b>Parameter-</b> account.x.codec.y.rtpmap	<b>Configuration File</b> <MAC>.cfg
<b>Description</b>	Configures the rtpmap. X ranges from 1 to 6. Y ranges from 1 to 11.
<b>Format</b>	Integer
<b>Default Value</b>	<p>For SIP-T28P/T26P/T22P/T20P IP phone:</p> <p>When Y=1, the default value is 0;                      When Y=2, the default value is 8;                      When Y=3, the default value is 4;                      When Y=4, the default value is 4;                      When Y=5, the default value is 18;                      When Y=6, the default value is 9;                      When Y=7, the default value is 102;                      When Y=8, the default value is 112;                      When Y=9, the default value is 102;                      When Y=10, the default value is 99;                      When Y=11, the default value is 104.</p> <p>For SIP-T19P/T21P IP phone:</p> <p>When Y=1, the default value is 0;                      When Y=2, the default value is 8;                      When Y=3, the default value is 4;                      When Y=4, the default value is 4;                      When Y=5, the default value is 18;                      When Y=6, the default value is 9;                      When Y=7, the default value is 106;                      When Y=8, the default value is 2.</p>
<b>Range</b>	0 to 127
<b>Example</b>	account.1.codec.1.rtpmap = 120

## Ptime

Parameter-	Configuration File
account.x.ptime	<MAC>.cfg
Description	Configures the ptime (in milliseconds) for the codec. X ranges from 1 to 6.
Format	Integer
Default Value	20
Range	<b>Valid values are:</b> 0 (Disabled) 10, 20, 30, 40, 50, 60
Example	account.1.ptime = 30

## Acoustic Echo Cancellation

Parameter-	Configuration File
voice.echo_cancellation	<y0000000000xx>.cfg
Description	Enables or disables AEC feature on the IP phone.
Format	Boolean
Default Value	1
Range	<b>0-Disabled</b> <b>1-Enabled</b>
Example	voice.echo_cancellation = 1

## Voice Activity Detection

Parameter-	Configuration File
voice.vad	<y0000000000xx>.cfg
Description	Enables or disables VAD feature on the IP phone.
Format	Boolean
Default Value	0
Range	<b>0-Disabled</b> <b>1-Enabled</b>

<b>Example</b>	voice.vad = 1
----------------	---------------

### Comfort Noise Generation

Parameter-	Configuration File
voice.cng	<y0000000000xx>.cfg
<b>Description</b>	Enables or disables CNG feature on the IP phone.
<b>Format</b>	Boolean
<b>Default Value</b>	1
<b>Range</b>	0-Disabled 1-Enabled
<b>Example</b>	voice.cng = 1

### Jitter Buffer

Parameter-	Configuration File
voice.jib.adaptive	<y0000000000xx>.cfg
<b>Description</b>	Configures the type of jitter buffer.
<b>Format</b>	Integer
<b>Default Value</b>	1
<b>Range</b>	<b>Valid values are:</b> 0-Fixed 1-Adaptive
<b>Example</b>	voice.jib.adaptive = 1

Parameter-	Configuration File
voice.jib.min	<y0000000000xx>.cfg
<b>Description</b>	Configures the minimum delay time for jitter buffer. <b>Note:</b> It works only if the parameter "voice.jib.adaptive" is set to 1 (Adaptive).
<b>Format</b>	Integer
<b>Default Value</b>	60 <b>Note:</b> For the SIP-T19P and SIP-T21P IP

	phones, the default value is 120.
<b>Range</b>	Not Applicable
<b>Example</b>	voice.jib.min = 1

<b>Parameter-</b> voice.jib.max	<b>Configuration File</b> <y0000000000xx>.cfg
<b>Description</b>	Configures the maximum delay time for jitter buffer. <b>Note:</b> It works only if the parameter "voice.jib.adaptive" is set to 1 (Adaptive).
<b>Format</b>	Integer
<b>Default Value</b>	300
<b>Range</b>	Not Applicable
<b>Example</b>	voice.jib.max = 200

<b>Parameter-</b> voice.jib.normal	<b>Configuration File</b> <y0000000000xx>.cfg
<b>Description</b>	Configures the fixed delay time for jitter buffer. <b>Note:</b> It works only if the parameter "voice.jib.adaptive" is set to 0 (Fixed).
<b>Format</b>	Integer
<b>Default Value</b>	120 <b>Note:</b> For the SIP-T19P and SIP-T21P IP phones, the default value is 180.
<b>Range</b>	Not Applicable
<b>Example</b>	voice.jib.normal = 100

## Security Feature Parameters

### TLS

Parameter-	Configuration File
account.x.transport	<MAC>.cfg
Description	Configures the transport type for account x. If set to 2 (TLS), the SIP message of this account will be encrypted after the successful TLS negotiation. X ranges from 1 to 6.
Format	Integer
Default Value	0 (UDP)
Range	<b>Valid values are:</b> 0-UDP 1-TCP 2-TLS 3-DNS-NAPTR
Example	account.1.transport = 2

Parameter-	Configuration File
security.trust_certificates	<y0000000000xx>.cfg
Description	Enables or disables the IP phone to authenticate the connecting server based on the trusted certificates list. <b>Note:</b> If you change this parameter, the IP phone will reboot to make the change take effect.
Format	Boolean
Default Value	1
Range	0-Disabled 1-Enabled
Example	security.trust_certificates = 1

Parameter-	Configuration File
security.ca_cert	<y0000000000xx>.cfg
Description	Specifies the type of certificates the IP phone used to authenticate the connecting server. <b>Note:</b> If you change this parameter, the IP phone will reboot to make the change take effect.
Format	Boolean
Default Value	0
Range	0-Default certificates 1-Custom certificates 2-All certificates
Example	security.ca_cert = 1

Parameter-	Configuration File
security.cn_validation	<y0000000000xx>.cfg
Description	Enables or disables the IP phone to mandatorily validate the CommonName or SubjectAltName of the certificate sent by the connecting server. <b>Note:</b> If you change this parameter, the IP phone will reboot to make the change take effect.
Format	Boolean
Default Value	0
Range	0-Disabled 1-Enabled
Example	security.cn_validation = 1

Parameter-	Configuration File
security.dev_cert	<y0000000000 xx>.cfg
Description	Specifies the type of certificates the IP phone sends for authentication. <b>Note:</b> If you change this parameter, the IP phone will reboot to make the change take effect.

<b>Format</b>	Boolean
<b>Default Value</b>	0
<b>Range</b>	0-Default certificates 1-Custom certificates
<b>Example</b>	security.dev_cert = 1

## Uploading Certificates

Parameter-	Configuration File
trusted_certificates.url	<y0000000000xx>.cfg
<b>Description</b>	Specifies the access URL of the certificate used to authenticate the connecting server. <b>Note:</b> The certificate you want to upload must be in *.pem, *.crt, *.cer or *.der format.
<b>Format</b>	String
<b>Default Value</b>	Blank
<b>Range</b>	Not Applicable
<b>Example</b>	trusted_certificates.url = http://192.168.1.20/tc.crt

Parameter-	Configuration File
server_certificates.url	<y0000000000xx>.cfg
<b>Description</b>	Specifies the access URL of the certificate the IP phone sends for authentication. <b>Note:</b> The certificate you want to upload must be in *.pem or *.cer format.
<b>Format</b>	String
<b>Default Value</b>	Blank
<b>Range</b>	Not Applicable
<b>Example</b>	server_certificates.url = http://192.168.1.20/ca.pem



## S RTP

Parameter-	Configuration File
account.x.srtp_encryption	<MAC>.cfg
<b>Description</b>	Configures whether to use voice encryption service. If the set to 1 (Optional), the IP phone will negotiate with the other IP phone what type of encryption to utilize for the session. If set to 2 (Compulsory), the IP phone is forced to using SRTP during a call. X ranges from 1 to 6.
<b>Format</b>	Integer
<b>Default Value</b>	0
<b>Value</b>	<b>Valid values are:</b> 0-Disabled 1-Optional 2-Compulsory
<b>Example</b>	account.1.srtp_encryption = 2

## Configuring AES Keys

Parameter-	Configuration File
auto_provision.aes_key_16.com	<y0000000000xx>.cfg
<b>Description</b>	Configures the AES key which is used to encrypt or decrypt the <y0000000000xx>.cfg file.
<b>Format</b>	String ( ) ><  "& cannot be included.
<b>Default Value</b>	Blank
<b>Range</b>	16 characters
<b>Example</b>	auto_provision.aes_key_16.com = 0123456789abcdef

Parameter-	Configuration File
auto_provision.aes_key_16.mac	<y0000000000xx>.cfg
<b>Description</b>	Configures the AES key which is used to encrypt or decrypt the <MAC>.cfg file.
<b>Format</b>	String ( ) > <   "& cannot be included.
<b>Default Value</b>	Blank
<b>Range</b>	16 characters
<b>Example</b>	auto_provision.aes_key_16.mac = 0123456789abmins

## Upgrading Firmware

Parameter-	Configuration File
firmware.url	<y0000000000xx>.cfg
<b>Description</b>	Specifies the access URL of the firmware.
<b>Format</b>	String
<b>Default Value</b>	Blank
<b>Range</b>	Not Applicable
<b>Example</b>	firmware.url = http://192.168.1.20/2.71.0.110.rom

Parameter-	Configuration File
auto_provision.mode	<y0000000000xx>.cfg
<b>Description</b>	Specifies the auto provision mode.
<b>Format</b>	Integer
<b>Default Value</b>	0
<b>Range</b>	<b>For SIPT20P/T22P/T26P/T28P IP phone:</b> <b>Valid values are:</b> 0-Disabled 1-Power on (when the IP phone boots) 4-Repeatedly (at a fixed interval) 5-Weekly (at the specified time) 6-Power on + Repeatedly 7-Power on + Weekly

	<b>For SIP-T19P/T21P IP phone:</b> <b>Valid values are:</b> <b>0-Disabled</b> <b>1-Enabled</b>
<b>Example</b>	auto_provision.mode = 1

**For SIP-T20P/T22P/T26P/T28P IP phone**

<b>Parameter-</b>	<b>Configuration File</b>
auto_provision.schedule.periodic_minute	< y0000000000xx >.cfg
<b>Description</b>	Sets the interval (in minutes) for the IP phone to check new configuration files. <b>Note:</b> It works only if the parameter "auto_provision.mode" is set to 4(Repeatedly) or 6 (Power on + Repeatedly).
<b>Format</b>	Integer
<b>Default Value</b>	60
<b>Range</b>	1 to 43200
<b>Example</b>	auto_provision.schedule.periodic_minute = 1000

<b>Parameter-</b>	<b>Configuration File</b>
auto_provision.schedule.time_from	< y0000000000xx >.cfg
<b>Description</b>	Configures the start time of day in 24-hour period for the IP phone to check new configuration files. <b>Note:</b> It works only if the parameter "auto_provision.mode" is set to 5(Weekly) or 7 (Power on + Weekly).
<b>Format</b>	00:00
<b>Default Value</b>	00:00
<b>Range</b>	00:00 to 23:59
<b>Example</b>	auto_provision.schedule.time_from = 01:30

<b>Parameter-</b> auto_provision.schedule.time_to	<b>Configuration File</b> < y0000000000xx >.cfg
<b>Description</b>	Configures the end time of day in 24-hour period for the IP phone to check new configuration files. <b>Note:</b> It works only if the parameter "auto_provision.mode" is set to 5 (Weekly) or 7 (Power on + Weekly).
<b>Format</b>	00:00
<b>Default Value</b>	00:00
<b>Range</b>	00:00 to 23:59
<b>Example</b>	auto_provision.schedule.time_to = 21:30

<b>Parameter-</b> auto_provision.schedule.dayofweek	<b>Configuration File</b> < y0000000000xx >.cfg
<b>Description</b>	Defines the desired day(s) of a week for the IP phone to check new configuration.
<b>Format</b>	Integer
<b>Default Value</b>	0123456
<b>Range</b>	<b>Valid values are:</b> 0-Sunday 1-Monday 2-Tuesday 3-Wednesday 4-Thursday 5-Friday 6-Saturday
<b>Example</b>	auto_provision.schedule.dayofweek = 123

**For T19P and T21P IP Phone**

<b>Parameter-</b> auto_provision.repeat.enable	<b>Configuration File</b> < y0000000000xx >.cfg
<b>Description</b>	Enable or disable the repeatedly mode.
<b>Format</b>	Boolean

<b>Default Value</b>	0
<b>Range</b>	<b>Valid values are:</b> 0-Disabled 1-Enabled
<b>Example</b>	auto_provision.repeat.enable =0

<b>Parameter-</b> auto_provision.repeat.minutes	<b>Configuration File</b> < y0000000000xx >.cfg
<b>Description</b>	Sets the interval (in minutes) for the IP phone to check new configuration files. <b>Note:</b> It works only if the parameter "auto_provision.repeat.enable" is set to 1(Enabled).
<b>Format</b>	Integer
<b>Default Value</b>	1440
<b>Range</b>	1 to 43200
<b>Example</b>	auto_provision.repeat.minutes = 1000

<b>Parameter-</b> auto_provision.weekly.enable	<b>Configuration File</b> < y0000000000xx >.cfg
<b>Description</b>	Enable or disable the weekly mode.
<b>Format</b>	Boolean
<b>Default Value</b>	0
<b>Range</b>	<b>Valid values are:</b> 0-Disabled 1-Enabled
<b>Example</b>	auto_provision.weekly.enable =0

<b>Parameter-</b> auto_provision.weekly.begin_time	<b>Configuration File</b> < y0000000000xx >.cfg
<b>Description</b>	Configures the start time of day in 24-hour period for the IP phone to check new configuration files. <b>Note:</b> It works only if the parameter "auto_provision.weekly.enable" is set to

	1(Enabled).
<b>Format</b>	00:00
<b>Default Value</b>	00:00
<b>Range</b>	00:00 to 23:59
<b>Example</b>	auto_provision.weekly.begin_time = 01:30

<b>Parameter-</b> auto_provision.weekly.end_time	<b>Configuration File</b> < y0000000000xx > .cfg
<b>Description</b>	Configures the end time of day in 24-hour period for the IP phone to check new configuration files. <b>Note:</b> It works only if the parameter "auto_provision.weekly.enable" is set to 1(Enabled).
<b>Format</b>	00:00
<b>Default Value</b>	00:00
<b>Range</b>	00:00 to 23:59
<b>Example</b>	auto_provision.weekly.end_time = 21:30

<b>Parameter-</b> auto_provision.weekly.mask	<b>Configuration File</b> < y0000000000xx > .cfg
<b>Description</b>	Defines the desired day(s) of a week for the IP phone to check new configuration.
<b>Format</b>	Integer
<b>Default Value</b>	0123456
<b>Range</b>	<b>Valid values are:</b> 0-Sunday 1-Monday 2-Tuesday 3-Wednesday 4-Thursday 5-Friday 6-Saturday
<b>Example</b>	auto_provision.weekly.mask = 123

## Resource Files

### Access URL of Replace Rule Template

Parameter-	Configuration File
dialplan_replace_rule.url	<y0000000000xx>.cfg
<b>Description</b>	Specifies the access URL of the replace rule template.
<b>Format</b>	URL
<b>Default Value</b>	Blank
<b>Range</b>	Not Applicable
<b>Example</b>	dialplan_replace_rule.url = http://192.168.10.25/dialplan.xml

### Access URL of Dial-now Template

Parameter-	Configuration File
dialplan_dialnow.url	<y0000000000xx>.cfg
<b>Description</b>	Specifies the access URL of the dial-now template.
<b>Format</b>	URL
<b>Default Value</b>	Blank
<b>Range</b>	Not Applicable
<b>Example</b>	dialplan_dialnow.url = http://192.168.10.25/dialnow.xml

### Access URL of Softkey Layout Template

Parameter-	Configuration File
custom_softkey_call_failed.url	<y0000000000xx>.cfg
<b>Description</b>	Specifies the access URL of the customized file for the soft key presented on the LCD screen when in the CallFailed state.
<b>Format</b>	URL

<b>Default Value</b>	Not Applicable
<b>Range</b>	Not Applicable
<b>Example</b>	The following example uses HTTP to download the CallFailed state file from the "XMLfiles" directory on provisioning server 10.2.8.16 using 8080 port.  custom_softkey_call_failed.url = http://10.2.8.16:8080/XMLfiles/CallFailed.xml

<b>Parameter-</b>	<b>Configuration File</b>
custom_softkey_call_in.url	<y0000000000xx>.cfg
<b>Description</b>	Specifies the access URL of the customized file for the soft key presented on the LCD screen when in the CallIn state.
<b>Format</b>	URL
<b>Default Value</b>	Not Applicable
<b>Range</b>	Not Applicable
<b>Example</b>	The following example uses HTTP to download the CallIn state file from the "XMLfiles" directory on provisioning server 10.2.8.16 using 8080 port.  custom_softkey_call_in.url = http://10.2.8.16:8080/XMLfiles/CallIn.xml

<b>Parameter-</b>	<b>Configuration File</b>
custom_softkey_connecting.url	<y0000000000xx>.cfg
<b>Description</b>	Specifies the access URL of the customized file for the soft key presented on the LCD screen when in the Connecting state.
<b>Format</b>	URL
<b>Default Value</b>	Not Applicable
<b>Range</b>	Not Applicable
<b>Example</b>	The following example uses HTTP to download the Connecting state file from the "XMLfiles" directory on provisioning



	server 10.2.8.16 using 8080 port. custom_softkey_connecting.url = http://10.2.8.16:8080/XMLfiles/Connecting.xml
--	---

Parameter-	Configuration File
custom_softkey_dialing.url	<y0000000000xx>.cfg
<b>Description</b>	Specifies the access URL of the customized file for the soft key presented on the LCD screen when in the Dialing state.
<b>Format</b>	URL
<b>Default Value</b>	Not Applicable
<b>Range</b>	Not Applicable
<b>Example</b>	The following example uses HTTP to download the Dialing state file from the "XMLfiles" directory on provisioning server 10.2.8.16 using 8080 port. custom_softkey_dialing.url = http://10.2.8.16:8080/XMLfiles/Dialing.xml

Parameter-	Configuration File
custom_softkey_ring_back.url	<y0000000000xx>.cfg
<b>Description</b>	Specifies the access URL of the customized file for the soft key presented on the LCD screen when in the RingBack state.
<b>Format</b>	URL
<b>Default Value</b>	Not Applicable
<b>Range</b>	Not Applicable
<b>Example</b>	The following example uses HTTP to download the RingBack state file from the "XMLfiles" directory on provisioning server 10.2.8.16 using 8080 port. custom_softkey_ring_back.url = http://10.2.8.16:8080/XMLfiles/RingBack.xml

Parameter-	Configuration File
custom_softkey_talking.url	<y0000000000xx>.cfg
<b>Description</b>	Specifies the access URL of the customized file for the soft key presented on the LCD screen when in the Talking state.
<b>Format</b>	URL
<b>Default Value</b>	Not Applicable
<b>Range</b>	Not Applicable
<b>Example</b>	The following example uses HTTP to download the Talking state file from the "XMLfiles" directory on provisioning server 10.2.8.16 using 8080 port.  custom_softkey_talking.url = http://10.2.8.16:8080/XMLfiles/Talking.xml

### Access URL of Local Contact File

Parameter-	Configuration File
local_contact.data.url	<y0000000000xx>.cfg
<b>Description</b>	Specifies the access URL of the local contact file.
<b>Format</b>	URL
<b>Default Value</b>	Blank
<b>Range</b>	Not Applicable
<b>Example</b>	local_contact.data.url = http://192.168.10.25/contactData1.xml

### Access URL of Remote XML Phone Book

Parameter-	Configuration File
remote_phonebook.data.x.url	<y0000000000xx>.cfg
<b>Description</b>	Specifies the access URL of the remote XML phone book.  X ranges from 1 to 5.
<b>Format</b>	URL

<b>Default Value</b>	Blank
<b>Range</b>	Not Applicable
<b>Example</b>	remote_phonebook.data.1.url = http://192.168.1.20/phonebook.xml

## Troubleshooting

### Log Settings

<b>Parameter-</b>	<b>Configuration File</b>
syslog.server	<y0000000000xx>.cfg
<b>Description</b>	Specifies the IP address of the syslog server where to export the log files. <b>Note:</b> If you change this parameter, the IP phone will reboot to make the change take effect.
<b>Format</b>	IP Address
<b>Default Value</b>	Blank
<b>Range</b>	0 to 99 characters
<b>Example</b>	syslog.server = 192.168.1.50

<b>Parameter-</b>	<b>Configuration File</b>
syslog.log_level	<y0000000000xx>.cfg
<b>Description</b>	Specifies the severity level of the logs to be reported to a log file. <b>Note:</b> If you change this parameter, the IP phone will reboot to make the change take effect.
<b>Format</b>	Integer
<b>Default Value</b>	3
<b>Range</b>	0 to 6
<b>Example</b>	syslog.log_level = 2

## Watch Dog

<b>Parameter-</b> watch_dog.enable	<b>Configuration File</b> <y0000000000xx>.cfg
<b>Description</b>	Enables or disables Watch Dog feature.
<b>Format</b>	Boolean
<b>Default Value</b>	1
<b>Range</b>	0-Disabled 1-Enabled
<b>Example</b>	watch_dog.enable = 1

## Configuring DSS Key

This section provides the DSS key parameters you can configure on the IP phone. DSS key consists of memory key, line key and programable key. The following table lists the number of DSS keys you can configure for each phone model:

Phone Model	Line Key	Memory Key	Programable Key
T28P	6	10	14
T26P	3	10	14
T22P	3	/	13
T21P	2	/	11
T20P	2	/	9
T19P	/	/	11

**Note** The programmable key takes effect only if the IP phone is idle.

DSS key can be assigned with various key features. The parameters of the DSS key are detailed in the following:

Parameter- memorykey.x.type	Configuration File <y0000000000xx>.cfg
Parameter- linekey.x.type	
Parameter- programablekey.x.type	
<b>Description</b>	<p>Specifies key feature for the DSS key.</p> <p>For the memory key, x ranges from 1 to 10.</p> <p>For the line key, x ranges from 1 to 6.</p> <p>For the programable key, x ranges from 1 to 14.</p> <p><b>For memory and line keys:</b></p> <p><b>Valid types are:</b></p> <ul style="list-style-type: none"> <li>• N/A (default for memory key)</li> <li>• Conference</li> <li>• Forward</li> <li>• Transfer</li> <li>• Hold</li> <li>• DND</li> <li>• Call Return</li> <li>• SMS (not applicable to SIP-T20P)</li> <li>• Directed Pickup</li> <li>• Call Park</li> <li>• DTMF</li> <li>• Voice Mail</li> <li>• Speed Dial</li> <li>• Intercom</li> <li>• Line (default for line key)</li> <li>• BLF</li> <li>• URL (not applicable to SIP-T20P)</li> <li>• Group Listening</li> <li>• XML Group (not applicable to SIP-T20P)</li> <li>• Group Pickup</li> <li>• Multicast Paging</li> <li>• Record</li> <li>• XML Browser (not applicable to SIP-T20P)</li> <li>• URL Record</li> <li>• LDAP (not applicable to SIP-T20P)</li> <li>• Prefix</li> </ul>

	<ul style="list-style-type: none"> <li>• Zero Touch</li> <li>• ACD</li> <li>• Hot Desking</li> <li>• Local Group</li> <li>• Keypad Lock</li> <li>• Custom Button (not applicable to SIP-T20P)</li> <li>• Directory</li> </ul> <p><b>For programmable keys:</b></p> <p><b>Valid types are:</b></p> <ul style="list-style-type: none"> <li>• N/A</li> <li>• History</li> <li>• Menu</li> <li>• Switch Account (not applicable to SIP-T19P)</li> <li>• Forward</li> <li>• DND</li> <li>• Call Return</li> <li>• Prefix</li> <li>• SMS (not applicable to SIP-T20P)</li> <li>• New SMS (not applicable to SIP-T20P)</li> <li>• Directed Pickup</li> <li>• Speed Dial</li> <li>• XML Group (not applicable to SIP-T20P)</li> <li>• XML Directory</li> <li>• Group Pickup</li> <li>• XML Browser (not applicable to SIP-T20P)</li> <li>• LDAP (not applicable to SIP-T19P and SIP-T20P)</li> <li>• Zero Touch</li> <li>• Status</li> <li>• Local Group</li> <li>• Local Directory</li> <li>• Hot Desking</li> <li>• Keypad Lock</li> <li>• Directory</li> </ul>
<b>Format</b>	Integer
<b>Default Value</b>	<p>For the memory key, the default value is 0 (N/A).</p> <p>For the line key, the default value is 15 (Line).</p> <p>For the programmable key,</p> <p>when x=1, the default value is 28.</p> <p>when x=2, the default value is 61.</p> <p>when x=3, the default value is 5.</p> <p>when x=4, the default value is 30.</p>

	<p>when x=5, the default value is 28.</p> <p>when x=6, the default value is 29.</p> <p>when x=7, the default value is 31.</p> <p>when x=8, the default value is 31.</p> <p>when x=9, the default value is 33.</p> <p>when x=10/11/12/13, the default value is 0.</p> <p>when x=14, the default value is 2.</p>
Range	<p><b>Valid values are:</b></p> <p><b>0</b>-N/A (default for memory key)</p> <p><b>1</b>-Conference</p> <p><b>2</b>-Forward</p> <p><b>3</b>-Transfer</p> <p><b>4</b>-Hold</p> <p><b>5</b>-DND</p> <p><b>7</b>-Call Return</p> <p><b>8</b>-SMS</p> <p><b>9</b>-Directed Pickup</p> <p><b>10</b>-Call Park</p> <p><b>11</b>-DTMF</p> <p><b>12</b>-Voice Mail</p> <p><b>13</b>-Speed Dial</p> <p><b>14</b>-Intercom</p> <p><b>15</b>-Line (default for line key)</p> <p><b>16</b>-BLF</p> <p><b>17</b>-URL</p> <p><b>18</b>-Group Listening</p> <p><b>22</b>-XML Group</p> <p><b>23</b>-Group Pickup</p> <p><b>24</b>-Multicast Paging</p> <p><b>25</b>-Record</p> <p><b>27</b>-XML Browser</p> <p><b>28</b>-History</p> <p><b>30</b>-Menu</p> <p><b>31</b>-Switch Account</p> <p><b>33</b>-Status</p> <p><b>34</b>-Hot Desking</p> <p><b>35</b>-URL Record</p> <p><b>38</b>-LDAP</p> <p><b>40</b>-Prefix</p> <p><b>41</b>-Zero Touch</p> <p><b>42</b>-ACD</p> <p><b>45</b>-Local Group</p>

	<b>48</b> -Custom Button <b>50</b> -Keypad Lock <b>61</b> -Directory
<b>Example</b>	memorykey.1.type = 8

<b>Parameter-</b> memorykey.x.line	<b>Configuration File</b> <y0000000000xx>.cfg
<b>Parameter-</b> linekey. x. line	
<b>Parameter-</b> programablekey.x.line	
<b>Description</b>	<p>Specifies the desired line to apply the key feature.</p> <p>For the memory key, x ranges from 1 to 10.</p> <p>For the line key, x ranges from 1 to 6.</p> <p>For the programable key, x ranges from 1 to 14.</p> <p><b>When assigning the following features, you do not need to configure this parameter:</b></p> <ul style="list-style-type: none"> <li>• DTMF</li> <li>• Prefix</li> <li>• XML Browser</li> <li>• LDAP (not applicable to SIP-T19P and SIP-T20P)</li> <li>• Conference</li> <li>• Forward</li> <li>• Hold</li> <li>• DND</li> <li>• Call Return</li> <li>• SMS (not applicable to the SIP-T20P)</li> <li>• Record</li> <li>• URL Record</li> <li>• Multicast Paging</li> <li>• Group Listening</li> <li>• Local Group</li> <li>• XML Group (not applicable to the SIP-T20P)</li> <li>• ACD</li> <li>• Hot Desking</li> <li>• Zero Touch</li> <li>• URL (not applicable to the SIP-T20P)</li> <li>• Keypad Lock</li> <li>• Directory</li> </ul>



<b>Format</b>	Integer
<b>Default Value</b>	For the memory key and programable key, the default value is not applicable. For the line key, when x=1, the default value is 1. When x=2, the default value is 2. ... When x=6, the default value is 6.
<b>Range</b>	<b>Valid values are:</b> 0 to 6 (for T28P) 0 to 3 (for T26P/T20P) 0 to 2 (for T21P/T20P) 0 to 1 (for T19P) <b>0-Line 1</b> <b>1-Line 1</b> <b>2-Line 2</b> ... <b>6-Line 6</b>
<b>Example</b>	memorykey.1.line = 2

<b>Parameter-</b> memorykey.x.value	<b>Configuration File</b> <y0000000000xx>.cfg
<b>Parameter-</b> linekey.x.value	
<b>Parameter-</b> programablekey.x.value	
<b>Description</b>	Specifies the value for some key features. For the memory key, x ranges from 1 to 10. For the line key, x ranges from 1 to 6. For the programable key, x ranges from 1 to 14.
<b>Format</b>	String
<b>Default Value</b>	Blank
<b>Range</b>	Not Applicable
<b>Example</b>	When you assign the Speed Dial to the memory key, this parameter is used to specify the number you want to dial out.

	memorykey.1.value = 1001
--	--------------------------

<b>Parameter-</b> memorykey.x.pickup_value	<b>Configuration File</b> <y0000000000xx>.cfg
<b>Parameter-</b> linekey.x.pickup_value	
<b>Parameter-</b> programablekey.x.value	
<b>Description</b>	Specifies the pickup code for BLF feature. This parameter is only applicable to BLF feature. For the memory key, x ranges from 1 to 10. For the line key, x ranges from 1 to 6. For the programable key, x ranges from 1 to 14.
<b>Format</b>	String
<b>Default Value</b>	Blank
<b>Range</b>	Not Applicable
<b>Example</b>	memorykey.1.pickup_value = *88

<b>Parameter-</b> memorykey.x.xml_phonebook	<b>Configuration File</b> <y0000000000xx>.cfg
<b>Parameter-</b> linekey.x.xml_phonebook	
<b>Parameter-</b> programablekey.x.xml_phonebook	
<b>Description</b>	Specifies the desired group or remote phone book when multiple groups or remote phone books are configured on the IP phone. This parameter is only applicable to Local Group/XML Group features. For the memory key, x ranges from 1 to 10. For the line key, x ranges from 1 to 6. For the programable key, x ranges from 1 to 14. When assigning Local Group feature, valid values are: <b>0</b> -All contacts

	<p>1-First added group  2-Second added group  ...  When assigning XML Group feature, valid values are:  0-First remote phone book  1-Second remote phone book  ...</p>
<b>Format</b>	Integer
<b>Default Value</b>	0
<b>Range</b>	Not Applicable
<b>Example</b>	Specify the second remote phone book. memorykey.1.xml_phonebook = 1

### Keypad Lock Key

<b>Parameter-</b> memorykey.x.type	<b>Configuration File</b> <y0000000000xx>.cfg
<b>Parameter-</b> linekey.x.type	
<b>Parameter-</b> programablekey.x.type	
<b>Description</b>	<p>Configures a DSS key to be <b>Keypad Lock</b> key on the IP phone.</p> <p>The digit <b>50</b> stands for the key type <b>Keypad Lock</b>.</p> <p>For the memory key, x ranges from 1 to 10.  For the line key, x ranges from 1 to 6.  For the programable key, x ranges from 1 to 14.</p>
<b>Format</b>	Integer
<b>Value</b>	50
<b>Example</b>	memorykey.1.type = 50

## DND Key

<b>Parameter-</b> memorykey.x.type	<b>Configuration File</b> <y0000000000xx>.cfg
<b>Parameter-</b> linekey.x.type	
<b>Parameter-</b> programablekey.x.type	
<b>Description</b>	Configures a DSS key to be DND key on the IP phone. The digit <b>5</b> stands for the key type <b>DND</b> . For the memory key, x ranges from 1 to 10. For the line key, x ranges from 1 to 6. For the programable key, x ranges from 1 to 14.
<b>Format</b>	Integer
<b>Value</b>	5
<b>Example</b>	memorykey.1.type = 5

## Directed Call Pickup Key

<b>Parameter-</b> memorykey.x.type	<b>Configuration File</b> <y0000000000xx>.cfg
<b>Parameter-</b> linekey.x.type	
<b>Parameter-</b> programablekey.x.type	
<b>Description</b>	Configures a DSS key to be directed call pickup key on the IP phone. The digit <b>9</b> stands for the key type <b>Directed Pickup</b> . For the memory key, x ranges from 1 to 10. For the line key, x ranges from 1 to 6. For the programable key, x ranges from 1 to 14.
<b>Format</b>	Integer
<b>Value</b>	9

<b>Example</b>	memorykey.1.type = 9
----------------	----------------------

<b>Parameter-</b> memorykey.x.line	<b>Configuration File</b> <y0000000000xx>.cfg
<b>Parameter-</b> linekey.x.line	
<b>Parameter-</b> programablekey.x.line	
<b>Description</b>	Specifies the desired line to apply the directed call pickup key. For the memory key, x ranges from 1 to 10. For the line key, x ranges from 1 to 6. For the programable key, x ranges from 1 to 14.
<b>Format</b>	Integer
<b>Range</b>	<b>Valid values are:</b> 0 to 6 (for T28P) 0 to 3 (for T26P/T20P) 0 to 2 (for T21P/T20P) 0 to 1 (for T19P) <b>0-Line 1</b> <b>1-Line 1</b> <b>2-Line 2</b> ... <b>6-Line 6</b>
<b>Example</b>	memorykey.1.line = 1

<b>Parameter-</b> memorykey.x.value	<b>Configuration File</b> <y0000000000xx>.cfg
<b>Parameter-</b> linekey.x.value	
<b>Parameter-</b> programablekey.x.value	
<b>Description</b>	Specifies the directed call pickup feature code followed by the number of monitored extension. For the memory key, x ranges from 1 to 10.

	For the line key, x ranges from 1 to 6. For the programmable key, x ranges from 1 to 14.
<b>Format</b>	String
<b>Range</b>	Not Applicable
<b>Example</b>	memorykey.1.value = *971001

### Group Call Pickup Key

<b>Parameter-</b> memorykey.x.type	<b>Configuration File</b> <y0000000000xx>.cfg
<b>Parameter-</b> linekey.x.type	
<b>Parameter-</b> programablekey.x.type	
<b>Description</b>	Configures a DSS key to be group call pickup key on the IP phone. The digit <b>23</b> stands for the key type <b>Group Pickup</b> . For the memory key, x ranges from 1 to 10. For the line key, x ranges from 1 to 6. For the programmable key, x ranges from 1 to 14.
<b>Format</b>	Integer
<b>Value</b>	23
<b>Example</b>	memorykey.1.type = 23

<b>Parameter-</b> memorykey.x.line	<b>Configuration File</b> <y0000000000xx>.cfg
<b>Parameter-</b> linekey.x.line	
<b>Parameter-</b> programablekey.x.line	
<b>Description</b>	Specifies the desired line to apply the group call pickup key. For the memory key, x ranges from 1 to 10. For the line key, x ranges from 1 to 6.

	For the programmable key, x ranges from 1 to 14.
<b>Format</b>	Integer
<b>Range</b>	<p><b>Valid values are:</b></p> <p>0 to 6 (for T28P)  0 to 3 (for T26P/T20P)  0 to 2 (for T21P/T20P)  0 to 1 (for T19P)</p> <p><b>0-Line 1</b>  <b>1-Line 1</b>  <b>2-Line 2</b>  ...  <b>6-Line 6</b></p>
<b>Example</b>	memorykey.1.line = 1

<b>Parameter-</b> memorykey.x.value	<b>Configuration File</b> <y0000000000xx>.cfg
<b>Parameter-</b> linekey.x.value	
<b>Parameter-</b> programmablekey.x.value	
<b>Description</b>	<p>Specifies the group call pickup feature code.</p> <p>For the memory key, x ranges from 1 to 10.</p> <p>For the line key, x ranges from 1 to 6.</p> <p>For the programmable key, x ranges from 1 to 14.</p>
<b>Format</b>	String
<b>Range</b>	Not Applicable
<b>Example</b>	memorykey.1.value = *98

## Call Return Key

<b>Parameter-</b> memorykey.x.type	<b>Configuration File</b> <y0000000000xx>.cfg
<b>Parameter-</b> linekey.x.type	
<b>Parameter-</b> programablekey.x.type	
<b>Description</b>	Configures a DSS key to be call return key on the IP phone. The digit <b>7</b> stands for the key type <b>Call Return</b> . For the memory key, x ranges from 1 to 10. For the line key, x ranges from 1 to 6. For the programable key, x ranges from 1 to 14.
<b>Format</b>	Integer
<b>Value</b>	7
<b>Example</b>	memorykey.2.type = 7

## Call Park Key

<b>Parameter-</b> memorykey.x.type	<b>Configuration File</b> <y0000000000xx>.cfg
<b>Parameter-</b> linekey.x.type	
<b>Description</b>	Configures a DSS key to be call park key on the IP phone. The digit <b>10</b> stands for the key type <b>Call Park</b> . For the memory key, x ranges from 1 to 10. For the line key, x ranges from 1 to 6.
<b>Format</b>	Integer
<b>Value</b>	10
<b>Example</b>	memorykey.2.type = 10



<b>Parameter-</b> memorykey.x.line	<b>Configuration File</b> <y0000000000xx>.cfg
<b>Parameter-</b> linekey.x.line	
<b>Description</b>	Specifies the desired line to apply key feature. For the memory key, x ranges from 1 to 10. For the line key, x ranges from 1 to 6. For the programable key, x ranges from 1 to 14.
<b>Format</b>	Integer
<b>Range</b>	<b>Valid values are:</b> 0 to 6 (for T28P) 0 to 3 (for T26P/T20P) 0 to 2 (for T21P/T20P) <b>0</b> -Line 1 <b>1</b> -Line 1 <b>2</b> -Line 2 ... <b>6</b> -Line 6
<b>Example</b>	memorykey.2.line = 0

<b>Parameter-</b> memorykey.x.value	<b>Configuration File</b> <y0000000000xx>.cfg
<b>Parameter-</b> linekey.x.value	
<b>Description</b>	Specifies the value for some key features. For the memory key, x ranges from 1 to 10. For the line key, x ranges from 1 to 6.
<b>Format</b>	String
<b>Range</b>	Not Applicable
<b>Example</b>	memorykey.2.value = *99

## Intercom Key

<b>Parameter-</b> memorykey.x.type	<b>Configuration File</b> <y0000000000xx>.cfg
<b>Parameter-</b> linekey.x.type	
<b>Description</b>	Configures a DSS key to be the intercom key. The digit <b>14</b> stands for the key type <b>Intercom</b> . For the memory key, x ranges from 1 to 10. For the line key, x ranges from 1 to 6.
<b>Format</b>	Integer
<b>Value</b>	14
<b>Example</b>	memorykey.2.type = 14

<b>Parameter-</b> memorykey.x.line	<b>Configuration File</b> <y0000000000xx>.cfg
<b>Parameter-</b> linekey.x.line	
<b>Description</b>	Specifies the desired line to apply the intercom key. For the memory key, x ranges from 1 to 10. For the line key, x ranges from 1 to 6.
<b>Format</b>	Integer
<b>Range</b>	<b>Valid values are:</b> 0 to 6 (for T28P) 0 to 3 (for T26P/T20P) 0 to 2 (for T21P/T20P)  0-Line 1 1-Line 1 2-Line 2 ... 6-Line 6
<b>Example</b>	memorykey.2.line = 1

<b>Parameter-</b>	<b>Configuration File</b>
-------------------	---------------------------

memorykey.x.value	<y0000000000xx>.cfg
<b>Parameter-</b> linekey.x.value	
<b>Description</b>	Specifies the intercom number. For the memory key, x ranges from 1 to 10. For the line key, x ranges from 1 to 6.
<b>Format</b>	String
<b>Range</b>	Not Applicable
<b>Example</b>	memorykey.2.value = 1008

### LDAP Key

<b>Parameter-</b> memorykey.x.type	<b>Configuration File</b> <y0000000000xx>.cfg
<b>Parameter-</b> linekey.x.type	
<b>Parameter-</b> programablekey.x.type	
<b>Description</b>	Configures a DSS key to be LDAP key on the IP phone. The digit <b>38</b> stands for the key type <b>LDAP</b> . For the memory key, x ranges from 1 to 10. For the line key, x ranges from 1 to 6. For the programable key, x ranges from 1 to 14.
<b>Format</b>	Integer
<b>Value</b>	38
<b>Example</b>	memorykey.2.type = 38

## BLF Key

<b>Parameter-</b> memorykey.x.type	<b>Configuration File</b> <y0000000000xx>.cfg
<b>Parameter-</b> linekey.x.type	
<b>Description</b>	Configures a DSS key to be BLF key on the IP phone. The digit <b>16</b> stands for the key type <b>BLF</b> . For the memory key, x ranges from 1 to 10. For the line key, x ranges from 1 to 6.
<b>Format</b>	Integer
<b>Value</b>	16
<b>Example</b>	memorykey.3.type = 16

<b>Parameter-</b> memorykey.x.line	<b>Configuration File</b> <y0000000000xx>.cfg
<b>Parameter-</b> linekey.x.line	
<b>Description</b>	Specifies the desired line to apply the BLF key. For the memory key, x ranges from 1 to 10. For the line key, x ranges from 1 to 6.
<b>Format</b>	Integer
<b>Range</b>	<b>Valid values are:</b> 0 to 6 (for T28P) 0 to 3 (for T26P/T20P) 0 to 2 (for T21P/T20P) <b>0-Line 1</b> <b>1-Line 1</b> <b>2-Line 2</b> ... <b>6-Line 6</b>
<b>Example</b>	memorykey.3.line = 2

<b>Parameter-</b> memorykey.x.value	<b>Configuration File</b> <y0000000000xx>.cfg
<b>Parameter-</b> linekey.x.value	
<b>Description</b>	Specifies the number of the monitored user. For the memory key, x ranges from 1 to 10. For the line key, x ranges from 1 to 6.
<b>Format</b>	String
<b>Range</b>	Not Applicable
<b>Example</b>	memorykey.3.value = 1008

<b>Parameter-</b> memorykey.x.pickup_value	<b>Configuration File</b> <y0000000000xx>.cfg
<b>Parameter-</b> linekey.x.pickup_value	
<b>Description</b>	Specifies the pickup code for the BLF feature. This parameter only applies to the BLF feature. For the memory key, x ranges from 1 to 10. For the line key, x ranges from 1 to 6.
<b>Format</b>	String
<b>Default Value</b>	Blank
<b>Range</b>	Not Applicable
<b>Example</b>	memorykey.3.pickup_value = *88

### ACD Key

<b>Parameter-</b> memorykey.x.type	<b>Configuration File</b> <y0000000000xx>.cfg
<b>Parameter-</b> linekey.x.type	
<b>Description</b>	Configures a DSS key to be an ACD key on the IP phone. The digit <b>42</b> stands for the key type <b>ACD</b> . For the memory key, x ranges from 1 to 10.

	For the line key, x ranges from 1 to 6.
<b>Format</b>	Integer
<b>Value</b>	42
<b>Example</b>	memorykey.2.type = 42

### Multicast Paging Key

<b>Parameter-</b> memorykey.x.type	<b>Configuration File</b> <y0000000000xx>.cfg
<b>Parameter-</b> linekey.x.type	
<b>Description</b>	Configures a DSS key to be a multicast paging key on the IP phone. The digit <b>24</b> stands for the key type <b>Multicast Paging</b> . For the memory key, x ranges from 1 to 10. For the line key, x ranges from 1 to 6.
<b>Format</b>	Integer
<b>Value</b>	24
<b>Example</b>	memorykey.2.type = 24

<b>Parameter-</b> memorykey.x.value	<b>Configuration File</b> <y0000000000xx>.cfg
<b>Parameter-</b> linekey.x.value	
<b>Description</b>	Specifies the multicast IP address and port number. For the memory key, x ranges from 1 to 10. For the line key, x ranges from 1 to 6. <b>Note:</b> The valid multicast IP addresses range from 224.0.0.0 to 239.255.255.255.
<b>Format</b>	IP Address
<b>Range</b>	224.0.0.0 to 239.255.255.255.
<b>Example</b>	memorykey.3.value = 224.5.5.6:10008

## Record Key

<b>Parameter-</b> memorykey.x.type	<b>Configuration File</b> <y0000000000xx>.cfg
<b>Parameter-</b> linekey.x.type	
<b>Description</b>	Configures a DSS key to be a record key on the IP phone. The digit <b>25</b> stands for the key type <b>Record</b> . For the memory key, x ranges from 1 to 10. For the line key, x ranges from 1 to 6.
<b>Format</b>	Integer
<b>Value</b>	25
<b>Example</b>	memorykey.2.type = 25

## URL Record Key

<b>Parameter-</b> memorykey.x.type	<b>Configuration File</b> <y0000000000xx>.cfg
<b>Parameter-</b> linekey.x.type	
<b>Description</b>	Configures a DSS key to be a URL record key on the IP phone. The digit <b>35</b> stands for the key type <b>URL Record</b> . For the memory key, x ranges from 1 to 10. For the line key, x ranges from 1 to 6.
<b>Format</b>	Integer
<b>Value</b>	35
<b>Example</b>	memorykey.2.type = 35

<b>Parameter-</b> memorykey.x.value	<b>Configuration File</b> <y0000000000xx>.cfg
<b>Parameter-</b> linekey.x.value	
<b>Description</b>	Specifies the URL to record a call.

	For the memory key, x ranges from 1 to 10. For the line key, x ranges from 1 to 6.
<b>Format</b>	String
<b>Default Value</b>	Blank
<b>Range</b>	Not Applicable
<b>Example</b>	memorykey.1.value = http://10.1.2.224/phonerecording.cgi

### Hot Desking Key

<b>Parameter-</b> memorykey.x.type	<b>Configuration File</b> <y0000000000xx>.cfg
<b>Parameter-</b> linekey.x.type	
<b>Parameter-</b> programablekey.x.type	
<b>Description</b>	Configures a DSS key to be a hot desking key on the IP phone. The digit <b>34</b> stands for the key type <b>Hot Desking</b> . For the memory key, x ranges from 1 to 10. For the line key, x ranges from 1 to 6. For the programable key, x ranges from 1 to 14.
<b>Format</b>	Integer
<b>Value</b>	34
<b>Example</b>	memorykey.2.type = 34

## Appendix D: SIP (Session Initiation Protocol)

This section describes how Yealink IP phones comply with the IETF definition of SIP as described in RFC 3261.

This section contains compliance information in the following:

- [RFC and Internet Draft Support](#)
- [SIP Request](#)
- [SIP Header](#)
- [SIP Responses](#)



- [SIP Session Description Protocol \(SDP\) Usage](#)

## RFC and Internet Draft Support

The following RFC's and Internet drafts are supported:

- RFC 1321—The MD5 Message-Digest Algorithm
- RFC 2327—SDP: Session Description Protocol
- RFC 2387—The MIME Multipart / Related Content-type
- RFC 2976—The SIP INFO Method
- RFC 3261—SIP: Session Initiation Protocol (replacement for RFC 2543)
- RFC 3262—Reliability of Provisional Responses in the Session Initiation Protocol (SIP)
- RFC 3263—Session Initiation Protocol (SIP): Locating SIP Servers
- RFC 3264—An Offer/Answer Model with the Session Description Protocol (SDP)
- RFC 3265—Session Initiation Protocol (SIP) - Specific Event Notification
- RFC 3311—The Session Initiation Protocol (SIP) UPDATE Method
- RFC 3325—SIP Asserted Identity
- RFC 3515—The Session Initiation Protocol (SIP) Refer Method
- RFC 3555—MIME Type of RTP Payload Formats
- RFC 3611—RTP Control Protocol Extended reports (RTCP XR)
- RFC 3665—Session Initiation Protocol (SIP) Basic Call Flow Examples
- draft-ietf-sip-cc-transfer-05.txt—SIP Call Control - Transfer
- RFC 3725—Best Current Practices for Third Party Call Control (3pcc) in the Session Initiation Protocol (SIP)
- RFC 3842—A Message Summary and Message Waiting Indication Event Package for the Session Initiation Protocol (SIP)
- RFC 3856—A Presence Event Package for Session Initiation Protocol (SIP)
- RFC 3891—The Session Initiation Protocol (SIP) "Replaces" Header
- RFC 3892—The Session Initiation Protocol (SIP) Referred-By Mechanism
- RFC 3968—The Internet Assigned Number Authority (IANA) Header Field Parameter Registry for the Session Initiation Protocol (SIP)
- RFC 3969—The Internet Assigned Number Authority (IANA) Uniform Resource Identifier (URI) Parameter Registry for the Session Initiation Protocol (SIP)
- RFC 4028—Session Timers in the Session Initiation Protocol (SIP)
- RFC 4235—An INVITE-Initiated Dialog Event Package for the Session Initiation Protocol (SIP)
- RFC 4662—Session Initiation Protocol (SIP) Event Notification Extension for Resource

Lists

- draft-levy-sip-diversion-04.txt—Diversion Indication in SIP
- draft-anil-sipping-bla-02.txt—Implementing Bridged Line Appearances (BLA) Using Session Initiation Protocol (SIP)
- draft-ietf-sip-privacy-04.txt—SIP Extensions for Network-Asserted Caller Identity and Privacy within Trusted Networks
- draft-levy-sip-diversion-06.txt—Diversion Indication in SIP
- draft-ietf-sipping-cc-conferencing-03.txt—SIP Call Control - Conferencing for User Agents
- draft-ietf-sipping-rtcp-summary-02.txt —Session Initiation Protocol Package for Voice Quality Reporting Event
- draft-ietf-sip-connect-reuse-04.txt—Connection Reuse in the Session Initiation Protocol (SIP)

To find the applicable Request for Comments (RFC) document, go to <http://www.ietf.org/rfc.html> and enter the RFC number.

## SIP Request

The following SIP request messages are supported:

Method	Supported	Notes
REGISTER	Yes	
INVITE	Yes	Yealink IP phones support mid-call changes such as putting a call on hold as signaled by a new INVITE that contains an existing Call-ID.
ACK	Yes	
CANCEL	Yes	
BYE	Yes	
OPTIONS	Yes	
SUBSCRIBE	Yes	
NOTIFY	Yes	
REFER	Yes	
PRACK	Yes	
INFO	Yes	

Method	Supported	Notes
MESSAGE	Yes	
UPDATE	Yes	
PUBLISH	Yes	

## SIP Header

The following SIP request headers are supported:

Method	Supported	Notes
Accept	Yes	
Alert-Info	Yes	
Allow	Yes	
Allow-Events	Yes	
Authorization	Yes	
Call-ID	Yes	
Call-Info	Yes	
Contact	Yes	
Content-Length	Yes	
Content-Type	Yes	
CSeq	Yes	
Diversion	Yes	
Event	Yes	
Expires	Yes	
From	Yes	
Max-Forwards	Yes	
Min-SE	Yes	
P-Asserted-Identity	Yes	
P-Preferred-Identity	Yes	
Proxy-Authenticate	Yes	
Proxy-Authorization	Yes	
RAck	Yes	

Method	Supported	Notes
Record-Route	Yes	
Refer-To	Yes	
Referred-By	Yes	
Remote-Party-ID	Yes	
Replaces	Yes	
Require	Yes	
Route	Yes	
RSeq	Yes	
Session-Expires	Yes	
Subscription-State	Yes	
Supported	Yes	
To	Yes	
User-Agent	Yes	
Via	Yes	

## SIP Responses

The following SIP responses are supported:

### 1xx Response—Information Responses

1xx Response	Supported	Notes
100 Trying	Yes	
180 Ringing	Yes	
181 Call Is Being Forwarded	Yes	
183 Session Progress	Yes	

### 2xx Response—Successful Responses

2xx Response	Supported	Notes
200 OK	Yes	
202 Accepted	Yes	In REFER transfer.

### 3xx Response—Redirection Responses

3xx Response	Supported	Notes
300 Multiple Choices	Yes	
301 Moved Permanently	Yes	
302 Moved Temporarily	Yes	

## 4xx Response—Request Failure Responses

4xx Response	Supported	Notes
400 Bad Request	Yes	
401 Unauthorized	Yes	
402 Payment Required	Yes	
403 Forbidden	Yes	
404 Not Found	Yes	
405 Method Not Allowed	Yes	
406 Not Acceptable	No	
407 Proxy Authentication Required	Yes	
408 Request Timeout	Yes	
409 Conflict	No	
410 Gone	No	
411 Length Required	No	
413 Request Entity Too Large	No	
414 Request-URI Too Long	Yes	
415 Unsupported Media Type	Yes	
416 Unsupported URI Scheme	No	
420 Bad Extension	No	
421 Extension Required	No	
423 Interval Too Brief	Yes	
480 Temporarily Unavailable	Yes	
481 Call/Transaction Does Not Exist	Yes	
482 Loop Detected	Yes	
483 Too Many Hops	No	
484 Address Incomplete	Yes	
485 Ambiguous	No	
486 Busy Here	Yes	
487 Request Terminated	Yes	
488 Not Acceptable Here	Yes	

4xx Response	Supported	Notes
491 Request Pending	No	
493 Undecipherable	No	

### 5xx Response—Server Failure Responses

5xx Response	Supported	Notes
500 Internal Server Error	Yes	
501 Not Implemented	Yes	
502 Bad Gateway	No	
503 Service Unavailable	No	
504 Gateway Timeout	No	
505 Version Not Supported	No	

### 6xx Response—Global Responses

6xx Response	Supported	Notes
600 Busy Everywhere	Yes	
603 Decline	Yes	
604 Does Not Exist Anywhere	No	
606 Not Acceptable	No	

## SIP Session Description Protocol (SDP) Usage

SDP Headers	Supported
v—Protocol version	Yes
o—Owner/creator and session identifier	Yes
a—Media attribute	Yes
c—Connection information	Yes
m—Media name and transport address	Yes
s—Session name	Yes
t—Active time	Yes

## Appendix E: SIP Call Flows

SIP uses six request methods:

- INVITE—Indicates a user is being invited to participate in a call session.
- ACK—Confirms that the client has received a final response to an INVITE request.
- BYE—Terminates a call and can be sent by either the caller or the callee.
- CANCEL—Cancels any pending searches but does not terminate a call that has already been accepted.
- OPTIONS—Queries the capabilities of servers.
- REGISTER—Registers the address listed in the To header field with a SIP server.

The following types of responses are used by SIP and generated by the IP phone or the SIP server:

- SIP 1xx—Informational Responses
- SIP 2xx—Successful Responses
- SIP 3xx—Redirection Responses
- SIP 4xx—Client Failure Responses
- SIP 5xx—Server Failure Responses
- SIP 6xx—Global Failure Responses



## Successful Call Setup and Disconnect

The following figure illustrates the scenario of a successful call. In this scenario, the two end users are User A and User B. User A and User B are located at Yealink SIP IP phones.

The call flow scenario is as follows:

1. User A calls User B.
2. User B answers the call.
3. User B hangs up.

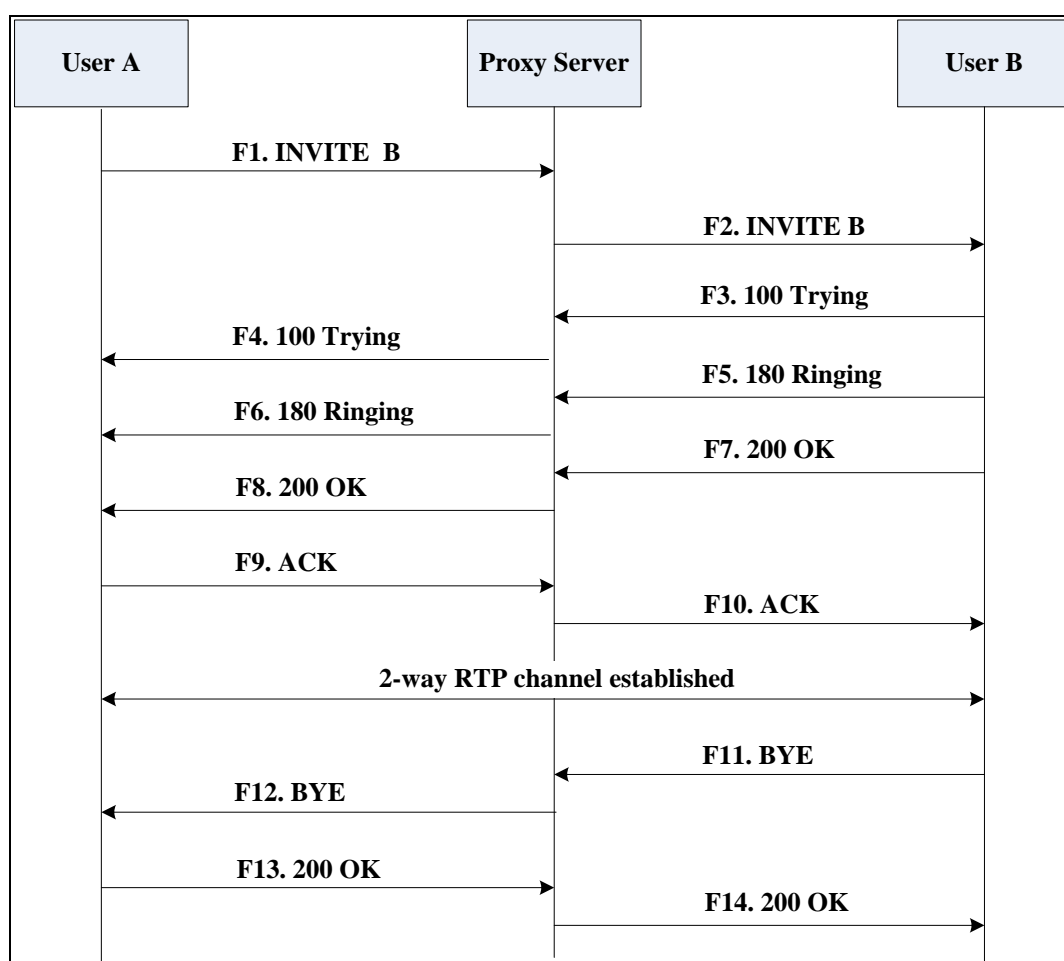

Step	Action	Description
F1	INVITE—User A to Proxy Server	<p>User A sends a SIP INVITE message to a proxy server. The INVITE request is an invitation to User B to participate in a call session.</p> <p>In the INVITE request:</p> <ul style="list-style-type: none"> <li>• The IP address of User B is inserted in the Request-URI field.</li> <li>• User A is identified as the call session initiator in the From field.</li> <li>• A unique numeric identifier is assigned to the call and is inserted in the Call-ID field.</li> <li>• The transaction number within a single call leg is identified in the CSeq field.</li> <li>• The media capability User A is ready to receive is specified.</li> <li>• The port on which User B is prepared to receive the RTP data is specified.</li> </ul>
F2	INVITE—Proxy Server to User B	The proxy server maps the SIP URI in the To field to User B. The proxy server sends the INVITE message to User B.
F3	100 Trying—User B to Proxy Server	User B sends a SIP 100 Trying response to the proxy server. The 100 Trying response indicates that the INVITE request has been received by User B.
F4	100 Trying—Proxy Server to User A	The proxy server forwards the SIP 100 Trying to User A to indicate that the INVITE request has been received by User B.
F5	180 Ringing—User B to Proxy Server	User B sends a SIP 180 Ringing response to the proxy server. The 180 Ringing response indicates that the User B is being alerted.
F6	180 Ringing—Proxy Server to User A	The proxy server forwards the 180 Ringing response to User A. User A hears the ring-back tone indicating that User B is being alerted.

Step	Action	Description
F7	200 OK— User B to Proxy Server	User B sends a SIP 200 OK response to the proxy server. The 200 OK response notifies User A that the connection has been made.
F8	200OK—Proxy Server to User A	The proxy server forwards the 200 OK message to User A. The 200 OK response notifies User A that the connection has been made.
F9	ACK—User A to Proxy Server	User A sends a SIP ACK to the proxy server. The ACK confirms that User A has received the 200 OK response. The call session is now active.
F10	ACK—Proxy Server to User B	The proxy server sends the SIP ACK to User B. The ACK confirms that the proxy server has received the 200 OK response. The call session is now active.
F11	BYE—User B to Proxy Server	User B terminates the call session by sending a SIP BYE request to the proxy server. The BYE request indicates that User B wants to release the call.
F12	BYE—Proxy Server to User A	The proxy server forwards the SIP BYE request to User A to notify that User B wants to release the call.
F13	200 OK—User A to Proxy Server	User A sends a SIP 200 OK response to the proxy server. The 200 OK response indicates that User A has received the BYE request. The call session is now terminated.
F14	200 OK—Proxy Server to User B	The proxy server forwards the SIP 200 OK response to User B to indicate that User A has received the BYE request. The call session is now terminated.

## Unsuccessful Call Setup—Called User is Busy

The following figure illustrates the scenario of an unsuccessful call due to the reason of the called user being busy. In this scenario, the two end users are User A and User B. User A and User B are located at Yealink SIP IP phones.

The call flow scenario is as follows:

1. User A calls User B.
2. User B is busy on the IP phone and unable or unwilling to take another call.  
The call cannot be set up successfully.

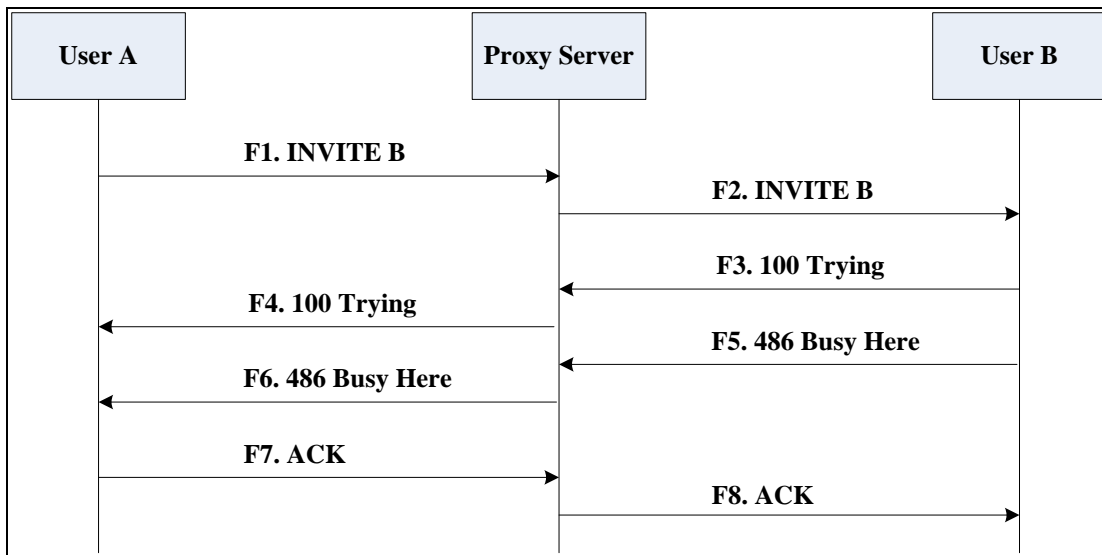

Step	Action	Description
F1	INVITE—User A to Proxy Server	<p>User A sends the INVITE message to a proxy server. The INVITE request is an invitation to User B to participate in a call session.</p> <p>In the INVITE request:</p> <ul style="list-style-type: none"> <li>• The IP address of User B is inserted in the Request-URI field.</li> <li>• User A is identified as the call session initiator in the From field.</li> <li>• A unique numeric identifier is assigned to the call and is inserted in the Call-ID field.</li> <li>• The transaction number within a single call leg is identified in the CSeq field.</li> <li>• The media capability User A is ready to receive is specified.</li> <li>• The port on which User B is prepared to receive the RTP data is specified.</li> </ul>
F2	INVITE—Proxy Server to User B	The proxy server maps the SIP URI in the To field to User B. Proxy server forwards the INVITE message to User B.
F3	100 Trying—User B to Proxy Server	User B sends a SIP 100 Trying response to the proxy server. The 100 Trying response indicates that the INVITE request has been received by User B.
F4	100 Trying—Proxy Server to User A	The proxy server forwards the SIP 100 Trying to User A to indicate that the INVITE request has already been received.
F5	486 Busy Here—User B to Proxy Server	User B sends a SIP 486 Busy Here response to the proxy server. The 486 Busy Here response is a client error response indicating that User B is successfully connected but User B is busy on the IP phone and unable or unwilling to take the call.

Step	Action	Description
F6	486 Busy Here—Proxy Server to User A	The proxy server forwards the 486 Busy Here response to notify User A that User B is busy.
F7	ACK—User A to Proxy Server	User A sends a SIP ACK to the proxy server. The SIP ACK message indicates that User A has received the 486 Busy Here message.
F8	ACK—Proxy Server to User B	The proxy server forwards the SIP ACK to User B to indicate that the 486 Busy Here message has already been received.

## Unsuccessful Call Setup—Called User Does Not Answer

The following figure illustrates the scenario of an unsuccessful call due to the reason of the called user not answering the call. In this scenario, the two end users are User A and User B. User A and User B are located at Yealink SIP IP phones.

The call flow scenario is as follows:

1. User A calls User B.
2. User B does not answer the call.
3. User A hangs up.

The call cannot be set up successfully.

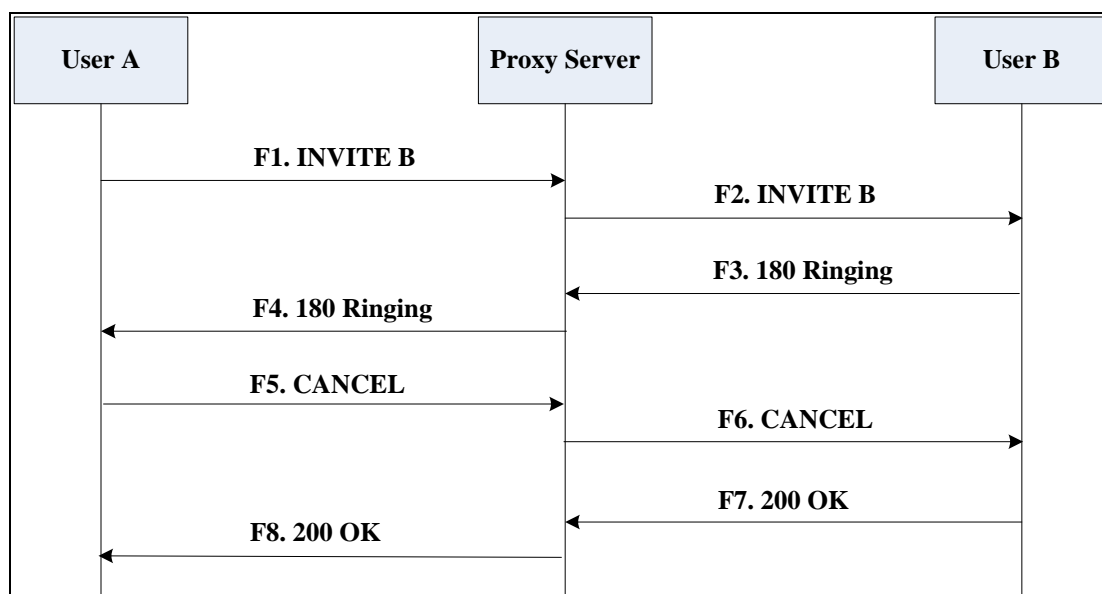

Step	Action	Description
F1	INVITE—User A to Proxy Server	<p>User A sends an INVITE message to a proxy server. The INVITE request is an invitation to User B to participate in a call session.</p> <p>In the INVITE request:</p> <ul style="list-style-type: none"> <li>• The IP address of User B is inserted in the Request-URI field.</li> <li>• User A is identified as the call session initiator in the From field.</li> <li>• A unique numeric identifier is assigned to the call and is inserted in the Call-ID field.</li> <li>• The transaction number within a single call leg is identified in the CSeq field.</li> <li>• The media capability User A is ready to receive is specified.</li> <li>• The port on which User B is prepared to receive the RTP data is specified.</li> </ul>
F2	INVITE—Proxy Server to User B	The proxy server maps the SIP URI in the To field to User B. Proxy server forwards the INVITE message to User B.
F3	180 Ringing—User B to Proxy Server	User B sends a SIP 180 Ringing response to the proxy server. The 180 Ringing response indicates that the user is being alerted.
F4	180 Ringing—Proxy Server to User A	The proxy server forwards the 180 Ringing response to User A. User A hears the ring-back tone indicating that User B is being alerted.
F5	CANCEL—User A to Proxy Server	User A sends a SIP CANCEL request to the proxy server after not receiving an appropriate response within the time allocated in the INVITE request. The SIP CANCEL request indicates that User A wants to disconnect the call.
F6	CANCEL—Proxy Server to	The proxy server forwards the SIP CANCEL request to notify User B that



Step	Action	Description
	User B	User A wants to disconnect the call.
F7	200 OK—User B to Proxy Server	User B sends a SIP 200 OK response to the proxy server. The SIP 200 OK response indicates that User B has received the CANCEL request.
F8	200 OK—Proxy Server to User A	The proxy server forwards the SIP 200 OK response to notify User A that the CANCEL request has been processed successfully.

## Successful Call Setup and Call Hold

The following figure illustrates a successful call setup and call hold. In this scenario, the two end users are User A and User B. User A and User B are located at Yealink SIP IP phones.

The call flow scenario is as follows:

1. User A calls User B.
2. User B answers the call.
3. User A puts User B on hold.

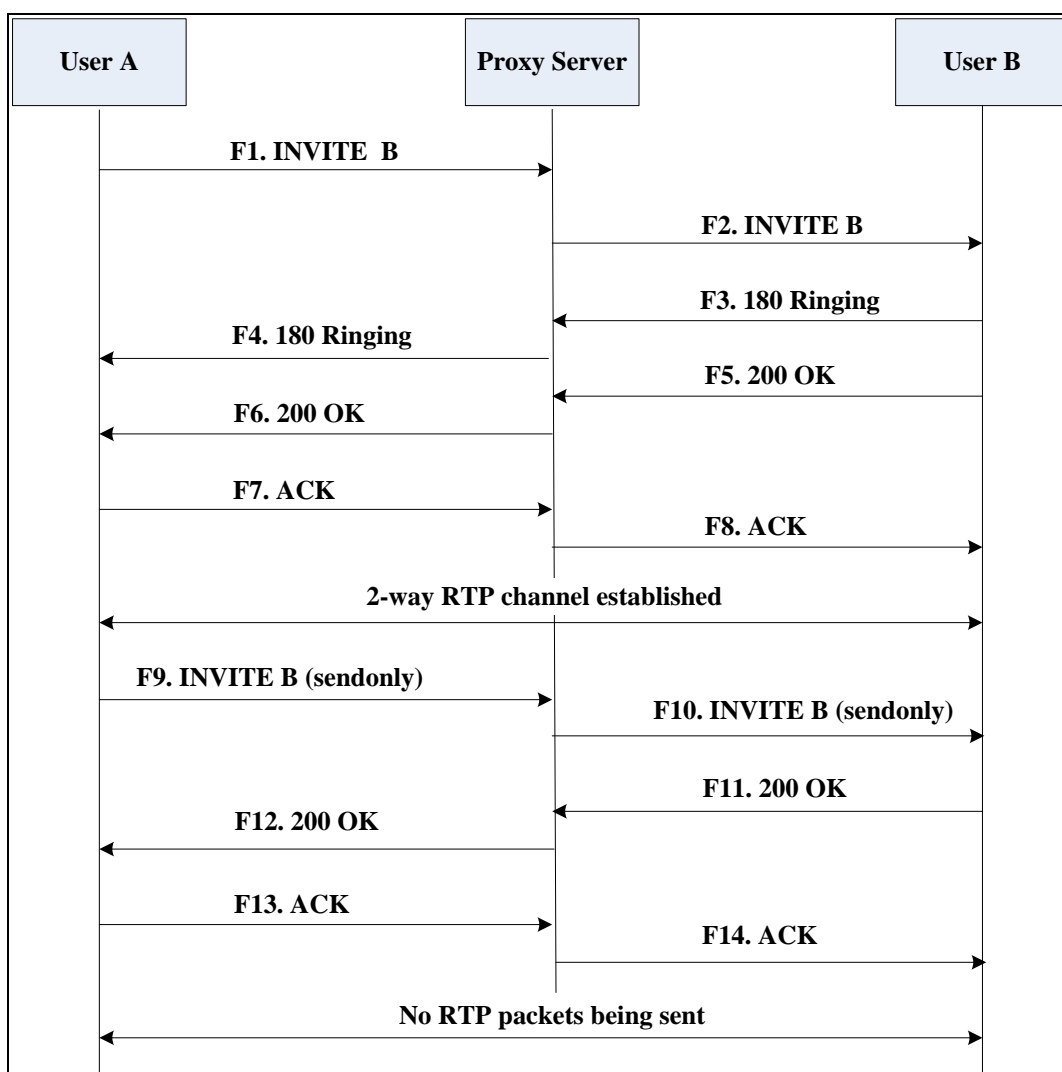

Step	Action	Description
F1	INVITE—User A to Proxy Server	<p>User A sends an INVITE message to a proxy server. The INVITE request is an invitation to User B to participate in a call session.</p> <p>In the INVITE request:</p> <ul style="list-style-type: none"> <li>• The IP address of User B is inserted in the Request-URI field.</li> <li>• User A is identified as the call session initiator in the From field.</li> <li>• A unique numeric identifier is assigned to the call and is inserted in the Call-ID field.</li> <li>• The transaction number within a single call leg is identified in the CSeq field.</li> <li>• The media capability User A is ready to receive is specified.</li> <li>• The port on which User B is prepared to receive the RTP data is specified.</li> </ul>
F2	INVITE—Proxy Server to User B	The proxy server maps the SIP URI in the To field to User B. The proxy server sends the INVITE message to User B.
F3	180 Ringing—User B to Proxy Server	User B sends a SIP 180 Ringing response to the proxy server. The 180 Ringing response indicates that the user is being alerted.
F4	180 Ringing—Proxy Server to User A	The proxy server forwards the 180 Ringing response to User A. User A hears the ring-back tone indicating that User B is being alerted.
F5	200 OK—User B to Proxy Server	User B sends a SIP 200 OK response to the proxy server. The 200 OK response notifies the proxy server that the connection has been made.
F6	200 OK—Proxy Server to User A	The proxy server forwards the 200 OK message to User A. The 200 OK response notifies User A that the connection has been made.

Step	Action	Description
F7	ACK—User A to Proxy Server	User A sends a SIP ACK to the proxy server. The ACK confirms that User A has received the 200 OK response. The call session is now active.
F8	ACK—Proxy Server to User B	The proxy server sends the SIP ACK to User B. The ACK confirms that the proxy server has received the 200 OK response. The call session is now active.
F9	INVITE—User A to Proxy Server	User A sends a mid-call INVITE request to the proxy server with new SDP session parameters, which are used to place the call on hold.
F10	INVITE—Proxy Server to User B	The proxy server forwards the mid-call INVITE message to User B.
F11	200 OK—User B to Proxy Server	User B sends a SIP 200 OK response to the proxy server. The 200 OK response notifies User A that the INVITE is successfully processed.
F12	200 OK—Proxy Server to User A	The proxy server forwards the 200 OK response to User A. The 200 OK response notifies User B is successfully put on hold.
F13	ACK—User A to Proxy Server	User A sends an ACK message to the proxy server. The ACK confirms that User A has received the 200 OK response. The call session is now temporarily inactive. No RTP packets are being sent.
F14	ACK—Proxy Server to User B	The proxy server sends the ACK message to User B. The ACK confirms that the proxy server has received the 200 OK response.

## Successful Call Setup and Call Waiting

The following figure illustrates a successful call between Yealink SIP IP phones in which parties are in a call, one of the participants receives a call from a third party, then answers the incoming call. In this call flow scenario, the end users are User A, User B,

and User C. They are all using Yealink SIP IP phones, which are connected via an IP network.

The call flow scenario is as follows:

1. User A calls User B.
2. User B answers the call.
3. User C calls User B.
4. User B accepts the call from User C.

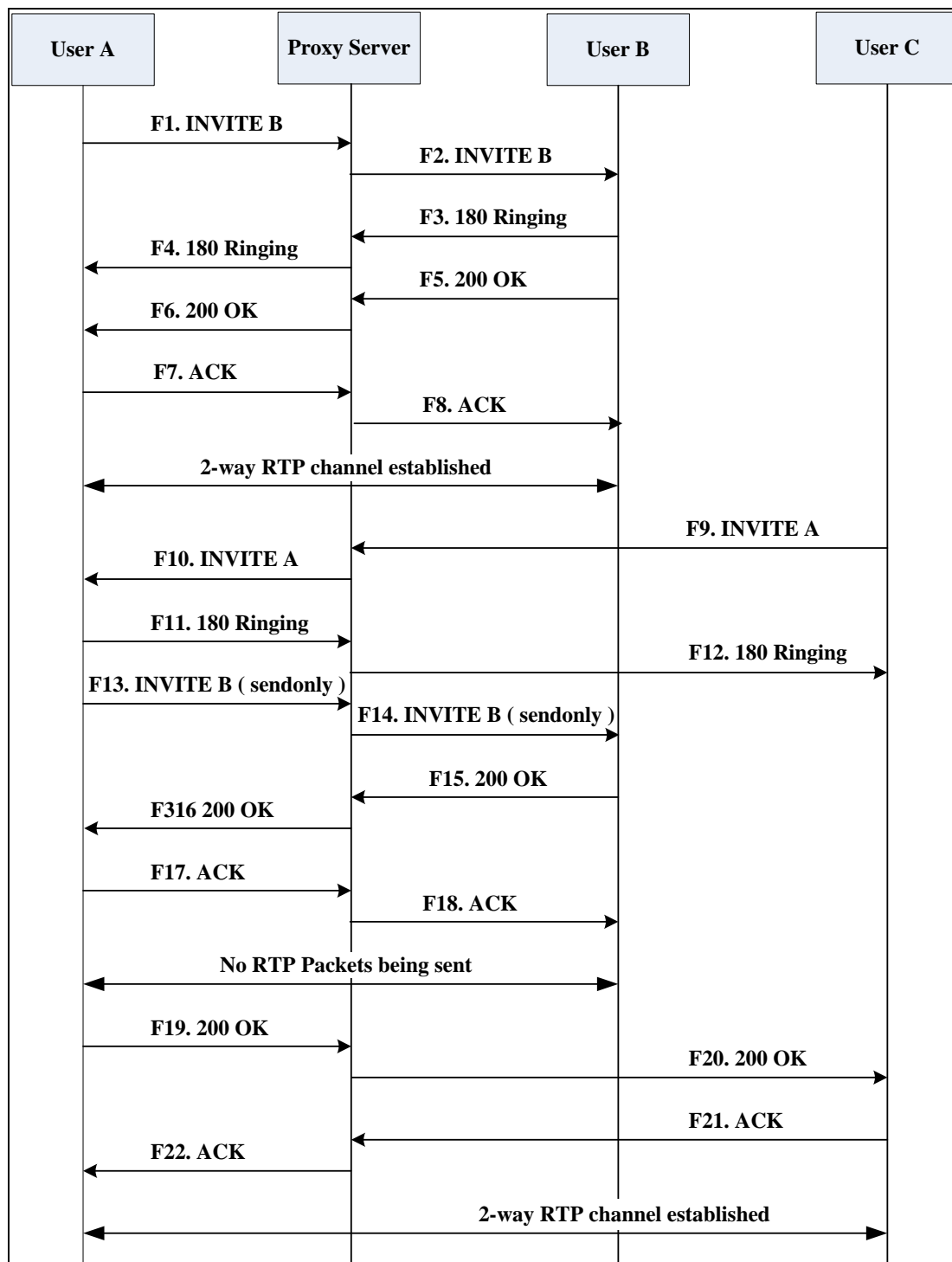

Step	Action	Description
F1	INVITE—User A to Proxy Server	<p>User A sends an INVITE message to a proxy server. The INVITE request is an invitation to User B to participate in a call session.</p> <p>In the INVITE request:</p> <ul style="list-style-type: none"> <li>• The IP address of User B is inserted in the Request-URI field.</li> <li>• User A is identified as the call session initiator in the From field.</li> <li>• A unique numeric identifier is assigned to the call and is inserted in the Call-ID field.</li> <li>• The transaction number within a single call leg is identified in the CSeq field.</li> <li>• The media capability User A is ready to receive is specified.</li> <li>• The port on which User B is prepared to receive the RTP data is specified.</li> </ul>
F2	INVITE—Proxy Server to User B	The proxy server maps the SIP URI in the To field to User B. The proxy server sends the INVITE message to User B.
F3	180 Ringing—User B to Proxy Server	User B sends a SIP 180 Ringing response to the proxy server. The 180 Ringing response indicates that the user is being alerted.
F4	180 Ringing—Proxy Server to User A	The proxy server forwards the 180 Ringing response to User A. User A hears the ring-back tone indicating that User B is being alerted.
F5	200 OK—User B to Proxy Server	User B sends a SIP 200 OK response to the proxy server. The 200 OK response notifies proxy server that the connection has been made.
F6	200 OK—Proxy Server to User A	The proxy server forwards the 200 OK message to User A. The 200 OK response notifies User A that the connection has been made.

Step	Action	Description
F7	ACK—User A to Proxy Server	User A sends a SIP ACK to the proxy server, The ACK confirms that User A has received the 200 OK response. The call session is now active.
F8	ACK—Proxy Server to User B	The proxy server sends the SIP ACK to User B. The ACK confirms that the proxy server has received the 200 OK response. The call session is now active.
F9	INVITE—User C to Proxy Server	<p>User C sends a SIP INVITE message to the proxy server. The INVITE request is an invitation to User A to participate in a call session.</p> <p>In the INVITE request:</p> <ul style="list-style-type: none"> <li>• The IP address of User A is inserted in the Request-URI field.</li> <li>• User C is identified as the call session initiator in the From field.</li> <li>• A unique numeric identifier is assigned to the call and is inserted in the Call-ID field.</li> <li>• The transaction number within a single call leg is identified in the CSeq field.</li> <li>• The media capability User C is ready to receive is specified.</li> <li>• The port on which User A is prepared to receive the RTP data is specified.</li> </ul>
F10	INVITE—Proxy Server to User A	The proxy server maps the SIP URI in the To field to User A. The proxy server sends the INVITE message to User A.
F11	180 Ringing—User A to Proxy Server	User A sends a SIP 180 Ringing response to the proxy server. The 180 Ringing response indicates that the user is being alerted.
F12	180 Ringing—Proxy Server to User C	The proxy server forwards the 180 Ringing response to User C. User C hears the ring-back tone indicating that User A is being alerted.

Step	Action	Description
F13	INVITE—User A to Proxy Server	User A sends a mid-call INVITE request to the proxy server with new SDP session parameters, which are used to place the call on hold.
F14	INVITE—Proxy Server to User B	The proxy server forwards the mid-call INVITE message to User B.
F15	200 OK—User B to Proxy Server	User B sends a 200 OK to the proxy server. The 200 OK response indicates that the INVITE was successfully processed.
F16	200 OK—Proxy Server to User A	The proxy server forwards the 200 OK response to User A. The 200 OK response notifies User B is successfully put on hold.
F17	ACK—User A to Proxy Server	User A sends an ACK message to the proxy server. The ACK confirms that User A has received the 200 OK response. The call session is now temporarily inactive. No RTP packets are being sent.
F18	ACK—Proxy Server to User B	The proxy server sends the ACK message to User B. The ACK confirms that the proxy server has received the 200 OK response.
F19	200 OK—User A to Proxy Server	User A sends a 200 OK response to the proxy server. The 200 OK response notifies that the connection has been made.
F20	200 OK—Proxy Server User C	The proxy server forwards the 200 OK message to User C.
F21	ACK—User C to Proxy Server	User C sends a SIP ACK to the proxy server. The ACK confirms that User C has received the 200 OK response. The call session is now active.
F22	ACK—Proxy Server to User A	The proxy server forwards the SIP ACK to User A to confirm that User C has received the 200 OK response.



## Call Transfer without Consultation

The following figure illustrates a successful call between Yealink SIP IP phones in which two parties are in a call and then one of the parties transfers the call to a third party without consulting the third party. This is called a blind transfer. In this call flow scenario, the end users are User A, User B, and User C. They are all using Yealink SIP IP phones, which are connected via an IP network.

**The call flow scenario is as follows:**

1. User A calls User B.
2. User B answers the call.
3. User B transfers the call to User C.
4. User C answers the call.

Call is established between User A and User C.

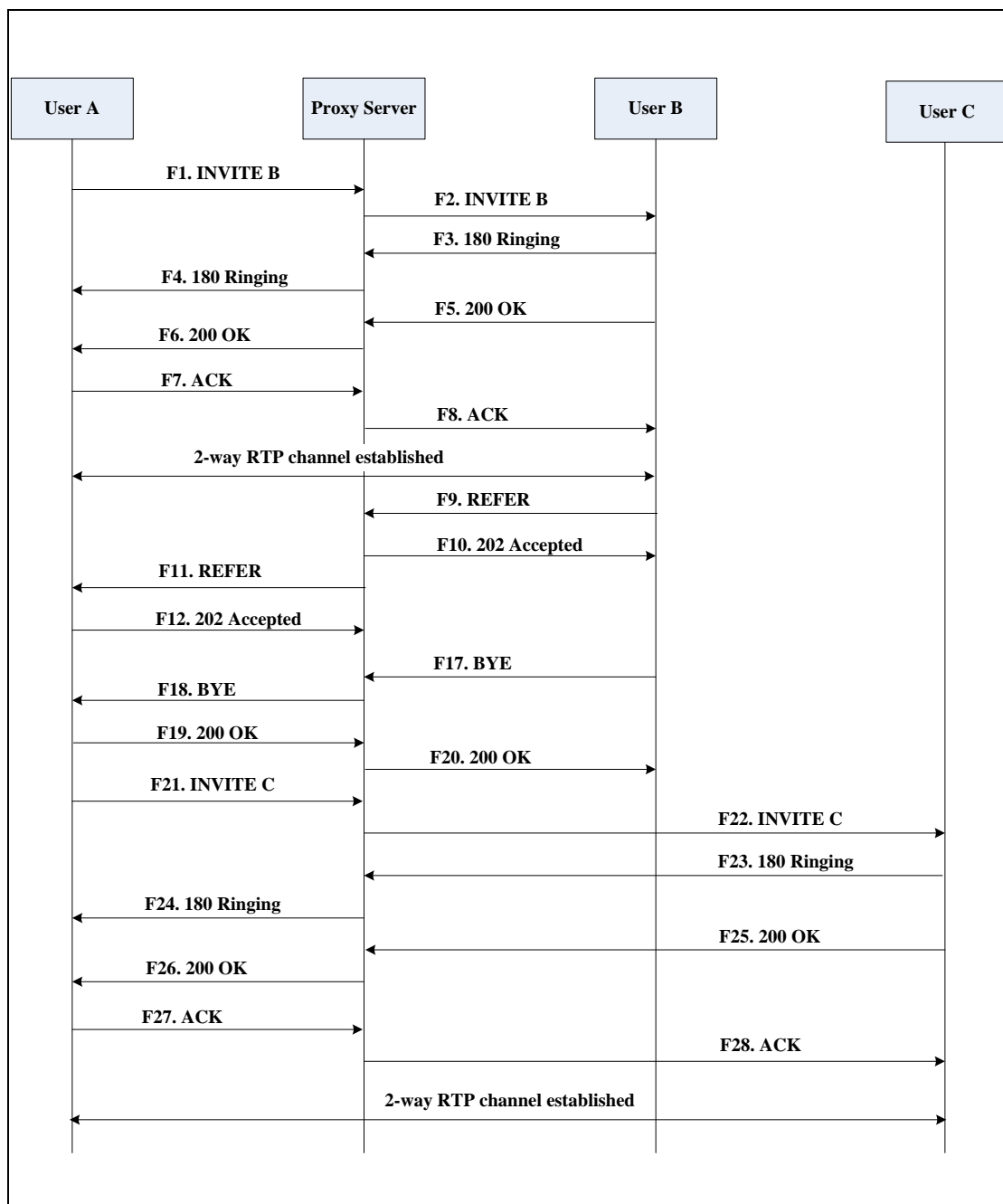

Step	Action	Description
F1	INVITE—User A to Proxy Server	<p>User A sends an INVITE message to the proxy server. The INVITE request is an invitation to User B to participate in a call session.</p> <p>In the INVITE request:</p> <ul style="list-style-type: none"> <li>• The IP address of User B is inserted in the Request-URI field.</li> <li>• User A is identified as the call session initiator in the From field.</li> <li>• A unique numeric identifier is assigned to the call and is inserted in the Call-ID field.</li> <li>• The transaction number within a single call leg is identified in the CSeq field.</li> <li>• The media capability User A is ready to receive is specified.</li> <li>• The port on which User B is prepared to receive the RTP data is specified.</li> </ul>
F2	INVITE—Proxy Server to User B	The proxy server maps the SIP URI in the To field to User B. The proxy server sends the INVITE message to User B.
F3	180 Ringing—User B to Proxy server	User B sends a SIP 180 Ringing response to the proxy server. The 180 Ringing response indicates that the user is being alerted.
F4	180 Ringing—Proxy Server to User A	The proxy server forwards the 180 Ringing response to User A. User A hears the ring-back tone indicating that User B is being alerted.
F5	200 OK—User B to Proxy Server	User B sends a SIP 200 OK response to the proxy server. The 200 OK response notifies User A that the connection has been made.
F6	200 OK—Proxy Server to User A	The proxy server forwards the 200 OK message to User A. The 200 OK response notifies User A that the connection has been made.

Step	Action	Description
F7	ACK—User A to Proxy Server	User A sends a SIP ACK to the proxy server, The ACK confirms that User A has received the 200 OK response. The call session is now active.
F8	ACK—Proxy Server to User B	The proxy server sends the SIP ACK to User B. The ACK confirms that the proxy server has received the 200 OK response. The call session is now active.
F9	REFER—User B to Proxy Server	User B sends a REFER message to the proxy server. User B performs a blind transfer of User A to User C.
F10	202 Accepted—Proxy Server to User B	The proxy server sends a SIP 202 Accept response to User B. The 202 Accepted response notifies User B that the proxy server has received the REFER message.
F11	REFER—Proxy Server to User A	The proxy server forwards the REFER message to User A.
F12	202 Accepted—User A to Proxy Server	User A sends a SIP 202 Accept response to the proxy server. The 202 Accepted response indicates that User A accepts the transfer.
F13	BYE—User B to Proxy Server	User B terminates the call session by sending a SIP BYE request to the proxy server. The BYE request indicates that User B wants to release the call.
F14	BYE—Proxy Server to User A	The proxy server forwards the BYE request to User A.
F15	200OK—User A to Proxy Server	User A sends a SIP 200 OK response to the proxy server. The 200 OK response confirms that User A has received the BYE request.
F16	200OK—Proxy Server to User B	The proxy server forwards the SIP 200 OK response to User B.
F17	INVITE—User A to Proxy Server	User A sends a SIP INVITE request to the proxy server. In the INVITE request, a unique Call-ID is generated and the Contact-URI field indicates that User A

Step	Action	Description
		requests the call.
F18	INVITE—Proxy Server to User C	The proxy server maps the SIP URI in the To field to User C.
F19	180 Ringing—User C to Proxy Server	User C sends a SIP 180 Ringing response to the proxy server. The 180 Ringing response indicates that the user is being alerted.
F20	180 Ringing—Proxy Server to User A	The proxy server forwards the 180 Ringing response to User A. User A hears the ring-back tone indicating that User C is being alerted
F21	200OK—User C to Proxy Server	User C sends a SIP 200 OK response to the proxy server. The 200 OK response notifies the proxy server that the connection has been made.
F22	200OK—Proxy Server to User A	The proxy server forwards the SIP 200 OK response to User A.
F23	ACK— User A to Proxy Server	User A sends a SIP ACK to the proxy server. The ACK confirms that User A has received the 200 OK response. The call session is now active.
F24	ACK—Proxy Server to User C	The proxy server forwards the ACK message to User C. The ACK confirms that User A has received the 200 OK response. The call session is now active.

## Call Transfer with Consultation

The following figure illustrates a successful call between Yealink SIP IP phones in which two parties are in a call and then one of the parties transfers the call to the third party with consultation. This is called attended transfer. In this call flow scenario, the end users are User A, User B, and User C. They are all using Yealink SIP IP phones, which are connected via an IP network.

**The call flow scenario is as follows:**

1. User A calls User B.
2. User B answers the call.
3. User A calls User C.
4. User C answers the call.

5. User A transfers the call to User C.  
Call is established between User B and User C.

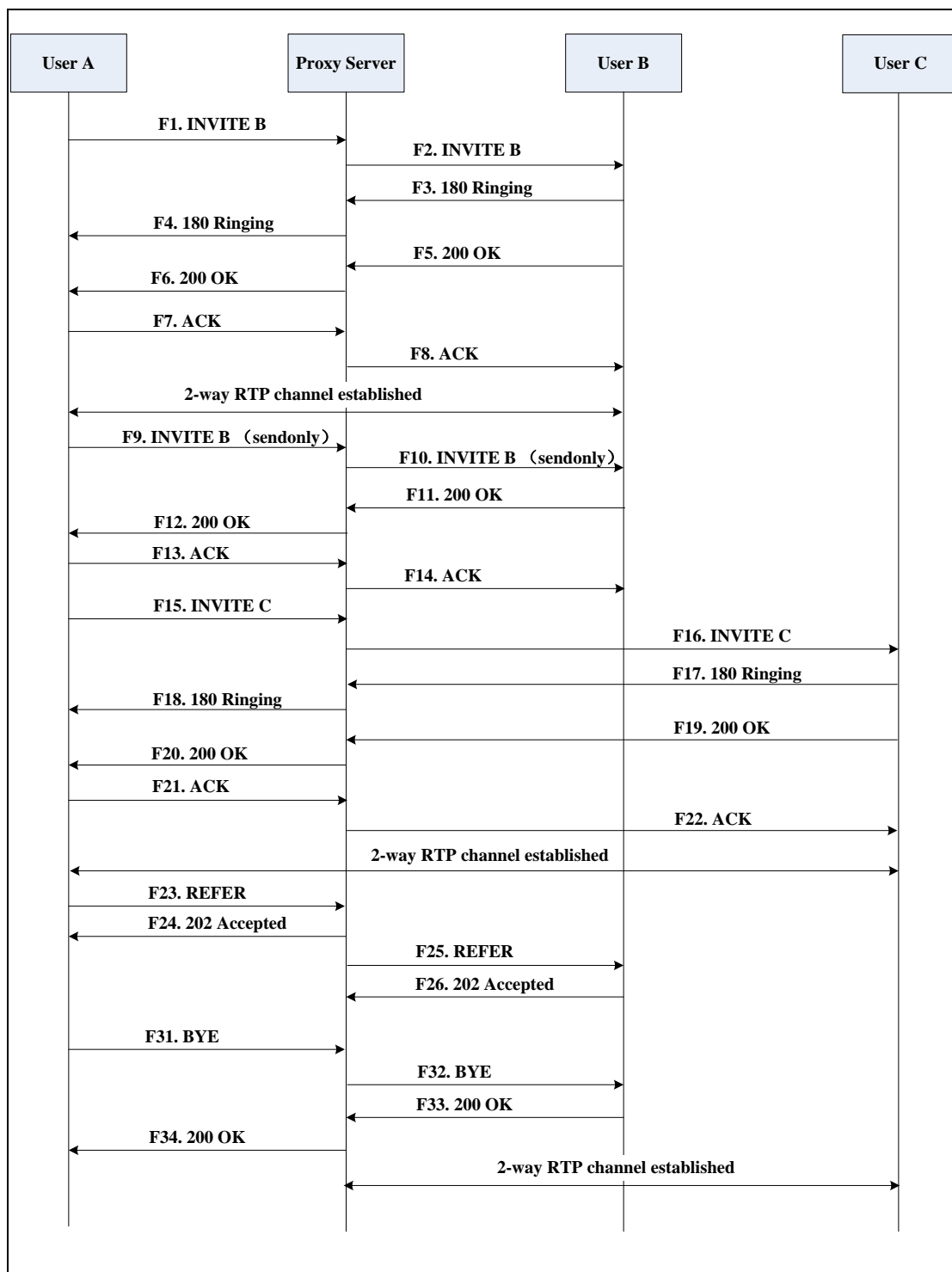

Step	Action	Description
F1	INVITE—User A to Proxy Server	<p>User A sends an INVITE message to a proxy server. The INVITE request is an invitation to User B to participate in a call session.</p> <p>In the INVITE request:</p> <ul style="list-style-type: none"> <li>• The IP address of User B is inserted in the Request-URI field.</li> <li>• User A is identified as the call session initiator in the From field.</li> <li>• A unique numeric identifier is assigned to the call and is inserted in the Call-ID field.</li> <li>• The transaction number within a single call leg is identified in the CSeq field.</li> <li>• The media capability User A is ready to receive is specified.</li> <li>• The port on which User B is prepared to receive the RTP data is specified.</li> </ul>
F2	INVITE—Proxy Server to User B	The proxy server maps the SIP URI in the To field to User B. The proxy server sends the INVITE message to User B.
F3	180 Ringing—User B to Proxy Server	User B sends a SIP 180 Ringing response to the proxy server. The 180 Ringing response indicates that the user is being alerted.
F4	180 Ringing—Proxy Server to User A	The proxy server forwards the 180 Ringing response to User A. User A hears the ring-back tone indicating that User B is being alerted.
F5	200 OK—User B to Proxy Server	User B sends a SIP 200 OK response to the proxy server. The 200 OK response notifies User A that the connection has been made.
F6	200 OK—Proxy Server to User A	The proxy server forwards the 200 OK message to User A. The 200 OK response notifies User A that the connection has been made.

Step	Action	Description
F7	ACK—User A to Proxy Server	User A sends a SIP ACK to the proxy server, The ACK confirms that User A has received the 200 OK response. The call session is now active.
F8	ACK—Proxy Server to User B	The proxy server sends the SIP ACK to User B. The ACK confirms that the proxy server has received the 200 OK response. The call session is now active.
F9	INVITE—User A to Proxy Server	User A sends a mid-call INVITE request to the proxy server with new SDP session parameters, which are used to place the call on hold.
F10	INVITE—Proxy Server to User B	The proxy server forwards the mid-call INVITE message to User B.
F11	200 OK—User B to Proxy Server	User B sends a SIP 200 OK response to the proxy server. The 200 OK response notifies User A that the INVITE was successfully processed.
F12	200 OK—Proxy Server to User A	The proxy server forwards the 200 OK response to User A. The 200 OK response notifies User B is successfully put on hold.
F13	ACK—User A to Proxy Server	User A sends an ACK message to the proxy server. The ACK confirms that User A has received the 200 OK response. The call session is now temporarily inactive. No RTP packets are being sent.
F14	ACK—Proxy Server to User B	The proxy server sends the ACK message to User B. The ACK confirms that the proxy server has received the 200 OK response.
F15	INVITE—User A to Proxy Server	User A sends a SIP INVITE request to the proxy server. In the INVITE request, a unique Call-ID is generated and the Contact-URI field indicates that User A requests the call.
F16	INVITE—Proxy Server to User	The proxy server maps the SIP URI to in the To field to User C. The proxy server



Step	Action	Description
	C	sends the INVITE request to User C.
F17	180 Ringing—User C to Proxy Server	User C sends a SIP 180 Ringing response to the proxy server. The 180 Ringing response indicates that the user is being alerted.
F18	180 Ringing—Proxy Server to User A	The proxy server forwards the 180 Ringing response to User A. User A hears the ring-back tone indicating that User C is being alerted.
F19	200OK—User C to Proxy Server	User C sends a SIP 200 OK response to the proxy server. The 200 OK response notifies User A that the connection has been made.
F20	200OK—Proxy Server to User A	The proxy server forwards the SIP 200 OK response to User A. The 200 OK response notifies User A that the connection has been made.
F21	ACK— User A to Proxy Server	User A sends a SIP ACK to the proxy server. The ACK confirms that User A has received the 200 OK response. The call session is now active.
F22	ACK—Proxy Server to User C	The proxy server forwards the ACK message to User C. The ACK confirms that the proxy server has received the 200 OK response. The call session is now active.
F23	REFER—User A to Proxy Server	User A sends a REFER message to the proxy server. User A performs a transfer of User B to User C.
F24	202 Accepted—Proxy Server to User A	The proxy server sends a SIP 202 Accepted response to User A. The 202 Accepted response notifies User A that the proxy server has received the REFER message.
F25	REFER—Proxy Server to User B	The proxy server forwards the REFER message to User B.
F26	202 Accepted—User B to Proxy Server	User B sends a SIP 202 Accept response to the proxy server. The 202 Accepted

Step	Action	Description
		response indicates that User B accepts the transfer.
F27	BYE—User A to Proxy Server	User A terminates the call session by sending a SIP BYE request to the proxy server. The BYE request indicates that User A wants to release the call.
F28	BYE—Proxy Server to User B	The proxy server forwards the BYE request to User B.
F29	200OK—User B to Proxy Server	User B sends a SIP 200 OK response to the proxy server. The 200 OK response notifies User A that User B has received the BYE request.
F30	200OK—Proxy Server to User A	The proxy server forwards the SIP 200 OK response to User A.

## Always Call Forward

The following figure illustrates successful call forwarding between Yealink SIP IP phones in which User B has enabled always call forward. The incoming call is immediately forwarded to User C when User A calls User B. In this call flow scenario, the end users are User A, User B, and User C. They are all using Yealink SIP IP phones, which are connected via an IP network.

**The call flow scenario is as follows:**

1. User B enables always call forward, and the destination number is User C.
2. User A calls User B.
3. User B forwards the incoming call to User C.
4. User C answers the call.

Call is established between User A and User C.

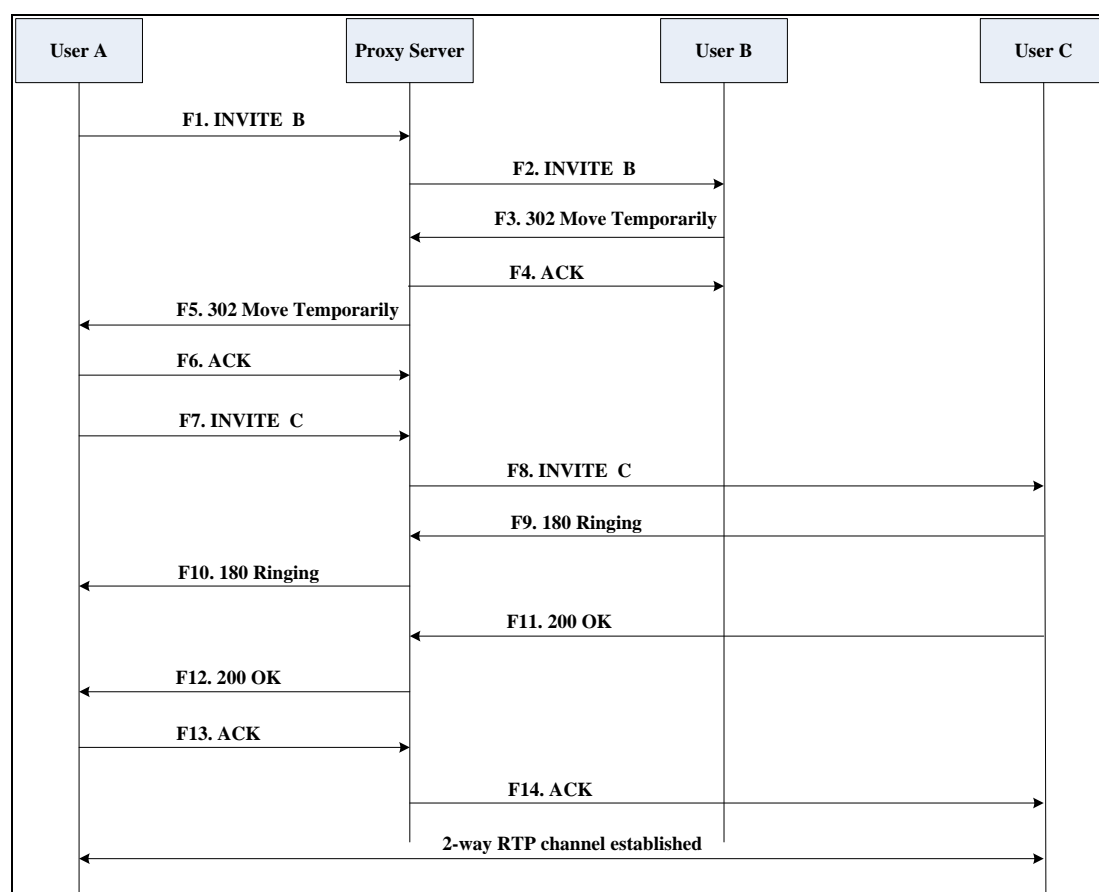

Step	Action	Description
F1	INVITE—User A to Proxy Server	<p>User A sends an INVITE message to a proxy server. The INVITE request is an invitation to User B to participate in a call session.</p> <p>In the INVITE request:</p> <ul style="list-style-type: none"> <li>• The IP address of the User B is inserted in the Request-URI field.</li> <li>• User A is identified as the call session initiator in the From field.</li> <li>• A unique numeric identifier is assigned to the call and is inserted in the Call-ID field.</li> <li>• The transaction number within a single call leg is identified in the CSeq field.</li> <li>• The media capability User A is ready to receive is specified.</li> <li>• The port on which User B is prepared to receive the RTP data is specified.</li> </ul>
F2	INVITE—Proxy Server to User B	The proxy server maps the SIP URI in the To field to User B. The proxy server sends the INVITE message to User B.
F3	302 Move Temporarily—User B to Proxy Server	User B sends a SIP 302 Moved Temporarily message to the proxy server. The message indicates that User B is not available at SIP phone B. User B rewrites the contact-URI.
F4	ACK—Proxy Server to User B	The proxy server sends a SIP ACK to User B, the ACK message notifies User B that the proxy server has received the 302 Move Temporarily message.
F5	302 Move Temporarily—Proxy Server to User A	The proxy server forwards the 302 Moved Temporarily message to User A.
F6	ACK—User A to Proxy Server	User A sends a SIP ACK to the proxy server. The ACK message notifies the proxy server that User A has received the 302 Move Temporarily message.

Step	Action	Description
F7	INVITE—User A to Proxy Server	User A sends a SIP INVITE request to the proxy server. In the INVITE request, a unique Call-ID is generated and the Contact-URI field indicates that User A requested the call.
F8	INVITE—Proxy Server to User C	The proxy server maps the SIP URI in the To field to User C. The proxy server sends the SIP INVITE request to User C.
F9	180 Ringing—User C to Proxy Server	User C sends a SIP 180 Ringing response to the proxy server. The 180 Ringing response indicates that the user is being alerted.
F10	180 Ringing—Proxy Server to User A	The proxy server forwards the 180 Ringing response to User A. User A hears the ring-back tone indicating that User C is being alerted.
F11	200OK—User C to Proxy Server	User C sends a SIP 200 OK response to the proxy server. The 200 OK response notifies User A that the connection has been made.
F12	200OK—Proxy Server to User A	The proxy server forwards the SIP 200 OK response to User A. The 200 OK response notifies User A that the connection has been made.
F13	ACK—User A to Proxy Server	User A sends a SIP ACK to the proxy server. The ACK confirms that User A has received the 200 OK response. The call session is now active.
F14	ACK—Proxy Server to User C	The proxy server forwards the ACK message to User C. The ACK confirms that the proxy server has received the 200 OK response. The call session is now active.

## Busy Call Forward

The following figure illustrates successful call forwarding between Yealink SIP IP phones in which User B has enabled busy call forward. The incoming call is forwarded to User C when User B is busy. In this call flow scenario, the end users are User A, User B, and User C. They are all using Yealink SIP IP phones, which are connected via an IP network.

The call flow scenario is as follows:

1. User B enables busy call forward, and the destination number is User C.
2. User A calls User B.
3. User B is busy.
4. User B forwards the incoming call to User C.
5. User C answers the call.

Call is established between User A and User C.

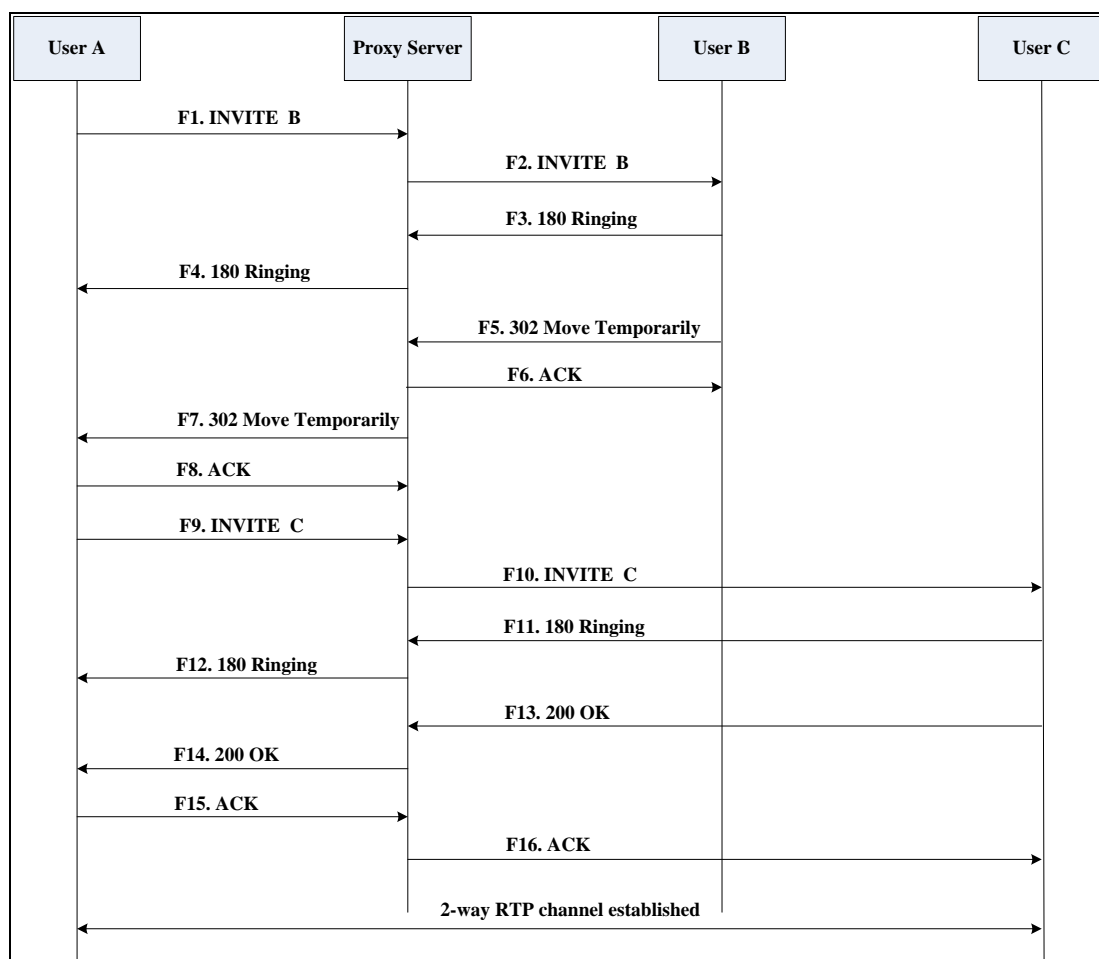

Step	Action	Description
F1	INVITE—User A to Proxy Server	<p>User A sends the INVITE message to a proxy server. The INVITE request is an invitation to User B to participate in a call session.</p> <p>In the INVITE request:</p> <ul style="list-style-type: none"> <li>• The IP address of User B is inserted in the Request-URI field.</li> <li>• User A is identified as the call session initiator in the From field.</li> <li>• A unique numeric identifier is assigned to the call and is inserted in the Call-ID field.</li> <li>• The transaction number within a single call leg is identified in the CSeq field.</li> <li>• The media capability User A is ready to receive is specified.</li> <li>• The port on which User B is prepared to receive the RTP data is specified.</li> </ul>
F2	INVITE—Proxy Server to User B	The proxy server maps the SIP URI in the To field to User B. The proxy server sends the INVITE message to User B.
F3	180 Ringing—User B to Proxy Server	User B sends a SIP 180 Ringing response to the proxy server. The 180 Ringing response indicates that the user is being alerted.
F4	180 Ringing—Proxy Server to User A	The proxy server forwards the 180 Ringing response to User A. User A hears the ring-back tone indicating that User B is being alerted.
F5	302 Move Temporarily—User B to Proxy Server	User B sends a SIP 302 Moved Temporarily message to the proxy server. The message indicates that User B is not available at SIP phone B. User B rewrites the contact-URI.
F6	ACK—Proxy Server to User B	The proxy server sends a SIP ACK to User B, the ACK message notifies User B that the proxy server has received the

Step	Action	Description
		ACK message.
F7	302 Move Temporarily—Proxy Server to User A	The proxy server forwards the 302 Moved Temporarily message to User A.
F8	ACK—User A to Proxy Server	User A sends a SIP ACK to the proxy server. The ACK message notifies the proxy server that User A has received the ACK message.
F9	INVITE—User A to Proxy Server	User A sends a SIP INVITE request to the proxy server. In the INVITE request, a unique Call-ID is generated and the Contact-URI field indicates that User A requests the call.
F10	INVITE—Proxy Server to User C	The proxy server forwards the SIP INVITE request to User C.
F11	180 Ringing—User C to Proxy Server	User C sends a SIP 180 Ringing response to the proxy server. The 180 Ringing response indicates that the user is being alerted.
F12	180 Ringing—Proxy Server to User A	The proxy server forwards the 180 Ringing response to User A. User A hears the ring-back tone indicating that User C is being alerted.
F13	200OK—User C to Proxy Server	User C sends a SIP 200 OK response to the proxy server. The 200 OK response notifies User A that the connection has been made.
F14	200OK—Proxy Server to User A	The proxy server forwards the SIP 200 OK response to User A.
F15	ACK—User A to Proxy Server	User A sends a SIP ACK to the proxy server. The ACK confirms that User A has received the 200 OK response. The call session is now active.
F16	ACK—Proxy Server to User C	The proxy server sends the ACK message to User C.



## No Answer Call Forward

The following figure illustrates successful call forwarding between Yealink SIP IP phones in which User B has enabled no answer call forward. The incoming call is forwarded to User C when User B does not answer the incoming call after a period of time. In this call flow scenario, the end users are User A, User B, and User C. They are all using Yealink SIP IP phones, which are connected via an IP network.

**The call flow scenario is as follows:**

1. User B enables no answer call forward, and the destination number is User C.
2. User A calls User B.
3. User B does not answer the incoming call.
4. User B forwards the incoming call to User C.
5. User C answers the call.

Call is established between User A and User C.

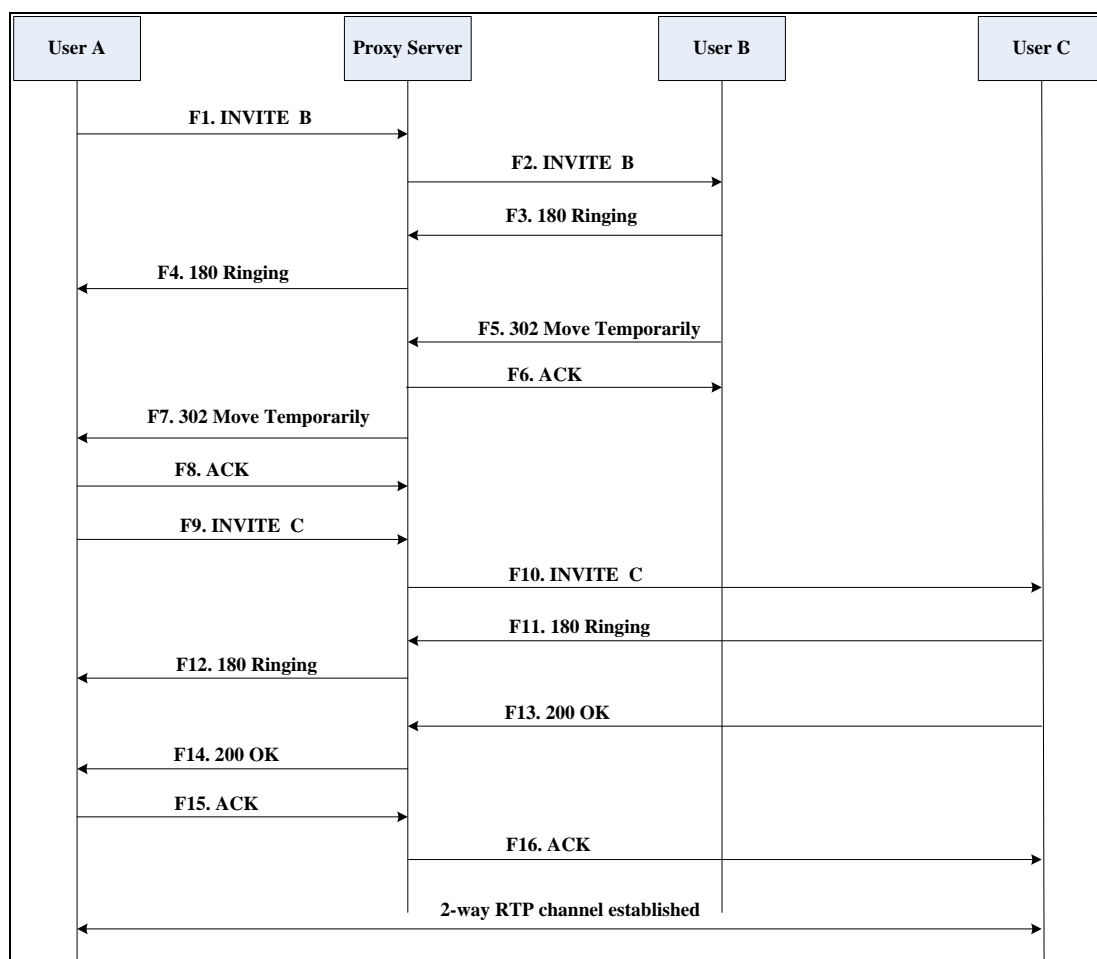

Step	Action	Description
F1	INVITE—User A to Proxy Server	<p>User A sends the INVITE message to a proxy server. The INVITE request is an invitation to User B to participate in a call session.</p> <p>In the INVITE request:</p> <ul style="list-style-type: none"> <li>• The IP address of User B is inserted in the Request-URI field.</li> <li>• User A is identified as the call session initiator in the From field.</li> <li>• A unique numeric identifier is assigned to the call and is inserted in the Call-ID field.</li> <li>• The transaction number within a single call leg is identified in the CSeq field.</li> <li>• The media capability User A is ready to receive is specified.</li> <li>• The port on which User B is prepared to receive the RTP data is specified.</li> </ul>
F2	INVITE—Proxy Server to User B	The proxy server maps the SIP URI in the To field to User B. The proxy server sends the INVITE message to User B.
F3	180 Ringing—User B to Proxy Server	User B sends a SIP 180 Ringing response to the proxy server. The 180 Ringing response indicates that the user is being alerted.
F4	180 Ringing—Proxy Server to User A	The proxy server forwards the 180 Ringing response to User A. User A hears the ring-back tone indicating that User B is being alerted.
F5	302 Move Temporarily—User B to Proxy Server	User B sends a SIP 302 Moved Temporarily message to the proxy server. The message indicates that User B is not available at SIP phone B. User B rewrites the contact-URI.
F6	ACK—Proxy Server to User B	The proxy server sends a SIP ACK to User B, the ACK message notifies User B that the proxy server has received the

Step	Action	Description
		ACK message.
F7	302 Move Temporarily—Proxy Server to User A	The proxy server forwards the 302 Moved Temporarily message to User A.
F8	ACK—User A to Proxy Server	User A sends a SIP ACK to the proxy server. The ACK message notifies the proxy server that User A has received the ACK message.
F9	INVITE—User A to Proxy Server	User A sends a SIP INVITE request to the proxy server. In the INVITE request, a unique Call-ID is generated and the Contact-URI field indicates that User A requests the call.
F10	INVITE—Proxy Server to User C	The proxy server forwards the SIP INVITE request to User C.
F11	180 Ringing—User C to Proxy Server	User C sends a SIP 180 Ringing response to the proxy server. The 180 Ringing response indicates that the user is being alerted.
F12	180 Ringing—Proxy Server to User A	The proxy server forwards the 180 Ringing response to User A. User A hears the ring-back tone indicating that User C is being alerted.
F13	200OK—User C to Proxy Server	User C sends a SIP 200 OK response to the proxy server. The 200 OK response notifies User A that the connection has been made.
F14	200OK—Proxy Server to User A	The proxy server forwards the SIP 200 OK response to User A. The 200 OK response notifies User A that the connection has been made.
F15	ACK—User A to Proxy Server	User A sends a SIP ACK to the proxy server. The ACK confirms that User A has received the 200 OK response. The call session is now active.
F16	ACK—Proxy Server to User C	The proxy server sends the ACK message to User C. The ACK confirms that the proxy server has received the 200 OK response.

## Call Conference

The following figure illustrates successful 3-way calling between Yealink IP phones in which User A mixes two RTP channels and therefore establishes a conference between User B and User C. In this call flow scenario, the end users are User A, User B, and User C. They are all using Yealink SIP IP phones, which are connected via an IP network.

**The call flow scenario is as follows:**

1. User A calls User B.
2. User B answers the call.
3. User A puts User B on hold.
4. User A calls User C.
5. User C answers the call.
6. User A mixes the RTP channels and establishes a conference between User B and User C.

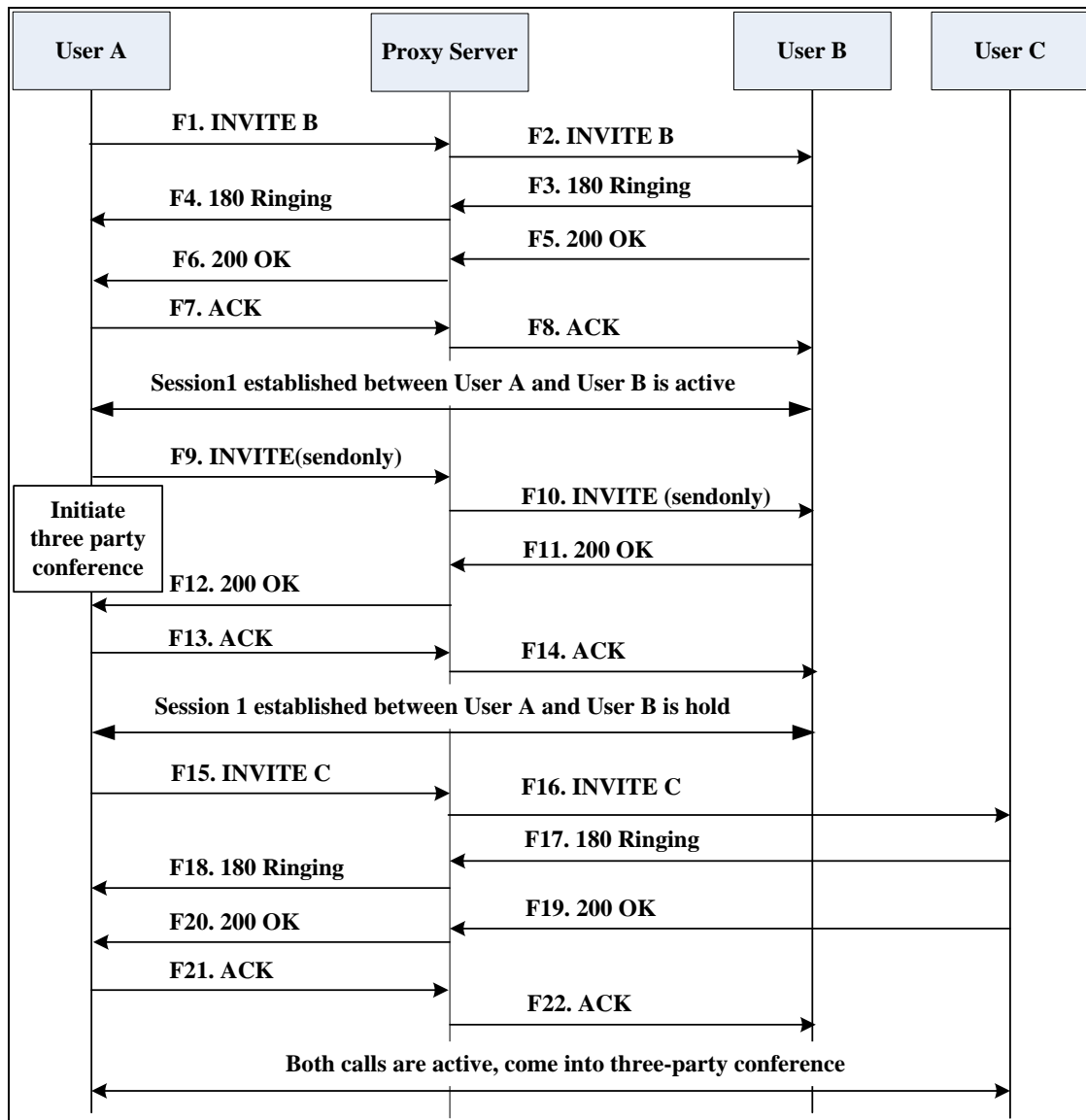

Step	Action	Description
F1	INVITE—User A to Proxy Server	<p>User A sends the INVITE message to a proxy server. The INVITE request is an invitation to User B to participate in a call session.</p> <p>In the INVITE request:</p> <ul style="list-style-type: none"> <li>• The IP address of User B is inserted in the Request-URI field.</li> <li>• User A is identified as the call session initiator in the From field.</li> <li>• A unique numeric identifier is assigned to the call and is inserted in the Call-ID field.</li> <li>• The transaction number within a single call leg is identified in the CSeq field.</li> <li>• The media capability User A is ready to receive is specified.</li> <li>• The port on which User B is prepared to receive the RTP data is specified.</li> </ul>
F2	INVITE—Proxy Server to User B	The proxy server maps the SIP URI in the To field to User B. Proxy server forwards the INVITE message to User B.
F3	180 Ringing—User B to Proxy Server	User B sends a SIP 180 Ringing response to the proxy server. The 180 Ringing response indicates that the user is being alerted.
F4	180 Ringing—Proxy Server to User A	The proxy server forwards the 180 Ringing response to User A. User A hears the ring-back tone indicating that User B is being alerted.
F5	200 OK—User B to Proxy Server	User B sends a SIP 200 OK response to the proxy server. The 200 OK response notifies User A that the connection has been made.
F6	200 OK—Proxy Server to User A	The proxy server forwards the 200 OK message to User A. The 200 OK response notifies User A that the connection has been made.

Step	Action	Description
F7	ACK—User A to Proxy Server	User A sends a SIP ACK to the proxy server. The ACK confirms that User A has received the 200 OK response. The call session is now active.
F8	ACK—Proxy Server to User B	The proxy server sends the SIP ACK to User B. The ACK confirms that the proxy server has received the 200 OK response. The call session is now active.
F9	INVITE—User A to Proxy Server	User A sends a mid-call INVITE request to the proxy server with new SDP session parameters, which are used to place the call on hold.
F10	INVITE—Proxy Server to User B	The proxy server forwards the mid-call INVITE message to User B.
F11	200 OK—User B to Proxy Server	User B sends a SIP 200 OK response to the proxy server. The 200 OK response notifies User A that the INVITE is successfully processed.
F12	200 OK—Proxy Server to User A	The proxy server forwards the 200 OK response to User A. The 200 OK response notifies User A that User B is successfully put on hold.
F13	ACK—User A to Proxy Server	User A sends the ACK message to the proxy server. The ACK confirms that User A has received the 200 OK response. The call session is now temporarily inactive. No RTP packets are being sent.
F14	ACK—Proxy Server to User B	The proxy server sends the ACK message to User B. The ACK confirms that the proxy server has received the 200 OK response.
F15	INVITE—User A to Proxy Server	User A sends a SIP INVITE request to the proxy server. In the INVITE request, a unique Call-ID is generated and the Contact-URI field indicates that User A requests the call.
F16	INVITE—Proxy Server to User	The proxy server maps the SIP URI in the To field to User C. The proxy server

Step	Action	Description
	C	sends the SIP INVITE request to User C.
F17	180 Ringing—User C to Proxy Server	User C sends a SIP 180 Ringing response to the proxy server. The 180 Ringing response indicates that the user is being alerted.
F18	180 Ringing—Proxy Server to User A	The proxy server forwards the 180 Ringing response to User A. User A hears the ring-back tone indicating that User C is being alerted.
F19	200OK—User C to Proxy Server	User C sends a SIP 200 OK response to the proxy server. The 200 OK response notifies User A that the connection has been made.
F20	200OK—Proxy Server to User A	The proxy server forwards the SIP 200 OK response to User A. The 200 OK response notifies User A that the connection has been made.
F21	ACK— User A to Proxy Server	User A sends a SIP ACK to the proxy server. The ACK confirms that User A has received the 200 OK response. The call session is now active.
F22	ACK—Proxy Server to User C	The proxy server sends the ACK message to User C. The ACK confirms that the proxy server has received the 200 OK response.



## Appendix F: Sample Configuration File

This section provides the sample configuration file necessary to configure the IP phone. Any line starts with a pound sign (#) is considered to be a comment, unless the # is contained within double quotes. For Boolean fields, 0 = disabled, 1 = enabled.

This file contains sample configurations for the <y0000000000xx>.cfg or <MAC>.cfg file. The parameters included here are examples only. Not all possible parameters are shown in the sample configuration file. You can configure or comment the values as required. The settings in the <y0000000000xx>.cfg file will be overridden by settings in the <MAC>.cfg file.

### Sample Configuration File

```
#!version:1.0.0.1
#Note: This file header cannot be edited or deleted.

#Network Settings

network.internet_port.type =

#Configure the WAN port type; 0-DHCP, 1-PPPoE, 2-Static IP Address.
#If the WAN port type is configured as DHCP, you do not need to set the
#following network parameters.
#If the WAN port type is configured as Static IP Address, configure the
#following parameters.

network.internet_port.ip =
network.internet_port.mask =
network.internet_port.gateway =
network.primary_dns=
network.secondary_dns =

#If the WAN port type is configured as PPPoE, configure the following
#parameters.
network.pppoe.user =
network.pppoe.password =

#Dial Plan Settings

dialplan.area_code.code =
dialplan.area_code.min_len =
dialplan.area_code.max_len =
dialplan.area_code.line_id =
dialplan.block_out.number.1 =
dialplan.block_out.line_id.1 =
dialnow.item.1 =
dialplan.item.1 =
```

### **#Time Settings**

```
local_time.time_zone =
local_time.time_zone_name =
local_time.ntp_server1 =
local_time.ntp_server2 =
local_time.interval =
local_time.dhcp_time =

#Use the following parameters to set the time and date manually.
local_time.manual_time_enable =
local_time.date_format =
local_time.time_format =
```

### **#Auto DST Settings**

```
local_time.summer_time =
local_time.dst_time_type =
local_time.start_time =
local_time.end_time =
local_time.offset_time =
```

### **#Phone Lock**

```
phone_setting.lock =
phone_setting.phone_lock.unlock_pin =
phone_setting.phone_lock.lock_time_out =
```

### **#Language**

```
lang.wui =
lang.gui =
```

### **#Call Waiting**

```
call_waiting.enable =
call_waiting.tone =
```

### **#Auto Redial**

```
auto_redial.enable =
auto_redial.interval =
auto_redial.times =
```

### **#Call Hold**

```
features.play_hold_tone.enable =
features.play_hold_tone.delay =
sip.rfc2543_hold =
```

**#Hotline**

```
features.hotline_number =  
features.hotline_delay =
```

**#Web Server Type**

```
network.web_server_type =  
network.port.http =  
network.port.https =
```

**#DTMF Suppression**

```
features.dtmf.hide =  
features.dtmf.hide_delay =
```

**#Call Forward****# In Phone Mode**

```
features.fwd_mode = 0  
forward.always.enable =  
forward.always.target =  
forward.always.on_code =  
forward.always.off_code =  
forward.busy.enable =  
forward.busy.target =  
forward.busy.on_code =  
forward.busy.off_code =  
forward.no_answer.enable =  
forward.no_answer.target =  
forward.no_answer.timeout =  
forward.no_answer.on_code =  
forward.no_answer.off_code =
```

**# In Custom Mode**

```
features.fwd_mode = 1  
account.1.always_fwd.enable =  
account.1.always_fwd.target =  
account.1.always_fwd.on_code =  
account.1.busy_fwd.off_code =  
account.1.busy_fwd.enable =  
account.1.busy_fwd.target =  
account.1.busy_fwd.on_code =  
account.1.busy_fwd.off_code =  
account.1.timeout_fwd.enable =  
account.1.timeout_fwd.target =  
account.1.timeout_fwd.timeout =  
account.1.timeout_fwd.on_code =
```

```
account.1.timeout_fwd.off_code =
```

### **#Call Transfer**

```
transfer.semi_attend_tran_enable =  
transfer.blind_tran_on_hook_enable =  
transfer.on_hook_trans_enable =  
transfer.tran_others_after_conf_enable =
```

### **#Call Conference**

```
account.1.conf_type =  
account.1.conf_uri =
```

### **#DTMF**

```
account.1.dtmf.type =  
account.1.dtmf.dtmf_payload =  
account.1.dtmf.info_type =
```

### **#Distinctive Ring Tones**

```
account.1.alert_info_url_enable =  
distinctive_ring_tones.alert_info.1.text =  
distinctive_ring_tones.alert_info.1.ringer =
```

### **#Tones**

```
voice.tone.dial =  
voice.tone.ring =  
voice.tone.busy =  
voice.tone.congestion =  
voice.tone.callwaiting =  
voice.tone.dialrecall =  
voice.tone.record=  
voice.tone.info =  
voice.tone.stutter =  
voice.tone.message =  
voice.tone.autoanswer =
```

### **#Remote Phone Book**

```
features.remote_phonebook.enable =  
features.remote_phonebook.flash_time =
```

### **#LDAP**

```
ldap.name_filter =  
ldap.number_filter =  
ldap.host = 0.0.0.0  
ldap.port = 389
```

```
ldap.base =  
ldap.user =  
ldap.password =  
ldap.max_hits =  
ldap.name_attr =  
ldap.numb_attr =  
ldap.display_name =  
ldap.version =  
ldap.call_in_lookup =  
ldap.ldap_sort =
```

### **#Action URL**

```
action_url.setup_completed =  
action_url.log_on =  
action_url.log_off =  
action_url.register_failed =  
action_url.off_hook =  
action_url.on_hook =  
action_url.incoming_call =  
action_url.outgoing_call =  
action_url.call_established =  
action_url.dnd_on =  
action_url.dnd_off =  
action_url.always_fwd_on =  
action_url.always_fwd_off =  
action_url.busy_fwd_on =  
action_url.busy_fwd_off =  
action_url.no_answer_fwd_on =  
action_url.no_answer_fwd_off =  
action_url.transfer_call =  
action_url.blind_transfer_call =  
action_url.attended_transfer_call =  
action_url.hold =  
action_url.unhold =  
action_url.mute =  
action_url.unmute =  
action_url.missed_call =  
action_url.call_terminated =  
action_url.busy_to_idle =  
action_url.idle_to_busy =  
action_url.forward_incoming_call =  
action_url.reject_incoming_call =  
action_url.answer_new_incoming_call =  
action_url.transfer_finished =
```

```
action_url.transfer_failed =
```

**#SNMP**

```
network.snmp.enable =
```

```
network.snmp.port =
```

```
network.snmp.trust_ip =
```

**#Access URL of Resource Files**

```
dialplan_dialnow.url =
```

```
dialplan_replace_rule.url =
```

```
local_contact.data.url =
```

```
remote_phonebook.data.1.url =
```

# Index

## Numeric

- 180 Ring Workaround [88](#)
- 802.1x Authentication [183](#)

## A

- About This Guide [v](#)
- Acoustic Echo Cancellation [199](#)
- Action URL [157](#)
- Action URI [160](#)
- Administrator Password [46](#)
- Always Forward [96](#)
- Analyzing the Configuration Files [233](#)
- Anonymous Call [79](#)
- Anonymous Call Rejection [80](#)
- Appendix [241](#)
- Appendix A: Glossary [241](#)
- Appendix B: Time Zones [243](#)
- Appendix C: Configuration Parameters [246](#)
- Appendix D: SIP [396](#)
- Appendix E: SIP Call Flows [404](#)
- Appendix F: Sample Configuration File [445](#)
- Area Code [37](#)
- Attach the Stand [13](#)
- Attended Transfer [101](#)
- Audio Codecs [195](#)
- Auto Answer [76](#)
- Auto Redial [75](#)
- Automatic Call Distribution [143](#)

## B

- Backlight [43](#)
- Blind Transfer [101](#)
- Block Out [38](#)
- Busy Forward [96](#)
- Busy Lamp Field [138](#)
- Busy Tone Delay [86](#)

## C

- Call Completion [77](#)
- Call Forward [96](#)
- Call Hold [94](#)
- Call Log [67](#)
- Call Park [113](#)
- Call Recording [152](#)
- Call Return [112](#)
- Call Transfer [101](#)
- Call Waiting [72](#)
- Calling Line Identification Presentation [116](#)
- Connected Line Identification Presentation [118](#)
- Capturing Packets [232](#)
- Comfort Noise Generation [201](#)
- Configuration Files [19](#)
- Configuration Methods [18](#)
- Configuring Advanced features [127](#)
- Configuring Basic Features [41](#)
- Configuring Basic Network Parameters [22](#)
- Configuring Security Features [205](#)
- Connect the Network and Power [13](#)
- Connecting the IP phone [13](#)
- Contrast [42](#)
- Creating Dial Plan [32](#)

## D

- Dial-now [34](#)
- Dial-now Template [222](#)
- Directed Call Pickup [104](#)
- Distinctive Ring Tones [127](#)
- Do Not Disturb (DND) [82](#)
- Documentations [v](#)
- DTMF [118](#)
- Dual Headset [194](#)

## E

- Early Media [88](#)
- Encrypting Configuration Files [213](#)

Enabling the Watch Dog Feature [232](#)

## G

Getting Information from Status Indicators [233](#)

Getting Started [13](#)

Group Call Pickup [107](#)

## H

H.323 [1](#)

Headset Prior [193](#)

Hot Desking [155](#)

Hotline [65](#)

## I

In This Guide [v](#)

Index [451](#)

Initialization Process Overview [16](#)

Intercom [123](#)

IPv6 Support [190](#)

## J

Jitter Buffer [202](#)

## K

Key as Send [63](#)

Key Features of IP Phones [10](#)

## L

Language [55](#)

LDAP [135](#)

Live Dialpad [72](#)

LLDP [169](#)

Loading Language Packs [56](#)

Local Contact File [225](#)

Local Directory [69](#)

Logo Customization [58](#)

## M

Message Waiting Indicator [145](#)

Missed Call Log [68](#)

Multicast Paging [147](#)

Music on Hold [142](#)

## N

NAT Traversal [179](#)

Network Address Translation (NAT) [179](#)

Network Conference [102](#)

No Answer Forward [96](#)

## P

Phone Lock [48](#)

Phone User Interface [18](#)

Physical Features of IP Phones [4](#)

Product Overview [1](#)

## Q

Quality of Service [177](#)

## R

Reading Icons [20](#)

Remote Phone Book [133](#)

Remote XML Phone Book [226](#)

Replace Rule [33](#)

Replace Rule Template [221](#)

Return Message When DND [82](#)

Return Code When Refuse [87](#)

RFC and Internet Draft Support [397](#)

## S

Semi-attended Transfer [101](#)

Server Redundancy [163](#)

Session Timer [92](#)

SIP [1](#)

SIP Components [2](#)

SIP Header [399](#)

SIP IP Phone Models [3](#)

SIP Request [398](#)

SIP Responses [400](#)

SIP Session Description Protocol Usage [403](#)

SIP Session Timer [91](#)

SNMP [181](#)

Softkey Layout [60](#)

Specifying the Language to Use [57](#)



---

S RTP 211  
STUN Server 179  
Suppress DTMF Display 121  
Summary of Changes vi

## T

Table of Contents xi  
Time and Date 50  
Transfer on Conference Hang Up 103  
Transfer via DTMF 122  
Transport Layer Security (TLS) 205  
Troubleshooting 229  
Troubleshooting Methods 229  
Troubleshooting Solutions 234  
TR-069 Device Management 187

## U

Upgrading Firmware 217  
Use Outbound Proxy in Dialog 90  
User Agent Client (UAC) 2  
User Agent Server (UAS) 3  
User Password 45

## V

Verifying Startup 18  
Viewing Log Files 229  
VLAN 172  
Voice Activity Detection 200  
VoIP Principle 1  
VPN 175

## W

Web Server Type 115  
Web User Interface 18